

002-550

Fiberglass Boat Repair & Maintenance

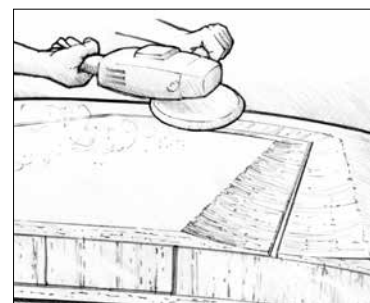
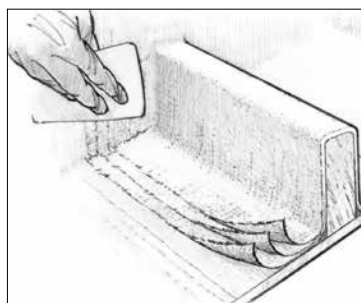
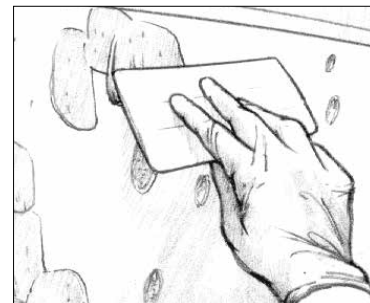
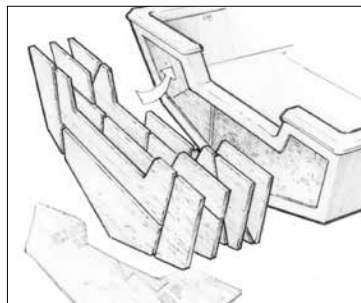
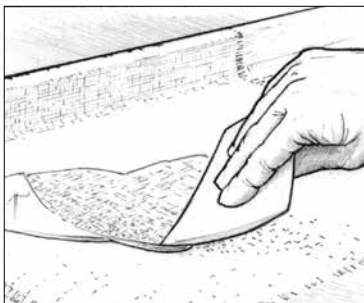
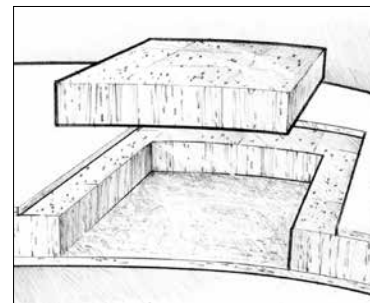
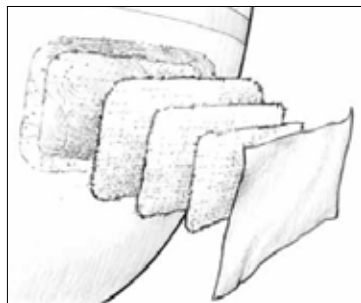
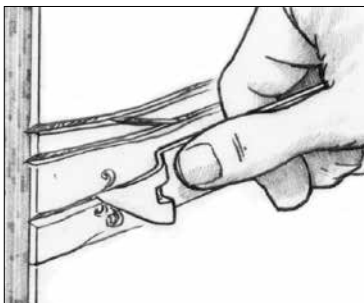
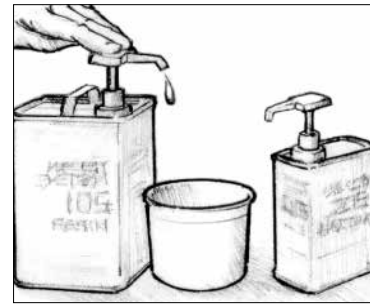
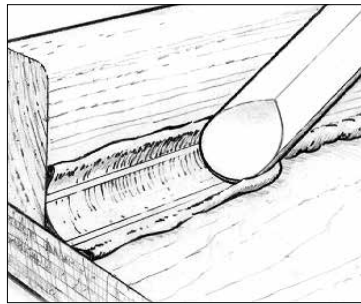
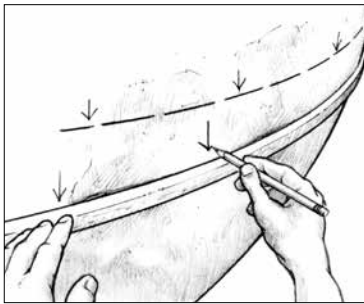

A guide to Fiberglass Boat Repair & Maintenance, Gelcoat Blister Repair and Final Fairing & Finishing with WEST SYSTEM® Epoxy.

1st Edition—December 2014

The techniques described in this manual are based on the handling characteristics and physical properties of WEST SYSTEM Epoxy products. Because physical properties of resin systems and epoxy brands vary, using the techniques in this publication with coatings or adhesives other than WEST SYSTEM is not recommended. This manual is updated as products and techniques change.

The information presented herein is believed to be reliable as of publication date, but we cannot guarantee its accuracy in light of possible new discoveries. Because Gougeon Brothers, Inc. cannot control the use of its products in customer possession, we do not make any warranty of merchantability or fitness for a particular use or purpose. In no event, shall Gougeon Brothers, Inc. be liable for incidental or consequential damages.

WEST SYSTEM, 105 Epoxy Resin, 205 Fast Hardener, 206 Slow Hardener, G/5, G/flex, 410 Microlight and Six10 are registered trademarks of Gougeon Brothers, Inc. Scarffer, 209 Extra Slow Hardener, 207 Special Clear Hardener and 422 Barrier Coat Additive are trademarks of Gougeon Brothers, Inc., Bay City, MI USA.

Copyright © 2014 by Gougeon Brothers, Inc.

Published by Gougeon Brothers, Inc., Bay City, MI USA. All Rights reserved. No part of the contents of this book may be reproduced or transmitted in any form or by any means without the written permission of the publisher.

Printed in the USA.

Table of contents

1	Introduction	
1.1	Typical fiberglass boat construction	1
1.2	WEST SYSTEM Epoxy for fiberglass repair	4
2	Repairing Minor Cracks and Holes	
2.1	Minor crack and abrasion repair	6
3	Repairing Stringers and Floors	
3.1	Reinforcing to improve panel stiffness	8
3.2	Repairing local core damage	9
3.3	Stringer repair guidelines	10
3.4	Replacing active core sections	10
3.5	Replacing stringers	11
3.6	Reinforcing to improve panel stiffness	14
4	Repairing Damaged Skins	
4.1	Assessing and preparing the damaged area	19
4.2	Backing a repair patch	20
4.3	Laminating a repair patch	23
5	Repairing Core Related Damage	
5.1	Repairing skin delamination	26
5.2	Replacing damaged cores	29
5.3	Repairing transom delamination	31
5.4	Repairing holed panels	37
6	Repairing and Upgrading Soles and Decks	
6.1	Repairing delaminated soles and decks	40
6.2	Installing a teak deck	42
7	Installing Hardware	
7.1	Bonding fasteners	45
7.2	Bonding fasteners and hardware	46
7.3	Casting epoxy bases for hardware.	50
7.4	Making fasteners removable	51
7.5	Removing bonded hardware	51

8	Repairing Keels and Rudders	
8.1	Repairing internal ballast keels.	53
8.2	Repairing external ballast keels	54
8.3	Repairing a keel hull joint	55
8.4	Repairing worn rudder bearings	56
9	The Problem of Gelcoat Blisters in Fiberglass Boats	
9.1	Factors affecting blister formation.	58
9.2	WEST SYSTEM Epoxy for repair and coating	61
9.3	Recommendations for the repair and prevention of gelcoat blisters	63
10	Hull Preparation	
10.1	Evaluating blister damage	64
10.2	Minor isolated blister damage	65
10.4	Exposing and removing interlaminar damage	67
10.5	Special preparations for new boats	68
11	Drying the Laminate	
11.1	How dry is dry?	69
11.2	Passive drying	70
11.3	Active drying	70
12	Repairing Blister Damage	
12.1	Minor isolated blister damage	72
12.2	Extensive blister damage	73
12.3	Interlaminar damage	74
13	Barrier Coating	
13.1	Preparation	78
13.2	Applying the barrier coat	79
13.3	Bottom paint	80
13.4	Recommendations for blister prevention	81
14	Final Fairing	
14.1	Establishing a fair level	83
14.2	Removing high areas	84
14.3	Filling low areas	85
14.4	Local fairing	92

15	Finishing	
15.1	Epoxy barrier coating	94
15.2	Final surface preparation	96
15.3	Finish coatings	96
16	Using WEST SYSTEM Epoxy	
16.1	Epoxy safety	104
16.2	Epoxy products	105
16.3	Handling epoxy	107
16.4	Basic techniques	112
Appendix A		
	Tools	123
	Lofting foil shapes for rudders and keels	126
	Cold temperature bonding	127
	Additional reading	129
Appendix B		
	Estimating guides for WEST SYSTEM products	130
	Epoxy handling	132
Appendix C		
	Applying fiberglass overhead	133
Appendix D		
	Repairing machined holes in fiberglass laminate	135
Appendix E		
	Problem solving guide	140
	Problem solving notes	142
Index	143

1 Introduction

Over the last several decades the popular perception of fiberglass boats is that they are maintenance free and far more durable than the wooden boats that preceded them. While fiberglass boats do, on average, require less maintenance, they are not without problems. In addition to the usual damage from collisions, groundings and the forces of nature, fiberglass boats also suffer from many of the same age related problems of fatigue and moisture that have long been associated with older traditionally built wooden boats.

This manual provides repair and maintenance solutions to many of the problems that afflict fiberglass boats.

1.1 Typical fiberglass boat construction

A fiberglass boat is a composite structure, made of many layers of various reinforcing fabrics and core materials, bonded together with plastic resins. You could also look at it as a plastic resin shell reinforced with various fibers, or Fiber Reinforced Plastic (FRP). Most loads in the structure are carried by the fibers in the laminate. Resin and core materials support the fibers in positions to effectively carry and spread the loads. Generally, the higher the proportion of fiber to resin in a laminate, the greater its strength and stiffness.

The continuity of these resin/fiber skins is critical to the integrity of the structure. It is often necessary to cut through the skin while carrying out repairs, even though the skin itself may not be damaged. Keep in mind that one objective will always be to rebuild for skin continuity to return the load carrying ability of the fibers in the laminate to original or greater strength.

1.1.1 Fiberglass resins

The vast majority of fiberglass boats in use today are built with polyester resin. Modern unsaturated polyesters used in boat construction are made up of three basic components: glycol, organic acid and reactive diluents (usually styrene). If you were to look at uncured polyester resin at a molecular level, you would see what appear to be thousands of chains made up of alternating glycol and acid units. These chains are polyester pre-polymers. Adding a peroxide catalyst, typically MEKP, to the polyester resin mixture initiates a cross-linking reaction, that causes the styrene to create bridges, linking adjacent pre-polymer chains together. As the mixture cures, more and more bridges are established, and the free-flowing glycol/acid chains begin to gel, becoming a solid mass. Eventually, enough bridges are built to form a rigid, three-dimensional matrix. The mixture has become a thermoset plastic solid, used in this case, to hold bundles of fibers together in the shape of a boat.

1.1.2 Fibers

Fibers used in production fiberglass boats take the form of various types of fabrics, including mat (chopped-strand mat), woven cloth and roving, and uni-directional, bi-axial and tri-axial cloth. Each fabric type offers different properties and they are often used in combination to provide specific strength or stiffness properties in different parts of a laminate. Fabric selection may also be based on handling characteristics and cost. Most fabrics are woven or stitched together bundles of individual continuous pultruded fibers of various synthetic plastics. The least expensive and most common fiber used in production boats is E-glass. It is widely available and used extensively for repair. Fibers may also be made of more exotic and expensive materials like aramid or graphite. These fibers offer much higher strengths as well as higher costs and are used primarily in one-off, high-performance boats where saving weight is worth the higher cost. Stitched fabrics represent a major advancement

2 Introduction

in composite technology, by allowing higher fiber-to-resin ratios and stiffer laminates than woven fabrics of equal weight.

1.1.3 Cores

Cores are used in laminates to increase stiffness of a panel without adding a proportional increase in weight. Doubling a panel's thickness can result in a panel that is eight times stiffer. By laminating a lightweight core between two fiber/resin skins a lot of stiffness can be gained with a minimum amount of added weight. The skins still take all of the tensile and compressive loads caused by bending the panel but the "I" beam effect produced by the addition of the core allows the panel to withstand much greater bending loads. End-grained balsa is the most widely used core material in production boats. It offers low cost and good impact resistance and compressive strength to resist the collapsing of skins under load. PVC foam cores are available with a variety of characteristics. They are more expensive than balsa, but more resistant to moisture damage. Honeycomb core is an open corrugated pattern of paper or other thin material on edge. Honeycomb is often used in prefabricated panels for bulkheads and other interior components.

1.1.4 Construction methods

Generally, production fiberglass boat hulls are built in a female mold. A release agent is first applied to the surface of the mold, over which the gelcoat material is applied. Gelcoat is usually a pigmented, unsaturated polyester resin and may be anywhere from 12 to 22 mils thick. It is designed to act as a moisture barrier for the underlying laminate, as well as to provide a smooth, glossy, cosmetic finish. Subsequent layers of fabric are saturated with resin and laid up over the gelcoat. There are as many lay-up schedules as there are boats. A typical hull section might consist of the layer of gelcoat, several alternating layers of mat and woven roving, and in many cases a core material such as end grain balsa or foam, followed by several more alternating layers of saturated mat and woven roving (Figures 1-1 and 1-2). Hull thickness may vary from boat to boat. Older boats were often laid up with a solid glass laminate thickness of 1 1/2" (3.8 cm) to as much as 5" (12.7 cm) in the keel areas of the more heavily-built boats. Today, however, the trend is toward thinner, lighter laminates, making the structural integrity of each of the laminate components all the more critical.

Standard lay-up relies on gravity to hold all of the resin saturated material in place until cured. The technique of vacuum bag laminating has advanced composite construction by allowing the builder to compress the entire wet-out laminate evenly in the mold, and more accurately control the resin content and the strength-to-weight ratio of the laminate.

Although it's not often associated with fiberglass boats, wood is used extensively in fiberglass boat construction for primary and secondary structural members like bulkheads, frames and stringers, core material, blocking and trim. Stringers, bulkheads and other

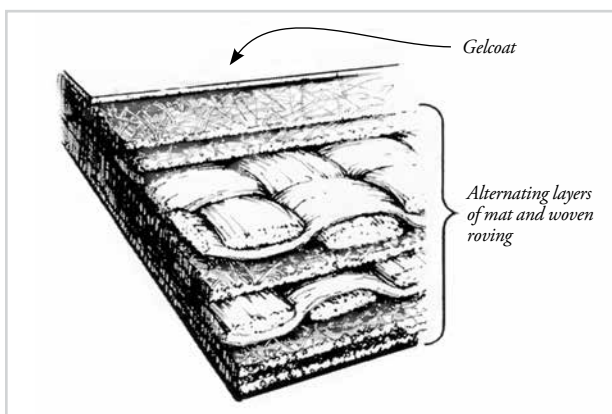

Figure 1-1 Typical solid (single skin) fiberglass laminate. Various reinforcing fabrics are bonded together with polyester resin.

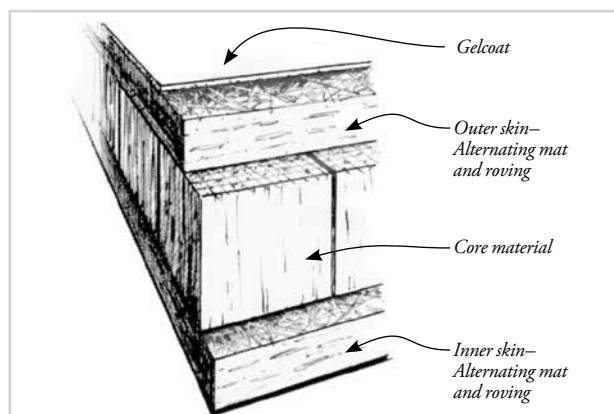

Figure 1-2 A typical cored laminate consists of end-grained balsa or other core material sandwiched between two resin/fiber skins.

interior fixtures are bonded in after the shell is laid up. Many fiberglass boat repairs involve wood and the problems associated with using polyester resins to bond to wood.

Terminology used to describe the structure of fiberglass boats is not always the same terminology used to describe wooden boats. Where fiberglass boat components serve the same functions as wooden boat components, their names are often the same. However, materials, and manufacturing methods vary from small boat to large boat, from power to sail and from manufacturer to manufacturer. Here is a general guide to the fiberglass boat terminology used in this manual (Figure 1-3).

1.1.5 Hydrolysis and gelcoat blisters

The repair procedures in this manual address problems most often associated with mechanical damage—abrasion, bending, fatigue, impacts and the resulting water damage to cores or other structural components. Another type of damage common to fiberglass boats is chemical in nature. Hydrolysis (and its symptom, gelcoat blisters) is a widespread and growing problem in the fiberglass boat world.

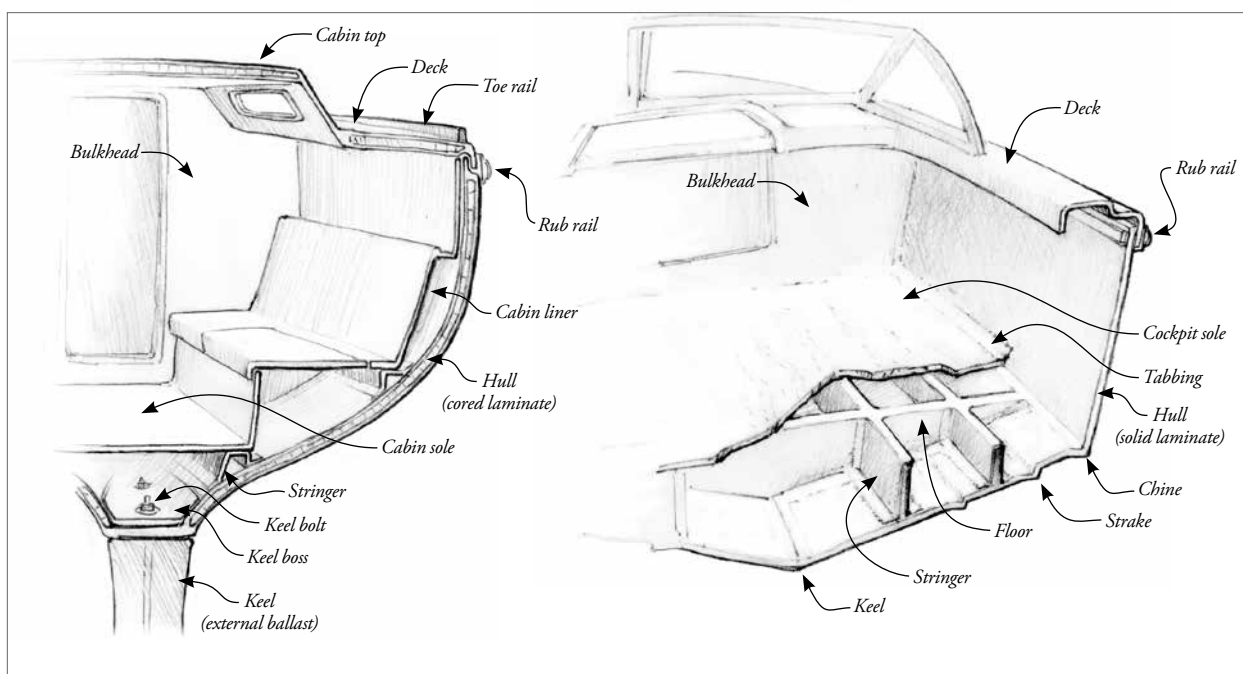

Figure 1-3 Components of typical fiberglass sail and power boats

Hydrolysis is more than a cosmetic problem. When water soluble materials in a polyester resin laminate mix with moisture that has penetrated the laminate it creates an acidic fluid. The fluid collects in cavities under the gelcoat layer to form blisters. This acidic mixture also attacks the polyester resin, severing the chemical bonds that hold the resin matrix together, as well as the resin to fiber bonds. Once hydrolysis has started in a polyester hull, the hull's strength has been compromised and the potential for serious additional hydrolysis will never go away.

If you own a fiberglass boat built with polyester resin, you should be aware that the potential for this problem is high, especially in warmer climates. Any damage due to hydrolysis should be included in an assessment of a boat's condition before repairs are made. Hydrolysis and gelcoat blisters can be treated with WEST SYSTEM Epoxy to limit further damage and in many cases restore a hull's structural integrity. For more information about hydrolysis and gelcoat blisters refer to Section 9.

1.2 WEST SYSTEM Epoxy for fiberglass repair

Unsaturated polyester resins perform fairly well during the construction of a structure when all of the layers of resin are applied and allowed to cure together. This type of bond is considered a primary bond. Problems can occur, however, when you try to bond polyester resin to a previously cured laminate as is necessary in every repair application. This type of bond is secondary or post-bonding.

To effectively repair damage typical of fiberglass boats, the repair material must be a superior structural adhesive, capable of bonding not only to polyester resin, but also to glass fiber, wood, metal and other materials.

There are several important reasons to use WEST SYSTEM Epoxy rather than a polyester resin or other material for fiberglass boat repair. Polyester resin can shrink from 5% to 8%, creating stress concentrations at the repair joint whereas epoxy doesn't shrink. In addition, epoxy is more effective as a moisture barrier and it forms a superior mechanical bond with the cured polyester and other materials in secondary bonding. Since epoxy is more durable than polyester, the epoxy repair actually may be stronger than the original structure. When you consider ease and practicality of application, availability, safety and access to technical assistance, WEST SYSTEM Epoxy is an excellent choice for fiberglass boat repair.

1.2.1 Using this manual

Study and become familiar with all of the steps in a procedure before beginning a repair. The procedures described in this manual assume a working knowledge of WEST SYSTEM products and the basic techniques of epoxy use. If you are unfamiliar with or have any questions about the application and handling techniques of WEST SYSTEM Epoxy products, read Section 16—*Using WEST SYSTEM Epoxy* thoroughly before proceeding with repairs. The WEST SYSTEM *User Manual & Product Guide* also provides basic epoxy handling information as well as complete current product descriptions and selection and coverage information. It is a free publication available through WEST SYSTEM dealers and/or can be downloaded at westsystem.com.

Some fiberglass repair procedures can be hazardous. Always wear appropriate eye protection, skin protection and a dust mask when cutting or grinding fiberglass. Follow safety guidelines when handling epoxy (Section 16.1).

If you have additional questions after reading the Using WEST SYSTEM Epoxy section, contact the WEST SYSTEM technical staff:

WEST SYSTEM
P.O. Box 665
Bay City, MI 48707
866-937-8797 (8:00 AM-5:00 PM EST)
technical@gougeon.com
westsystem.com

2 Repairing Minor Cracks and Holes

Most of the repair jobs found on fiberglass boats are cosmetic in nature. Cracking or crazing of the gelcoat and scrapes and dings account for much of the repair work being done in boat shops. Permanent repairs to these types of damage can be made with WEST SYSTEM Epoxy. When properly applied, an epoxy repair affords an extremely durable, water-resistant repair that offers an excellent base for various finishes. This section addresses the cosmetic repair of minor surface damage and cracking, and panel reinforcement to reduce the cause of cracking.

2.0.1 Assessing damage

It's easy to account for the scrapes, dings and cracks that result from impacts, but the causes of flex cracking or crazing may not be as obvious. Most cracks or crazing that appear gradually and get worse over time are the result of flexing and are most often found in areas of solid laminate. They often appear near a bulkhead, deck to cabin curve, or window. In addition to the cosmetic surface repair, a thorough repair will often require structural repair or reinforcing to reduce the flexing. The longer a laminate is allowed to flex, or the greater the impact, the deeper the cracks. The deeper a crack extends into the laminate, the more the panel's strength is reduced. The first step in the repair is to prepare the damaged area and assess the degree of damage:

1. Examine the pattern and location of cracks to determine their cause (Figure 2-1). If the pattern or location indicates flexing, examine the interior side of the panel to determine the best location for additional reinforcing. If the cracks are a result of impact, examine

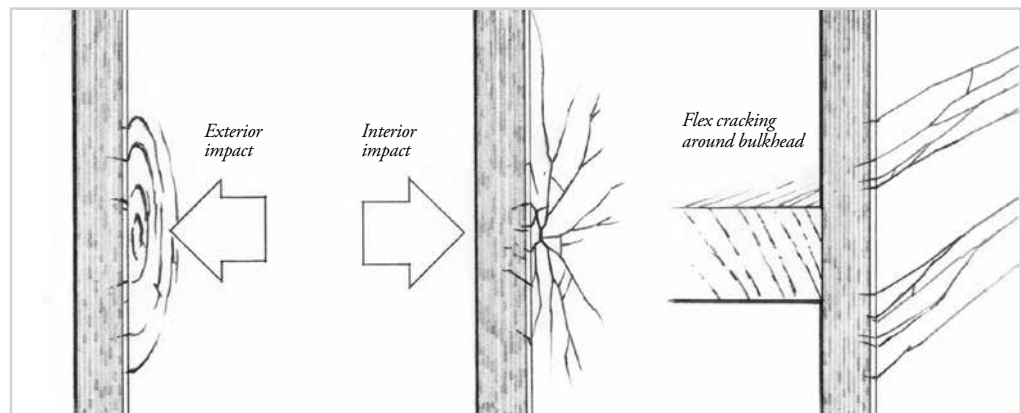

Figure 2-1 Typical types of cracks from impact or flexing. The pattern of cracking may help to determine its cause.

the interior side of the panel to determine whether damage extends through the entire laminate.

2. Remove any surface contaminants such as wax, oil or mold release. Wipe an area at least twice as large as the damaged area with a wax and silicone remover (Dupont Prep-Sol® #3919S), acetone or other appropriate solvent. Dry the area with paper towels before the solvent evaporates.
3. Open the cracks for repair. Use a sharpened “V” shaped tool to scrape down to the bottom of the cracks (Figure 2-2). A puncture-type can opener with the tip sharpened to about 90° works well. Beveling the sides of the crack provides more bonding area for the repair. It may be more effective to grind out an entire area of many, closely spaced or

6 Repairing Minor Cracks and Holes

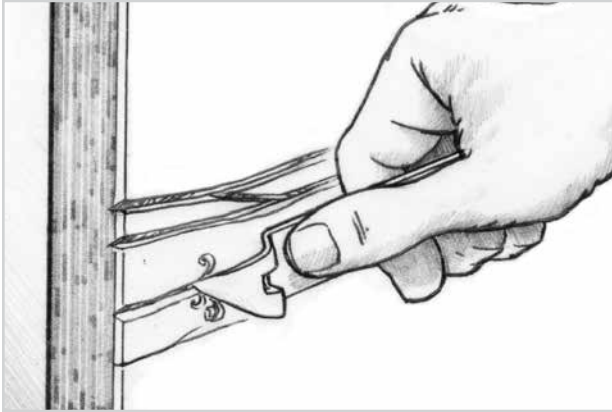

Figure 2-2 Open shallow and minor cracks with a “V”-shaped scraper, such as a sharpened can opener.



Figure 2-3 Grind out an area of many closely spaced or deep cracks with a disk grinder.

deep cracks (Figure 2-3). Scrape or grind as deep as necessary to reach solid, undamaged material. The depth of the crack will determine which course of repair to follow:

- a. Shallow cracks or scrapes that affect only the gelcoat layer may be repaired with the gelcoat repair technique described in Section 15.3.3. If necessary, reinforce the laminate to reduce flexing as described in Section 3.6. Some small cracks or chips can be filled with a gelcoat touch-up kit.
- b. Minor cracks or scrapes that run through the gelcoat into the first chopped strand mat layers of the laminate (Figure 1-1) should be repaired with epoxy using the procedures described below (Section 2.1). Finish with the gelcoat repair technique described later in Section 15.3.2. If necessary, reinforce the laminate to reduce flexing as described in Section 3.6.
- c. Deep cracks extending into woven fabric of the laminate require a structural repair before beginning the cosmetic gelcoat repair. If the crack extends into or through the woven fabric of the skin, follow the procedures in Section 4. If a core has delaminated or is damaged from moisture penetration or impact, follow the appropriate procedure in Section 5.

2.1 Minor crack and abrasion repair

Minor cracks and scrapes that extend to the chopped strand mat layers of laminate may be repaired with WEST SYSTEM Epoxy.

Scraped out damage

If cracks were exposed with a “V” shaped scraper, complete the repair as follows after preparing the damaged area as described above:

1. Feather the edges with the scraper or with 100-grit sandpaper and brush the surface free of dust and loose material.
2. Fill the cracks with Six10® Epoxy Adhesive dispensed through the static mixer. Or, wet out the cracks with a 105 Resin/hardener mixture. Then fill the cracks with a 105 Resin/hardener mixture thickened to the consistency of peanut butter with 406 Colloidal Silica Filler. Apply the mixture with the flat end of a mixing stick or a plastic spreader.
3. Trowel the epoxy flush with the surface and remove excess epoxy before it begins to cure. Allow the epoxy to cure thoroughly.
4. Sand the area smooth. Use 100-grit paper to remove any bumps or ridges. Finish by wet-sanding with 220-grit.
5. Finish the area with gelcoat or paint following the procedure in Section 15.3. Reinforce the laminate as necessary to reduce flexing, following the procedure in Section 3.6.

Ground out damage

If the damage is the result of a scrape or gouge, or cracks were exposed with a grinder, complete the repair as follows:

1. Grind a shallow bevel around the damaged area. Remove any dust or loose material.
2. Fill the cracks with Six10 thickened Epoxy Adhesive dispensed through the static mixer. Or, wet out the cracks with a 105 Resin/hardener mixture. Then fill the cracks with a 105 Resin/hardener mixture thickened to the consistency of peanut butter with 406 Colloidal Silica Filler. Apply the mixture with the flat end of a mixing stick or a plastic spreader.
3. Shape the thickened epoxy to match the surface contour using a plastic spreader. Leave the mixture slightly higher than the surrounding area and remove any excess before it begins to cure. Allow the epoxy to cure thoroughly.
4. Sand the area to blend with the surrounding contour. Use 50-grit paper to remove any bumps or ridges and finish with 80-grit paper when you are close to the final shape.
5. Fill any remaining voids (if necessary), repeating Steps 3 and 4.
6. Wet sand the area with 180-grit paper to prepare for the final finish.
7. Finish the area with paint or the gelcoat finishing procedure (Section 15), beginning with step 4. Reinforce the laminate as necessary to reduce flexing, following the procedure in Sections 3.5.1 and 3.6.

3 Repairing Stringers and Floors

3.1 Reinforcing to improve panel stiffness

Fixing damaged or delaminated stringers is one of the most common repairs associated with fiberglass boats. The usual causes of stringer failure are disintegration of the stringer core material, impact damage from slamming and grounding, and fatigue from normal use. Although each repair situation has its own unique problems, the following techniques are fundamental to stringer repair. These guidelines will help you repair almost any damaged stringer.

3.1.1 Typical stringer construction

Stringers are support members bonded into boat hulls, usually oriented parallel to the long axis of a boat hull. Floors are support members oriented perpendicular to the long axis of the hull. They are there for a variety of reasons. They stiffen unsupported flatter hull panels in the same way that ribs or beams are used to provide the structural framework for wooden boats. They support cockpit and cabin soles, and they distribute high load concentrations from engines and other mechanical systems. Often they perform several of these functions simultaneously.

In fiberglass boats, you will find that most often, stringers (and floors) are composed of a core material overlaid with a fiberglass skin. The skin usually extends a few inches on either side of the stringer. This skin extension, or tabbing, ties the stringer to the hull or bulkheads and spreads the load of the stringer over a larger area. Tabbing may be a simple piece of glass tape across the stringer/hull joint, or an integral structural part of the stringer. Some cores are structural, or active, and some are inactive, used primarily to provide a form for a structural fiberglass skin.

Active core stringers, with cores of solid wood or plywood, rely on the structural properties of the wood core itself to provide stiffness. Generally, the more dense the core material (like wood or plywood) the more of the load it is expected to carry. The fiberglass skin covering an active core is primarily used to protect the wood and to attach it to the hull. It is generally thinner than the skin on inactive core. When you replace structural cores, you have to use proper scarf bevels or other proper means of piecing the new core into the old. Occasionally, you will find a material that appears to be plywood, but all the veneers are oriented in the same direction. You cannot repair this unidirectional material with plywood. Plywood has half the grain running at right angles to the face veneer. It does not have the same strength

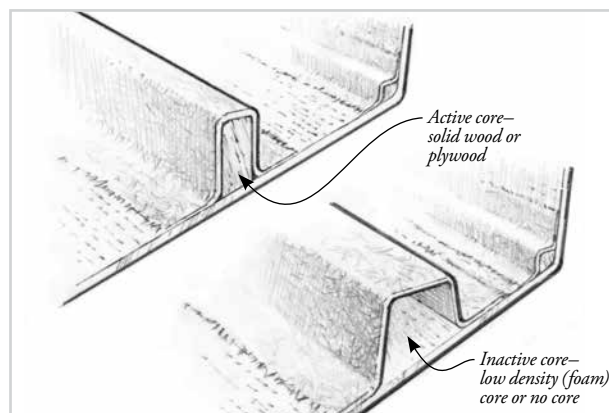

Figure 3-1 Some cores are structural, or active, and some are inactive, used primarily to provide a form for a structural fiberglass skin.

as unidirectional material. A common example of unidirectional plywood material is called laminated veneer lumber (LVL).

Inactive core stringers rely on the geometry of the fiberglass skins to provide stiffness. The nonstructural cores are primarily forms to give a vertical profile to layers of fiberglass. Inactive cores are made of low-density foam, cardboard tube, or in the case of molded stringers, no core at all. Molded stringers are pre-built in a mold and tabbed in after the hull is built. This type of stringer has no core material, just fairly heavy fiberglass skins to stiffen the hull.

3.1.2 Assessing damaged stringers

Before you start any repair, it is a good idea to know what you are getting into. Looking at the suspected area of damage may be as easy as opening a hatch, but don't count on it. Hull liners or cabin and cockpit soles are common and usually fastened to the very stringers you are trying to fix. It is also difficult to see under engines, water tanks, and the like. You may have to cut access holes in the hull liner or cabin sole to see the area in question. Stringer damage often accompanies sole delamination—See Section 6. Fortunately, you can purchase access covers to fill the holes if there is no stringer damage to repair.

Once you have resigned yourself to cutting holes in your boat, use a mirror and flashlight and look for the following:

Impact damage—Look for obvious fractures in the stringer. Also look for delamination of tabbing and core away from the impact point. Inspect the tabbing where the stringer attaches to a hull bulkhead or transom.

Rot damage—Wood cores rot from water leaking around fasteners and from water collecting where the fiberglass skin has delaminated. You can often tap the suspected area of stringer with a small hammer. The impact of the hammer has a definite “dead” sound where the core is not firmly attached to the fiberglass.

3.2 Repairing local core damage

For small areas of rot, you may be able to simply dry the stringer and inject epoxy into the rotted area. While this is a common method of wood stringer repair, it is not nearly as effective as replacing the damaged area with wood. Without removing the skin from the wood, it is often difficult to determine the extent of the rot and how wet the core is. Also, the degree of penetration of the injected epoxy cannot be accurately determined so you do not know how good your repair is. If however, you choose to use this method, we recommend the following procedure:

1. Drill a pattern of $\frac{3}{16}$ " (4.7 mm) diameter holes over the rotted area. Space the holes 1" (25 mm) or less from center to center in all directions. Drill each hole deep enough to pass through the rot, just into solid wood.
2. Dry the core thoroughly. If necessary, use heat guns or fans to accelerate drying.

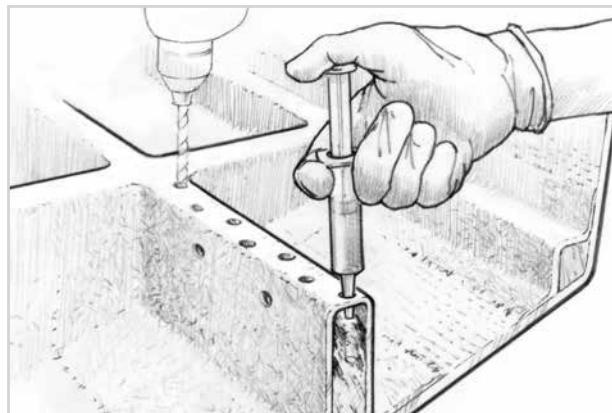

Figure 3-2 Inject or pour resin/hardener mixture into the holes when the core is dry and while the core is warm.

3. Inject or pour resin/hardener mixture into the holes while the core is warm (Figure 3-2). Epoxy, warmed by the core, will become thinner and penetrate more deeply into the exposed end grain. 206 Slow Hardener should penetrate more deeply than 205 Fast Hardener before it begins to gel.
4. Continue to inject epoxy into the holes until the core can no longer absorb epoxy and the voids under the skin are filled.
5. Fill remaining surface voids with thickened epoxy after the injected epoxy reaches its initial cure, if necessary. Use an epoxy/low-density filler mixture for cosmetic fairing of the surface.
6. Apply a layer or two of fiberglass tape or cloth over the stringer to restore stiffness if the damage and hole drilling is extensive.

3.3 Stringer repair guidelines

For more serious repairs that involve removing and replacing stringer material, try to duplicate the original construction. Unless the damage is directly attributable to an undersized stringer, assume that the stringers were structurally adequate and properly located when the boat was originally built. Making a repair that is significantly stronger than the original design can cause hard spots that may distort or crack the hull shell. A repair that is lighter than the original may fail prematurely.

When removing and replacing stringer material, observe the following guidelines:

Duplicate the shape and dimensions of the original stringer. Stringer height is critical to stringer stiffness. In addition, where the stringer is supporting a cockpit sole, cabin sole or engine, the height of the repaired or replaced stringer must be the same as the original. If not, you will have a great deal of difficulty reinstalling the equipment.

Duplicate the original core material or find an equivalent material. Use wood where wood was used, plywood for plywood, foam for foam, etc. Attempt to duplicate the species of wood used in the stringer as well as the dimensions of the wood. You can use a more cavalier approach to replacing low-density core materials than you can for active cores.

Measure the thickness of the fiberglass skin and duplicate it. On stringers with an inactive core or molded stringers (with no core), watch for variations in the skin thickness. Occasionally, the top skin of the stringer is thicker than the side skins. This “cap” can significantly increase the strength and stiffness of the stringer. If the extra thickness is present, try to duplicate it.

Locate new stringers as close as possible to their original position. This is especially true of engine stringers or stringers that support other equipment. Increasing stringer spacing can also reduce panel stiffness.

Support the hull. If major stringer replacement is necessary, be sure to support the hull well so the original shape is maintained. Stringers that are removed or have broken away from the hull may allow parts of the hull to sag.

3.4 Replacing active core sections

Often damage to the core of a stringer is limited to a small section, or the stringer may be too difficult to remove. You may be able to replace only the damaged portion, restoring the strength of the stringer while leaving it in position in the boat.

Because the wood in active-cored stringers is structural, any repairs you make to it have to be joined with a proper scarf. If you are replacing a section of plywood stringer, use a minimum of an 8-to-1 scarf bevel. For a $\frac{3}{4}$ " (19 mm)-thick piece of plywood this equates to a 6" (15.24 cm)-long bevel. When repairing hardwood or highly loaded core areas, use a longer (12-to-1) scarf angle. When cutting scarfs, keep in mind, the longer the scarf angle, the greater the joint surface area, the stronger the joint. All joints in fiberglass skins should have a minimum 12-to-1 bevel or overlap.

Forming the scarf bevel on the new piece of wood is fairly easy. You can use typical cutting tools with the piece of wood supported on a work bench. Cutting the matching bevel on the wood that remains in the stringer is not as easy. Use chisels, disc grinders, hand planes, hand saws, and any other useful tool available to you to cut wood and fiberglass. The surface of the bevel does not have to be perfect.

1. Cut out the damaged section of the existing stringer. Remove as much skin as necessary to remove all of the damaged core. Trim the exposed core ends to a minimum 8-to-1 scarf angle (Figure 3-3). The scarf may run vertically or horizontally.
2. Prepare for the skin replacement. Prepare both sides of the joint to achieve a good bond
3. Trim a new piece of core material to fit the size and shape of the void in the existing core. Use the same species of wood as the existing core. Cut a matching scarf angle on each end of the new core section. Dry fit and trim the new piece and existing core ends as necessary for a good fit.

Figure 3-3 Trim a new piece of core material to fit the size and shape of the void in the existing core. The scarf may run vertically or horizontally.

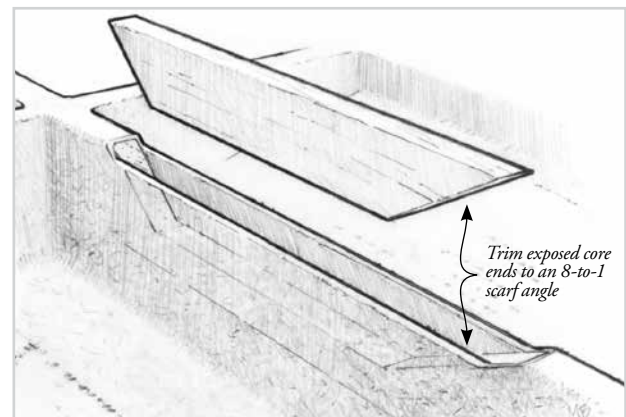

4. Prepare the surfaces for bonding. All surfaces should be clean, dry and sanded.
5. Apply a liberal amount of Six10 Epoxy Adhesive, dispensed through the static mixer, to the contact areas. Use enough thickened epoxy to bridge all gaps between the two surfaces. Or, wet out all contact surfaces with a 105 Resin/hardener mixture. Then apply a liberal coat of 105 Resin/hardener mixture, thickened to the consistency of mayonnaise with 406 Colloidal Silica Filler, to one side of each contact area. Using the flat end of a mixing stick or a plastic spreader, apply enough thickened epoxy to bridge all gaps between the two surfaces.
6. Push the new core section into position. A small amount of thickened epoxy should squeeze out around the core. Clamp the section in position. Clean up excess epoxy before it cures. Remove clamps after epoxy cures thoroughly.
7. Replace the fiberglass skin as described in Section 3.5.1.

3.5 Replacing stringers

Completely replacing a damaged stringer is often easier than replacing a section. For example, engine stringers commonly run from the transom to a bulkhead. They may not run the entire length of the boat. Complete replacement of the damaged stringer may be much easier than attempting to replace a section of it. Stringers can also be added to under-engineered panels to improve stiffness. Replace stringers as follows:

1. Mark the location of the stringer before you remove it. It is often critical that the stringer gets replaced in exactly the same position it was previously located. Locate reference marks far enough away from the repair area so they will not be disturbed when you prep the area.
2. Remove the stringer and core. Use a grinder to cut the tabbing at the core/hull joint. Do not cut into the hull laminate. Save any large pieces of core you remove if they can be

12 Repairing Stringers and Floors

used as pattern to help fit the new core. Measure the thickness of the fiberglass skin so you can duplicate it.

3. Using the same species of wood as the existing core, fit a new piece of core material to fit the size and shape of the core in the removed stringer. See Section 3.3 for various stringer core repair guidelines. Dry fit and trim the new piece for a good fit.
4. Prepare the surfaces for bonding. All surfaces should be clean, dry and sanded. Remove any traces of contamination by wiping the surface with solvent and drying with paper towels before the solvent evaporates. Use a degreaser or detergent in areas that may be contaminated with gasoline or oil residue before wiping with solvent. Use a stiff nylon bristle brush on heavily textured surfaces like roving. Abrade the bonding surfaces by sanding with 50-grit sandpaper or a Norton® RapidStrip Brush #01123 and brush the area free of dust or loose material. Use a wire brush to abrade heavily textured surfaces. The bonding surface should appear dull. Sand the bonding surfaces of hardwood or epoxy coated stringers with 50-grit sandpaper.
5. Apply a liberal amount of Six10 Epoxy Adhesive, dispensed through the static mixer, to the contact areas. Use enough thickened epoxy to bridge all gaps between the two surfaces. Or, wet out all contact surfaces with a 105 Resin/hardener mixture. Then apply a liberal coat of 105 Resin/hardener mixture, thickened to the consistency of mayonnaise with 406 filler, to one side of each contact area. Using the flat end of a mixing stick or a plastic spreader, apply enough thickened epoxy to bridge all gaps between the two surfaces.
6. Push the new stringer into position. A small amount of thickened epoxy should squeeze out around the core. Clamp the stringer in place with braces or tape as necessary.
7. Shape the squeezed out epoxy into a fillet (Figure 3-4). Apply additional thickened epoxy to the joint if necessary for a smooth 1/2" (12 mm) radius fillet. Shape and clean up excess epoxy before it cures. Remove clamps after epoxy cures thoroughly.
8. Replace the fiberglass skin as described below.

Figure 3-4 Epoxy mixture should squeeze out of the joint. Shape the squeezed out epoxy into a fillet.

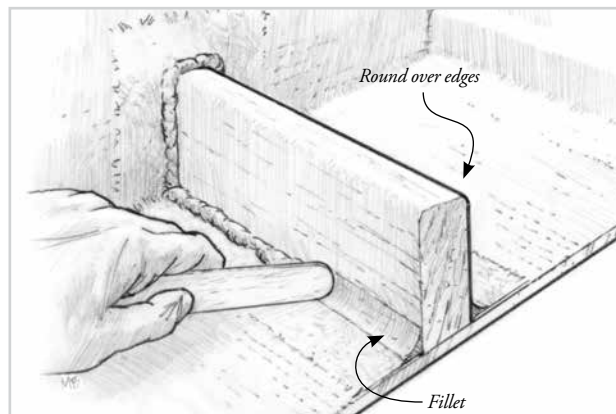

3.5.1 Applying the fiberglass skin

After repairing or replacing core material, it is necessary to replace the fiberglass skin and tab the stringer to the hull and bulkhead or floor. To duplicate the strength of the original skin, it is important to duplicate the thickness of the original skin and to properly prepare the surfaces for a good bond.

Preparing the fiberglass fabric

Measure the thickness of the skin on the original stringer. Keep in mind, the top skin may be thicker than the sides and the tabbing. Refer to the chart in Appendix A to determine the number of layers of a particular weight fabric necessary to achieve the thickness required.

Cut the necessary number of strips of fiberglass fabric the length of the stringer. Cut the first piece large enough to extend as far as the original tabbing from each side of the stringer. Cut each of the remaining pieces 1/2" (12 mm) narrower on each side than the previous one. When laying out the layers of fabric, do not allow the tabbing edges to end at the same place. For stress reduction, step the edges of the fabric to create a tapered edge. If you fail to do this,

all the load the stringer is carrying will be transferred to the line on the hull's surface where the tabbing ends and the hull may crack at that point. If, however, you step the tabbing edges, the load from the stringer is gradually distributed to the hull. Where stringers end at a bulkhead or the transom, wrap the glass tabbing onto them in the same manner.

WEST SYSTEM 738 Fabric is ideal for stringer repairs. It yields about 0.040" per layer in a hand lamination, so you will need fewer layers of cloth to achieve the necessary thickness for most stringers. Fewer layers of fabric translates into less labor to install it. There is however, nothing wrong with using a lighter fabric. It will require more layers per unit of laminate thickness and thus more time to install it. Structurally, there is little difference between 5 layers of 24 oz. fabric or 10 layers of 12 oz. fabric.

Preparing surfaces for bonding

Surface preparation for bonding is a critical part of any repair. The bilge of a boat can be very difficult to prepare for bonding, because it is likely to be contaminated (especially around engines) and many areas may be inaccessible.

Use a degreaser or detergent in areas that may be contaminated with gasoline or oil residue before wiping with solvent. Use a stiff brush on heavily textured surfaces like roving. Remove any traces of contamination by wiping the surface with solvent and drying with paper towels before the solvent evaporates.

Use a 50-grit grinding disc to prepare smooth surfaces. A 50-grit disc cuts quickly with little heat build-up. Use a Norton® RapidStrip Brush #01123 or a wire brush to abrade heavily textured surfaces. Brush the area free of dust or loose material. The bonding surface should appear dull.

A 12-to-1 bevel must be ground into any existing fiberglass left on a stringer. The new fiberglass will run onto this bevel attaching the new material to the original material. A 12-to-1 bevel provides adequate surface area for the transfer of loads across the repair area. For example, if the skin on the original portion of the stringer is ¼" (6 mm)-thick, the bevel needs to be 12 × ¼" or 3" (72 mm) wide.

It is difficult to lay fiberglass cloth around a sharp 90° corner. You have to round over the top edges of the cores and fillet the core/hull and core/bulkhead inside corners—a ⅜" (9.5 mm) radius for thinner fabric, ½" (12.7 mm) radius for thicker fabric.

Applying the fiberglass skin

1. Prepare fiberglass fabric and bonding surfaces as described above.
2. Wet out the entire bonding surface, including the stringer, with a resin/hardener mixture. Squeegee a thin layer of thickened epoxy over the exposed panel bonding area if the surface is heavily textured. Mix epoxy with 404 High-Density or 406 Colloidal Silica filler to the consistency of mayonnaise. The thickened epoxy will fill voids on the surface and provide better contact with the first layer of fabric.
3. Center the largest piece of fabric over the stringer and reinforcement area and wet it out with the resin/hardener mixture. Squeegee any excess epoxy from the surface, making sure the entire piece of fabric has been saturated.
4. Apply each successive piece of fabric in the same manner. Successive pieces may be applied immediately after the previous piece or any time before the previous piece becomes tack free. The fabric edges should be stepped, with the last piece extending about 1¾" (44 mm) to 2¼" (57 mm) from each side of the stringer (depending on the number of fabric layers). Allow the lay-up to reach its initial cure (Figure 3-5).
5. Apply two or three coats of epoxy to fill the weave of the cloth. To avoid sanding between coats, apply each coat before the previous coat becomes tack free. Allow the final coat to cure thoroughly.

Note: The final two or three coats may be tinted with WEST SYSTEM 501 (white), 502 (black) or 503 (gray) pigment or with 420 Aluminum Powder (gray) or 423 Graphite Powder (black). If you desire a smoother cosmetic finish, the lay-up may be faired and finished.

When your repair is complete, you will have a little additional finishing work to do. Fiberglass repairs inevitably have some sharp edges or sharp "hairs" sticking out. These make

Figure 3-5 Cut each of the remaining pieces 1" (25 mm) narrower ($\frac{1}{2}$ " each side) than the previous one. Squeegee any excess epoxy from the surface, but make sure the entire piece of fabric has been saturated.

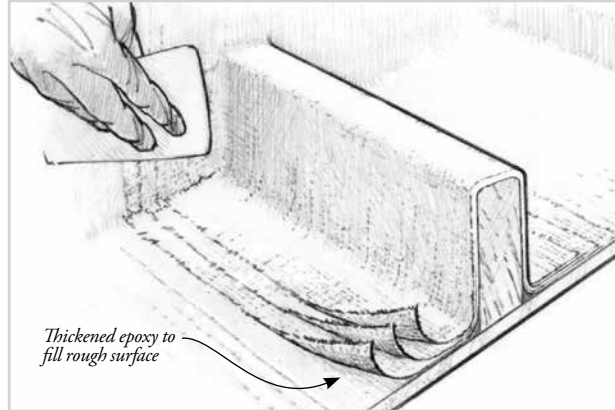

cleaning the bilge difficult, if not downright dangerous. Use 80-grit sand paper to eliminate imperfections that might cut you.

You have a couple of options for final finishing:

1—Do nothing. Since most of the work is in the bilge area, you do not need to apply a final finish. UV degradation of the epoxy will not be a problem and in many circumstances, the appearance of the repair does not matter.

2—Paint the repair. If the appearance of the repair matters, select a paint color that matches the rest of the area and paint the repair. Proper surface preparation of the repair includes washing with water and thoroughly sanding the epoxy surface (See Section 15.2—*Final surface preparation*). Apply a paint primer or apply the topcoat directly to the prepared epoxy.

As always, when you're installing any hardware, use epoxy to seal all holes you drill. If you neglect this step, you will likely have another repair job in a few years when the core material rots.

3.6 Reinforcing to improve panel stiffness

Small cracks and flaws in panels can be a result of high-stress concentrations and flexing within a panel. A common example of this problem is hairline cracking around the perimeter of a foredeck, usually the result of the deck's flexing under load. Similarly, a lightly-built hull may experience considerable flexing as it pounds through waves, resulting in cracks around bulkheads. In the flatter bow areas, panel flexing or "oil-canning" often results in gelcoat crazing. Such deflections can be controlled by reinforcing these panels using WEST SYSTEM Epoxy. Panels can be reinforced by adding fiberglass, core material and fiberglass or stringers, with or without fiberglass. Some of these reinforcing methods can be further improved with the use of graphite fibers.

3.6.1 Reinforcing with fabric

Perhaps one of the simplest methods of reinforcing a large area, particularly the hull, is to laminate layers of fiberglass fabric to the interior surface of the hull or deck to increase the thickness of the laminate. Bonding layers of fiberglass fabric to a panel is covered in Section 16.4.5—Applying woven cloth & tape. Multiple layers of fabric may be applied one after the other or before the previous layer has become tack free. Step each layer back from the previous layer (progressively smaller layers) to avoid stress concentrations at the edge of the stiffer area.

3.6.2 Reinforcing with fabric and core material

As noted in the introduction, doubling the thickness of a laminate will increase its stiffness by eight times. Bonding a core material between the fiberglass fabric and the interior of a panel is a good way to increase stiffness with a minimum amount of added weight. Either end-grained balsa or a rigid, closed-cell foam are good choices for a core material. This method of reinforcement is useful over large areas with good access to the interior side of the panel.

Stiffen a flexible panel by bonding core material and fiberglass fabric to the inner side of the panel. Bond the core in place as follows:

1. Prepare the surface for bonding. Remove any traces of contamination by wiping the surface with solvent and drying with paper towels before the solvent evaporates. Use a degreaser or detergent in areas that may be contaminated with gasoline or oil residue before wiping with solvent. Use a stiff nylon bristle brush on heavily textured surfaces like roving.
2. Abrade the bonding surface by sanding with 50-grit sandpaper or use a Norton® RapidStrip Brush #01123 mounted in a drill. Brush the area free of dust or loose material. Use a wire brush to abrade heavily textured surfaces. The bonding surface should appear dull.
3. Prepare the core material and fabric. Cut the core material to size. Round the corners and bevel the edges of the core material to reduce stress concentrations. Cut four or five pieces of fiberglass cloth, each piece an inch or two shorter on each side than the one before. The smallest piece of fabric should overlap the core material by 2" (5 cm) on each side (Figure 3-6). Bond the fiberglass fabric to the core and panel as follows:
4. Wet out the contact surfaces with a 105 Resin/hardener mixture. Then apply a liberal coat of 105 Resin/hardener mixture, thickened to the consistency of mayonnaise with 406 filler, to one contact surface. Apply enough thickened epoxy in an even layer to bridge all gaps between the two surfaces. This alternative is recommended for larger repairs. Or, especially with smaller core areas, apply a liberal amount of Six10® Epoxy Adhesive, dispensed through the static mixer, to the core contact area. Spread the adhesive to a layer thick enough to bridge all gaps between the two surfaces.
5. Press the core material firmly in position. A small amount of thickened epoxy should squeeze from the joint around the piece. Clamp the piece (or pieces) with plastic covered weights or braces, if necessary, to hold it in place. Shape the excess thickened epoxy into a fillet at the core/panel joint and remove excess epoxy before it begins to gel. Allow the epoxy to cure before removing clamping.

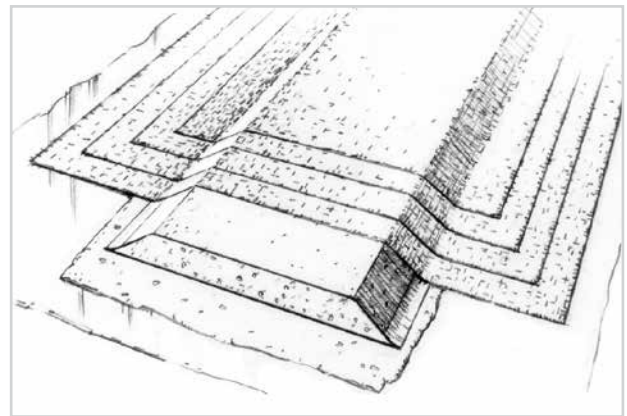

Figure 3-6 *End-grained balsa or high-density foam core material is useful for reinforcing large panel areas.*

6. Wet out the bonding surface of the core material and panel with a mixture of resin/hardener. Squeegee a thin layer of WEST SYSTEM 105 Resin based epoxy thickened with 404 or 406 filler to the consistency of mayonnaise over the core and exposed panel bonding area if the surface is heavily textured. (Or, use Six10 Epoxy Adhesive, especially for smaller areas.) The thickened epoxy will fill voids on the surface and provide better contact with the first layer of cloth.
7. Center the largest piece of fiberglass fabric over the reinforcement area and wet it out with epoxy. You may find it helpful to hold the fabric in place with pieces of masking tape. Squeegee any excess epoxy from the surface, but make sure the entire piece of cloth has been saturated.
8. Apply each successive piece of cloth in the same manner. Each piece may be applied immediately after the previous piece is applied or any time as long as the previous piece feels tacky. The final piece should extend beyond the core at least 2" (50 mm) on each side.

9. Allow the lay-up to reach its initial cure. Apply two or three coats of epoxy before the lay-up reaches its final cure. Apply each coat while the previous piece still feels tacky. Allow the final coat to cure thoroughly.

Note: The final two or three coats may be tinted with WEST SYSTEM 501 (white), 502 (black) or 503 (gray) pigment or with 420 Aluminum Powder (gray) or 423 Graphite Powder (black).

If you desire a smoother cosmetic finish, the lay-up may be faired and finished. Follow the fairing instructions in Section 14 and Section 16.4.4 and the finishing instructions in Section 15.

Note: Vacuum bagging is an ideal clamping method for large bonding areas such as this.

3.6.3 Reinforcing with stringers

One of the advantages of using wood for stringers is that most of the stiffness comes from the wood itself, so you need to rely less on additional fiberglass fabric for strength.

Solid wood and plywood

Plywood or solid wood stringers can be cut to shape with a band or table saw. The end of each stringer should either butt into a bulkhead or a floor, or should be tapered to the surface with at least a 8-to-1 slope. Failure to do this will result in hard spots, causing stress fractures or cracking.

The stringer cross sections are generally rectangular or square, although a trapezoid is a good selection if you are using solid wood. The trapezoid has a wide base for load distribution, narrowing at the top to offer less weight. If fiberglass fabric is to be applied over the stringer, the trapezoid shape allows easier fiberglass fabric application (Figure 3-7). The upper edges should be rounded to eliminate sharp corners.

Install new stringers and apply fiberglass fabric over the stringers as described in Section 3.5.

Laminated wooden stringers

Laminated stringers have structural advantages over cut stringers, especially in curved areas. Laminated stringers are made of multiple thin layers of wood and can duplicate the shape of the inner side of the panel. More of the wood grain in the stringer follows the shape of the panel, making laminated frames stronger. The new frame can be laminated in a simple jig made from a pattern or, in some cases, directly in place on the back of the panel.

When preparing wood for laminated stringers—

- Use wood strips thin enough to bend easily into the shape of the panel. Be sure all of the strips collectively can bend to shape. Thick strips want to relax or springback.
- For a curved frame with greater strength and less springback, use more, thinner strips for a given stringer thickness.
- Use full-length strips. Make the strips longer than the finished stringer to allow for trimming.
- Select wood strips that are seasoned. Ideal moisture content is 6% to 14%.

A laminating jig will allow you to laminate a new frame in the controlled environment of your shop. Use cardboard or other convenient material to pattern the inside face of the

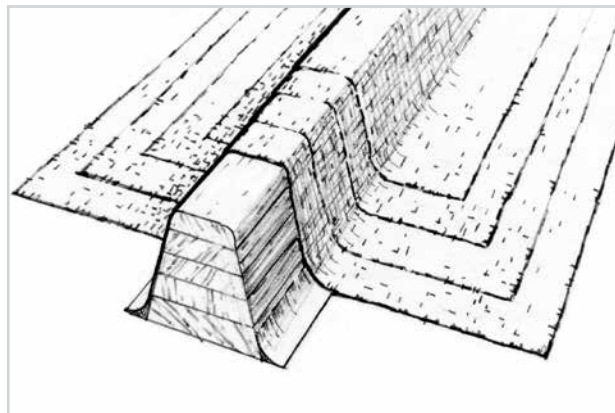

Figure 3-7 Laminated or solid wooden stringers provide effective panel reinforcement with or without the addition of fiberglass fabric.

panel at the stringer locations. Transfer the pattern line to a laminating jig of one the types illustrated (Figure 3-8). Laminate frames in a jig as follows:

1. Prepare the jig and the strips as suggested. Go through a dry run to be sure the strips bend enough and that your jig and clamps can handle the bending of all of the strips. Cover the jig with plastic to prevent the frame from bonding to the jig.
2. Apply Six10® Epoxy Adhesive, dispensed through the static mixer, to all contact surfaces. Apply enough adhesive, spread to an even layer with a plastic spreader, to bridge all gaps between the two surfaces. Or, wet out the contact surfaces with a 105 Resin/hardener mixture. Then apply a liberal coat of 105 Resin/hardener mixture, thickened to the consistency of mayonnaise with 406 filler, to one side of each adjoining contact surface. Apply enough thickened epoxy in an even layer to bridge all gaps between the two surfaces.
3. Stack the coated strips in the jig. Clamp the strips in place using clamps (Figures 3-8 and 3-9), wedges, staples or small nails. Apply enough pressure to squeeze a small amount of epoxy from each joint. Clean up excess epoxy before it begins to cure. Leave clamps in place until the epoxy cures.
4. Remove the stringer from the jig after the epoxy has thoroughly cured. Be sure to allow extra cure time if the temperature is cool, especially if you expect a lot of springback. Trim laminated stringers to final shape.

When gluing oak and oily woods, sand with 60-80 grit paper and wipe with isopropyl alcohol with white paper towels and glue with G/flex 650 (liquid) or G/flex 655 (thickened) epoxy.

Install new stringers as described in Section 3.5. Apply fiberglass fabric over the stringers as described in Section 3.6. If you have added stringers to an exposed interior area, you may not want to or need to apply fiberglass over them. Wood stringers, especially the laminated type, can enhance the appearance of your boat's interior. They provide a nice touch when varnished, while they serve their primary function of reinforcement. If you choose to coat the stringers, sand the stringers and fillets to prepare for bonding. Apply two or three coats of epoxy to seal the stringer. Allow the final coat to cure thoroughly.

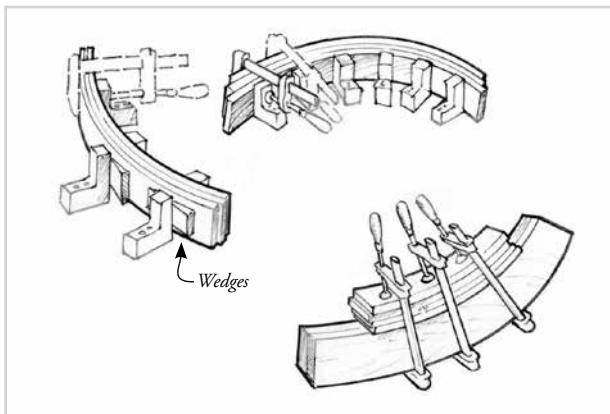

Figure 3-8 Transfer the desired stringer profile to a laminating jig.

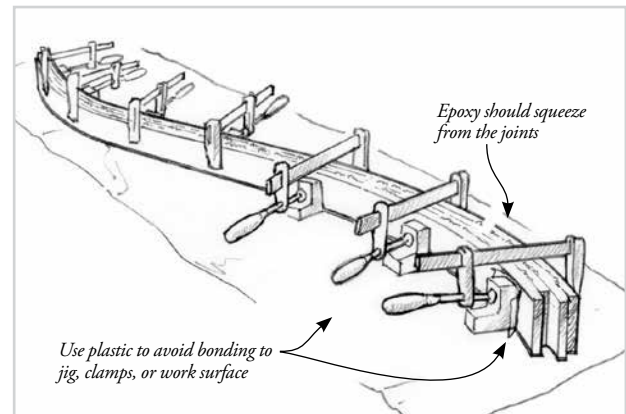

Figure 3-9 Clamp the appropriate number of coated strips into the jig. Trim the stringer to size after the epoxy is fully

Half-round and foam cores

Half-round or foam reinforcements with a fiberglass skin are a simple way of strengthening panels. With this method, the core material primarily serves as a form and the laminated fiberglass fabric provides the stiffening strength.

For light-duty applications, an economical core material for this method of reinforcement is a cardboard or paper tube cut in half lengthwise. Pieces can be placed end to end to reinforce larger areas. The tube should be heavy enough to hold its shape during the lay-up and cure of the fabric laminate. Low-density foam also makes an economical core material. Cut the foam on a table or band saw to a trapezoid shaped cross section. The trapezoidal cross section is more effective than the half-round cross section because it places more reinforcing fibers on the top of the stringer, away from the stringer's neutral

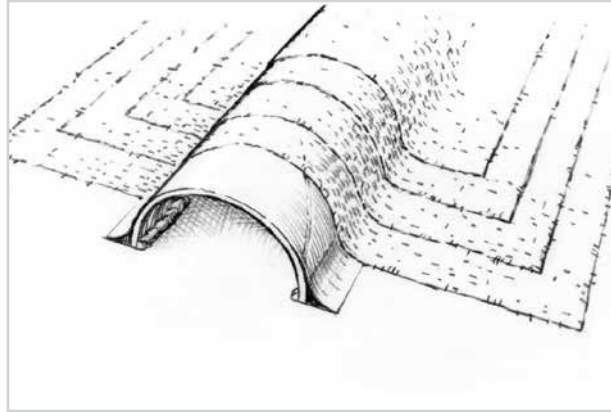

Figure 3-10 *The half-round material serves as a form for the laminated fiberglass fabric, that provides the stiffness.*

axis. Cut a 8-to-1 bevel on ends that fall in the middle of a panel. Sand a $\frac{3}{8}$ " (9 mm) radius on the top edges.

To bond half-round tubes—Apply a $\frac{1}{4}$ " (6 mm) bead of Six10 Epoxy Adhesive to the outlined edge of the bonding surface (or use 105 Resin based epoxy thickened with 404 or 406 filler to the consistency of peanut butter). Place the tube/stringer in position in the thickened epoxy beads. The epoxy mixture should hold it in place. Shape the epoxy bead on the outside of the stringer/panel joint into a fillet. Apply additional thickened epoxy to the joint if necessary for a smooth $\frac{1}{2}$ " (12 mm) radius fillet. If necessary, brace or tape the stringer in position until the epoxy reaches an initial cure. Apply fiberglass fabric as described in Section 3.5. Remember, more layers of fiberglass reinforcing are required over inactive cores.

3.6.4 Reinforcing with unidirectional fibers

The stiffness of reinforcement stringers can be significantly improved with little weight gain by applying unidirectional fiberglass or carbon (graphite) fibers tape along the top side of the stringer facing away from the panel. When applied to the top of the stringer, where tensile loads are highest, all of the fibers can be oriented parallel to the load. Carbon fiber is more costly than fiberglass, but savings in weight and bulk for the same amount of stiffening may offset carbon's additional cost. Refer to Section 16.4.5—*Applying Woven Cloth and Tape*, for application procedures.

Recommended Reading: *Upgrading the Cruising Sailboat* by Daniel Spurr (Seven Seas Press, Inc., Newport, RI), an excellent, in-depth discussion of strengthening the hull and deck.

4 Repairing Damaged Skins

Cut through a fiberglass boat's hull or deck and you will find either a non-cored (single skin) or a cored laminate (two skins sandwiching a lower density core material). Often a panel changes from cored to non-cored at corners, at the ends of panels and at panel openings. Depending on the size of the boat and the location of the damage, a structural repair could involve either or both types of laminate.

Whether cored or non-cored, the structure of a fiberglass boat relies on the continuity of the fibers that run through its skins. Damage from impact, abrasion, flexing or even deterioration of the resin holding the fibers in place can reduce or eliminate the load carrying ability of these fibers. The objective of the repair procedures in this section is to restore skin continuity by rebuilding the load carrying ability of the fibers through the damaged area of the skin.

The repair procedures for cores and core related damage are discussed in Section 5.

Typical fiberglass skin

Below an outer layer of gelcoat and chopped-strand mat, a typical fiberglass skin is comprised of alternating layers of woven roving and more chopped-strand mat, repeated until a required thickness is reached. In a cored panel, the schedule is similar, but the inner and outer skin are generally much thinner than a single, non-cored panel (Section 1, Figures 1-1 & 1-2). Some of the newer structures being manufactured today may include layers of unidirectional or multidirectional glass, aramid or graphite fibers. The fabric is usually bonded together with an isophthalic or orthophthalic polyester resin, although vinyl ester resins are sometimes used in place of polyester resins.

Restoring skin continuity

Skin continuity can be restored if enough fibers can be bonded across a damaged area to equal the strength and stiffness of those that were damaged or removed. The lay-up schedule for your repair work should duplicate thickness and types of materials used in that area as closely as possible. However, heavy woven roving may be replaced by more layers of lighter weight woven or bidirectional fabrics. Although more layers may mean extra work, lighter weight fabrics are often easier to find and their tighter weave results in a higher fiber to resin ratio, which can result in a repair that is actually stronger than the original panel.

As a general rule, the bonding area of the repair patch should be 12 times the thickness of the damaged skin, on each side of the damage. To maintain the necessary bonding area and keep the repair flush with the surface, the edges of the repair area are beveled to a 12-to-1 angle and each piece of repair fabric is cut progressively smaller. The bevel provides the proper bonding area and also allows the patch to be bonded below the surface where it can be faired flush with the surface.

4.1 Assessing and preparing the damaged area

Begin with a thorough inspection of the damaged area to determine the depth and extent of the repair required. If accessible, examine the back of the panel. An abrasion or flex crack that extends into the roving layers will affect the skin's strength even if the damage does not extend completely through the laminate. Cracks that are visible on the back side of a panel indicate that the fibers running through the area have lost their ability to carry their load and are structurally the same as a hole through the panel. Be sure to inspect internal structural members and hardware, too. An impact can cause panels to flex inward enough to damage adjoining bulkheads or frames. Check for excessive flexing or panel

movement. If movement is evident, reinforce the panel after the damage has been repaired as outlined in Section 3.

1. Remove all of the damaged material. Use a grinder to cut down to solid laminate or a saw to enlarge a hole to solid undamaged laminate. While you're removing the damaged material, try to maintain a circular or oval shape. The laminate around an impact site may be structurally damaged beyond the area of visible damage. Tap around the damaged area with a small hammer or metal object. Soft- or dull-sounding areas indicate a void or fracture under the surface that should be exposed.

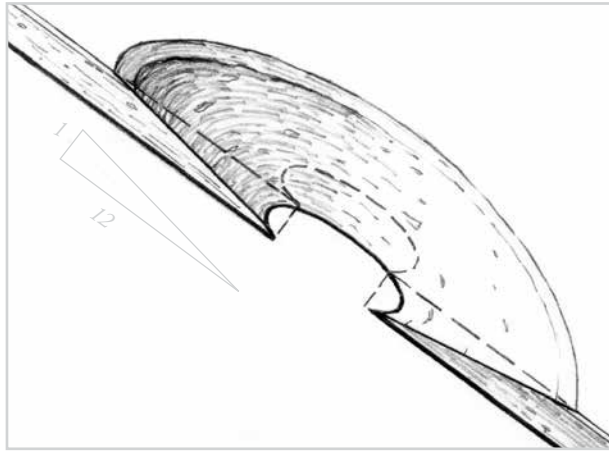

Figure 4-1 Grind a minimum 12-to-1 bevel around the edge of the excavated hole, whether the damage extends partially or completely through the skin.

2. Grind a bevel around the edge of the repair area to create a bonding area for the patch that will keep the patch flush with the skin's surface. A minimum 12-to-1 bevel is required to assure the transfer of loads across the repair area (Figure 4-1). For example, if you are left with a hole through a ¼" (6 mm)-thick laminate, the outer edge of the bevel will extend 3" (75 mm) from the inside edge of the hole. If the skin is very thin, a longer bevel angle is required.

Proceed with the laminating of the repair patch as described in Section 4.3 if:

- a.—you have reached solid, undamaged laminate without grinding through the skin.
- b.—the hole through the skin of a non-cored panel is smaller than about 1" (25 mm) in diameter.
- c.—the hole through the outer skin of a cored panel reveals undamaged core material.

Provide backing to support the lay up of the repair patch as described in Section 4.2 if:

- a.—the hole through a non-cored panel is larger than about 1" in diameter.
- b.—the hole through the inner skin of a cored panel is larger than about 1" in diameter.

4.2 Backing a repair patch

If the hole through the skin is larger than about 1" (25 mm), a backing will be required to support the wet-out fabric patch in the shape of the panel until the patch cures.

Applying a support to the back of a panel is generally not a problem if you have access to the inside of the damaged panel. But, if your boat has a fiberglass liner or if the back of the hole is inaccessible, an alternative method must be used. Several methods for backing are suggested in this manual. Use the method, or a modification of one that is most appropriate for your situation. If you are using vacuum bagging to laminate the patch, an air-tight backing is necessary for all holes.

Suggested backing supports for cored panels, with and without back access, will be discussed in Section 5. The following are suggested backing supports for non-cored panels with and without access to the back of the panel.

4.2.1 Temporary backing support—with inside access

If the hole is in an exposed interior area, the following backing method will leave the repair flush with the inner surface for easy fairing and finishing when the repair is complete.

1. Cut a piece of Styrofoam™ or similar material slightly larger than the hole you will be patching. Shape the foam as necessary to match the contour of the repair area if the panel is curved more than the foam can bend. The foam should make contact at the edges of the hole.
2. Cover the backing support with a piece of plastic and brace it against the hole from the inside. The plastic will help seal the hole and prevent the patch from bonding to the foam backing. Looking at the hole from the outside, the foam should be in contact with the edges of the opening and the plastic should be smooth and tight.

Cover the plastic with a piece of release fabric before placing the support over the hole if you prefer to leave the inner surface of the patch textured and ready for finishing.

3. With the backing support in position, laminate the repair patch as described in Section 4.3. When the repair patch has cured, remove the brace and foam. Peel the plastic and release fabric from the repair area. Fair and finish the interior side of the panel as desired.

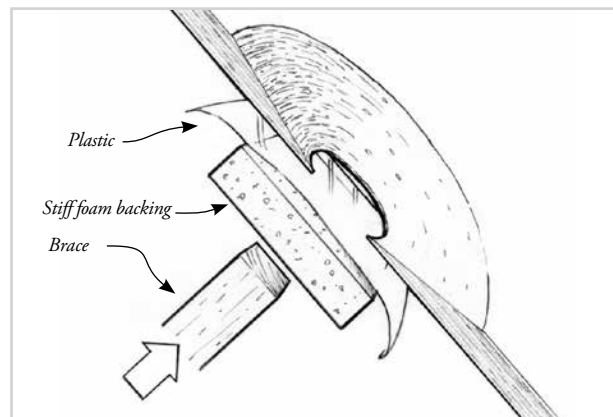

Figure 4-2 A temporary backing support should fit tight against the inside of the panel and match the panel contour.

4.2.2 Backing supports—without access

If you don't have access to the inside of the panel, the following method is designed to provide support for the repair patch by bonding a thin backer to the back of the panel from the outside of the panel. The backing will become a permanent part of the panel. Although the installation method and backing material can be altered depending on the size and curve of the repair area, the method described below can accommodate the widest range of openings. This type of backing may also be applied from the back of the panel if you have access and the permanent backing on the interior of the panel is not objectionable.

The first part of this method describes laminating a backer to match a specific opening. The second part describes slipping the backer through the hole and bonding it in place on the back of the panel.

Laminating a backing support

1. Select and tape off an area of the panel next to and several inches larger than the hole opening to act as a mold for the lay up of the backing. Mask the area outside of the tape to protect from epoxy spills. Apply overlapping strips of packaging tape or a liberal coat of automobile paste wax or release agent to the mold area. Selected an area that matches the curve or contour of the repair area.
2. Cut two pieces of 6 oz. fiberglass fabric the size of the waxed area. Add one piece of cloth for every 12" (30 cm) increase in hole diameter over 12". Lay the cloth on a plastic protected work table.
3. Wet-out the layers of fabric with epoxy. Pour a small amount of resin/hardener mixture in the middle of the cloth. Use a plastic spreader to spread the mixture over the cloth until both layers are completely saturated.



Figure 4-3 Smooth the wet-out fabric against the waxed panel to laminate a backer that matches the panel contour.

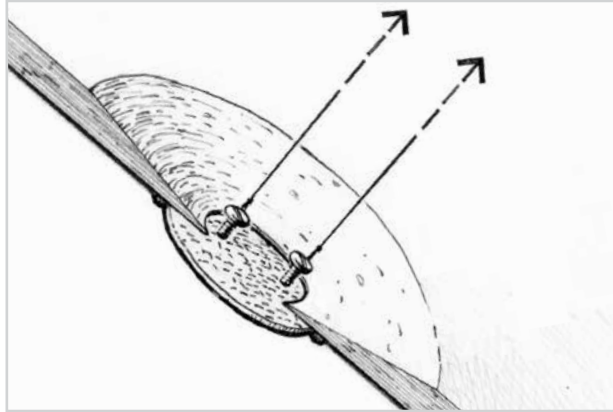

Figure 4-4 Pull the backer tight against the inside of the panel to permanently bond the backer in position.

4. Place the wet-out fabric against the waxed panel (Figure 4-3). Use a spreader to smooth the cloth against the panel and remove excess epoxy. The paste wax will prevent the cloth from becoming bonded to the panel. If the hole is in a flat or moderately curved area of the panel, the backer can be laminated on the flat table. The cured backer should be flexible enough to conform to a moderately curved panel. Allow the backer to cure thoroughly.
5. Peel the cured backer laminate from the panel (or table). Using a utility knife or scissors, trim the laminated backer to the shape of the hole, 1" larger than the hole on all sides. To help handle and hold the backer in position when bonding, screw two or more sheet metal screws into the laminate and attach a length of heavy string or wire to each screw. The string will also help retrieve the laminate if you accidentally drop it behind the panel.

Bonding the backer in place

1. Prepare the inside of the opening for bonding. Reach through the opening and sand the inside edge of the hole thoroughly with 50-grit sandpaper.
2. Bend the laminate slightly so that you can pass it through the opening using the string to keep it from dropping.

Note: Grind the hole and trim the backer to an oval shape rather than a round shape. An oval shape will allow the narrower dimension of the oversized backer to pass through the wider dimension of the smaller hole without having to flex the backer.

3. Bond the backer in place with a quick setting adhesive like WEST SYSTEM G/5® Five-Minute Adhesive. Apply adhesive to the inside edge of the hole and to the edge of the laminate. A thickened epoxy/high-density filler mixture will work if a quick curing adhesive is not available.
4. Pull the backer into position on the inside of the panel and tie off the strings to a stationary object close to the hole or around a stick laid across the hole (Figure 4-4). Keep enough tension on the strings to hold the backer in position and bend the backer as necessary to match the contour of the panel. Some of the epoxy mixture should squeeze out of the joint. Scrape away the excess and smooth the joint before it begins to cure. Allow the epoxy to cure thoroughly before removing the screws.
5. Proceed with laminating the repair patch as described in Section 4.3. The method just described works well on compound curved sections or corners. In many smaller or flat areas, other material like plastic laminate can work as a backer, as long as the patch holds the proper panel shape until it cures.

If you intend to vacuum bag the repair patch, this backing method provides a good airtight seal and should be used, even if you have access to the back of the panel. Be sure to fill the screw holes with thickened epoxy before laminating the patch. Refer to Section 4.3.3 for information on vacuum bagging for repair.

4.3 Laminating a repair patch

The new skin must be laminated to approximately the same thickness to assure the strength and stiffness of the original skin. Multiple layers of lightweight cloth will develop the same or greater strength than a single layer of heavy cloth.

The patch can be laminated by either of two methods, depending on the size of the patch. For large areas it's easier to handle and lay up each piece of cloth one piece at a time. For smaller areas it may be more convenient to wet out and lay up all of the pieces together.

4.3.1 Large area patch

1. Cut an appropriate number of pieces of fiberglass fabric the same shape as the hole. The first piece should match the outside edge of the bevel, with subsequent pieces gradually getting smaller. The final layer should match the inside edge of the bevel at the hole. The combined thickness of the layers should be slightly thinner than the original panel to allow for shaping and fairing (Figure 4-5).
2. Wet out and apply a layer of thickened epoxy to the beveled edge of the hole and to the backing piece to fill voids and provide good contact between the surface and the first layer of cloth. Thicken the mixture with 404 or 406 filler to the consistency of catsup and apply it with a disposable brush.
3. Lay the fabric in position on the repair area. Use a plastic spreader to smooth the cloth and remove trapped air.
4. Wet out the fabric. Use a plastic spreader or roller to spread the epoxy and saturate all areas of the fabric.
5. Repeat the process for each layer of fabric until you have bonded the smallest piece in place last, centered over the hole. By bonding the patch into place in a large-to-small-piece sequence, you will eliminate the possibility of sanding through any of the cloth layers when fairing the surface.

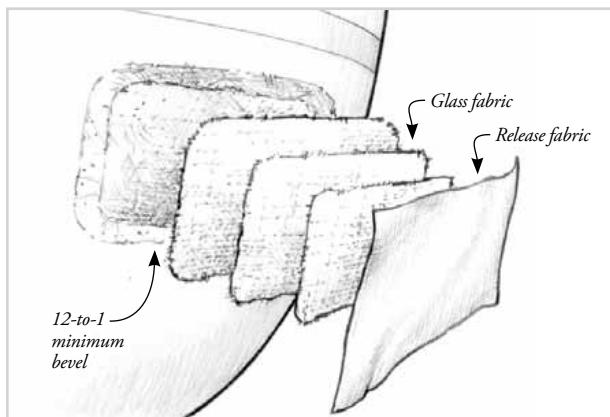

Figure 4-5 Cut an appropriate number of pieces of fiberglass fabric. The first piece should match the outside edge of the bevel.

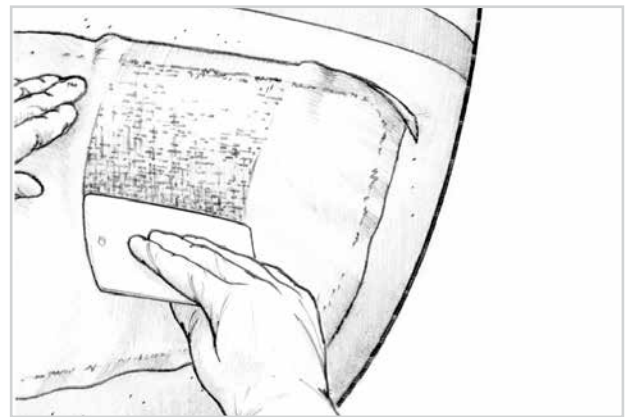

Figure 4-6 Squeegee over the release fabric with firm pressure to remove excess epoxy and smooth the patch.

6. Apply epoxy fairing compound (epoxy thickened with 407 or 410 filler) over the repair when epoxy/fiberglass patch begins to gel. Apply the fairing compound when the epoxy is still tacky. Refer to Section 14 for fairing details.

An optional method is to finish the repair in two stages. Cut a piece of 879 Release Fabric several inches larger than the patch and smooth it in place over the patch. Squeegee over the release fabric with firm pressure to remove excess epoxy and smooth the patch (Figure 4-6). Before the epoxy cures, remove the excess from the surrounding areas with a beveled mixing stick or paper towel. Allow the patch to cure thoroughly.

Remove the release fabric. Release fabric will not bond to the epoxy and will leave a smooth textured surface. Sand to remove any high spots. Fair the repair as described in Section 14. Finish the repair as described in Section 15.

4.3.2 Small area patch

If the patch area is smaller than about 8" (20 cm) on a side, it may be easier to prepare the entire patch first on a piece of plastic placed on a flat surface. The patch can then be bonded into the hole cavity in one operation.

1. Cut an appropriate number of pieces of fiberglass fabric the same shape as the hole. The first piece should match the outside edge of the bevel, with subsequent pieces gradually getting smaller. The final layer should match the inside edge of the bevel. The combined thickness of the layers should be slightly thinner than the original panel to allow for shaping and fairing.
2. Cut a piece of plastic and a piece of release fabric several inches larger than the patch area. Place the plastic on the working surface, followed by the release fabric.
3. Wet out each piece of fabric with epoxy and stack the fiberglass cloth pieces on the working surface beginning with the smallest piece and finishing with the largest. Center each layer over the previous layer. You will end up with a plug of wet-out fabric approximately the size, shape and depth of the hole (Figure 4-7).
4. Wet out and apply a layer of thickened epoxy to the beveled edge of the hole and to the backing piece to fill voids and provide good contact between the surface and the first layer of cloth. Thicken the mixture with 404 or 406 filler to the consistency of catsup and apply it with a disposable brush.
5. Lift the wet-out patch, release fabric and plastic from the work surface and press it, plastic side out, into the beveled hole cavity (Figure 4-8). Squeegee over the plastic with firm pressure to remove excess epoxy and trapped air, and smooth the patch. Before the epoxy cures, remove the excess from the surrounding areas with a beveled mixing stick or paper towel.
6. Allow the patch to cure thoroughly and remove the release fabric. Sand to remove any high spots. Fair the repair as described in Section 16.4.4. Finish the repair as described in Section 15.

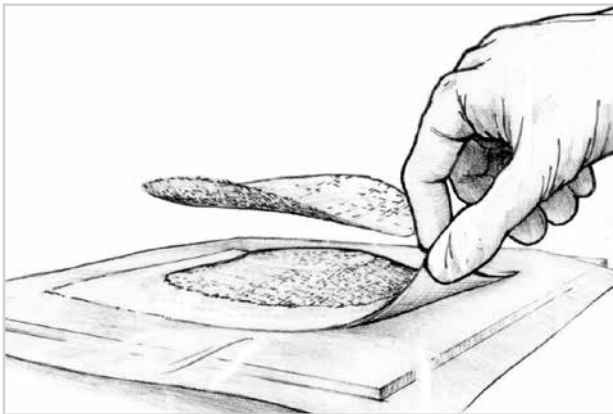

Figure 4-7 Build up a plug of wet-out fabric approximately the size, shape and depth of the hole.

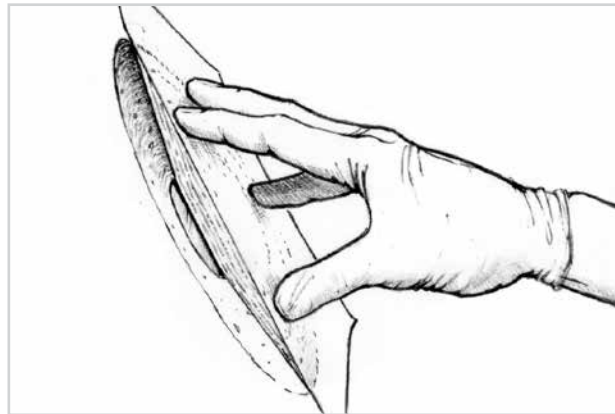

Figure 4-8 Press the wet-out patch, release fabric and plastic into the beveled hole cavity. Squeegee over the patch to remove excess epoxy and trapped air.

4.3.3 Vacuum bagging

Vacuum bagging is a clamping method that uses atmospheric pressure to apply even clamping pressure to a laminate or, in this case, the repair patch. For most repair situations vacuum bagging is not necessary for a sound repair. Vacuum bagging is useful in situations where compaction of the laminate is required, as in lightweight or high-performance structures. It is also useful in situations where conventional clamping is not practical—when bonding large areas of core material for example. The lay up procedure for vacuum bagging a small repair is the same as for the repair described above, except for the following steps:

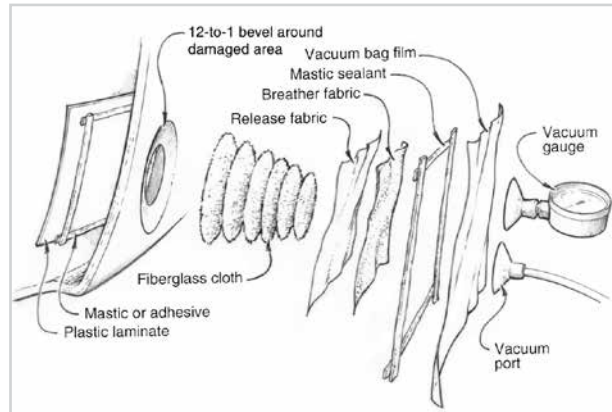

Figure 4-9 Smooth the patch and the release fabric in place. Lay the vacuum bag material over the patch, seal the bag and attach vacuum lines.

1. Prepare all vacuum bagging materials before mixing epoxy. If necessary, seal off scored or porous core material or delaminated skin and core with epoxy.
2. Apply a continuous strip of 833 Vacuum Bag Sealant or similar material around the perimeter of the repair area before mixing epoxy.
3. Laminate the repair patch following either of the above procedures.
4. After smoothing the patch and release fabric in place, lay 882 Vacuum Bag Film or similar material over the patch (Figure 4-9). Remove the protective paper from the vacuum bag sealant and press the film into the sealant around the perimeter. The lay-up must be airtight. Vacuum leaks may create a resin-starved laminate or insufficient compaction.
5. Attach the vacuum lines and pump. Begin applying vacuum pressure before the epoxy begins to cure. Check for air leaks through the back patch and around the mastic sealant. Maintain vacuum pressure until the epoxy is cured. Remove the vacuum bag and release fabric. Sand to remove any high spots. Fair the repair as described in Section 16.4.4 and Section 14—*Final Finishing*. Finish the repair as described in Section 15.

See also Appendix C, *Applying fiberglass overhead* and Appendix D, *Repairing machined holes in fiberglass laminate*.

5 Repairing Core Related Damage

As mentioned in Section 1, the core material separating the two skins of a cored panel reduces the tensile and compressive loads on the skins and allows a structural panel to withstand greater bending loads without a proportional increase in weight. To do this, the core material must remain bonded to both skins and be able to resist compression loads applied by the skins when the panel bends.

The previous section provided procedures for the repair of damaged skins. This section describes how to restore the core-to-skin bond and/or the structural properties of the core. Although the skin itself may not be damaged, it may be necessary to cut or remove a portion of the skin for access to the core. Repair or replacement of core material nearly always involves some degree of skin repair, requiring you to refer back to the procedures in the previous section.

5.0.1 Types of core related damage

Core related damage can vary from a small skin delamination with little or no actual damage to either the core material or skins, to moisture related core deterioration, to collision damage that can leave a hole through both the core and the inner and outer skins. The repair procedures in this section begin with the least damage, easiest to repair:

1. Repairing skin delamination. Often the core is wet, but still firm and usable. A delaminated area may be several square inches or several square feet.
2. Replacing damaged cores. The skin may be intact, but moisture penetration over time may have caused the balsa core to deteriorate. An impact may puncture the outer (or inner) skin and core without affecting the other skin. Even a minor puncture can allow moisture to migrate under the skin and affect strength of the core over a large area.
3. Repairing transom delamination. The plywood core may delaminate or rot as a result of moisture penetration through a crack or hole in the transom skin.
4. Repairing holed panels. An impact or modification can require rebuilding of the entire panel structure. Impact damage can extend to both skins and core or, one skin with major core damage.

The work required to repair each type of damage varies with the size of the damaged area. Often, the full extent of damage cannot be determined until you have removed a portion of the outer skin as described in Section 4.1—*Assessing and preparing the damaged area*. After a thorough inspection and assessment of the damage, follow the procedure that is most appropriate to your situation and keep in mind that the objective is to restore the structural properties of the panel by rebuilding the load carrying ability of the core and the skins to the original or greater strength.

5.1 Repairing skin delamination

Skin delamination is often first noticed when you step on a flexible or spongy area on an otherwise firm deck. Most delamination is a result of moisture damage to the skin/core bond and usually involves balsa core or plywood cored panels. Moisture entering cracks or nearby loose hardware can migrate much more easily through these cores than a foam core. Also, balsa and plywood cores are much less expensive and more widely used than foam cores in production boats. Often the core material will be wet or even saturated, but it may still be serviceable if dried thoroughly. However, if a wooden core remains wet long enough, it will begin to deteriorate and will need replacement.

Delamination can also occur in isolated pockets as a result of inadequate core bonding during manufacture. In some cases, the core may remain dry and undamaged, and simply need re-bonding.

5.1.1 Assessing delamination damage

The first step in the repair is to determine the extent of delamination and the condition of the core. Then follow the repair procedure most appropriate to your situation.

Locate and mark the extent of the damage by exerting pressure on the panel, checking for a soft feel and/or skin movement. Tap around the suspected area lightly with a small, hard object to help reveal the area of delamination. A void under the skin will sound flat or dull, compared to a more resonant sound of a solid laminate.

When you push against the surface, the delaminated skin will give easily until it hits the core. If the core is solid, the skin will appear fair when it's pressed tight against the core. If the core is damaged or deteriorated, you will be able to push the skin below the fair surface of the deck or hull. Water or air may squeeze from a nearby crack or hardware fastener.

Determine the condition of the core material by drilling $\frac{3}{16}$ "– $\frac{7}{32}$ " (5 mm)-diameter inspection holes through the skin several inches apart over the delamination. Push the skin tight against the core and drill through the core without drilling into the opposite skin. Collect the core material removed by the drill. Squeeze the core material tightly between your thumb and finger to determine whether the material is wet or dry and examine it for signs of decay. You may also insert a wire or nail through the hole to probe the core. If you hit voids or the core feels soft or punky, the core should be replaced.

5.1.2 Re-bonding delaminated skin when the core is dry

If the core material is firm and dry, re-bond the skin by injecting epoxy between the skin and core as follows:

1. Cut $\frac{1}{8}$ " (28 mm) from the tip of a WEST SYSTEM 807 syringe. Cut the tip at an angle. Fill the syringe with an epoxy/406 filler mixture thickened to the consistency of catsup.
2. Inject the epoxy mixture under the skin through each of the inspection holes. The shortened tapered syringe tip will fit tightly in the $\frac{3}{16}$ "– $\frac{7}{32}$ " (5 mm) inspection holes (Figure 5-1). You should be able to develop enough pressure to force the epoxy several inches from the hole. (You may use Six10 Epoxy Adhesive dispensed through a static mixer, though Six10 is thicker and may require the holes to be drilled closer together.)
3. Clamp the skin to the core when you are sure you have injected enough epoxy to bridge any gaps between the skin and core. Use weights, braces or sheet metal screws through the inspection holes to hold the skin tight and fair against the core until the epoxy cures. Clean up excess epoxy before it begins to gel. Allow the epoxy to cure thoroughly before removing clamps.
4. Fill any voids in the inspection holes with a thick epoxy/406 filler mixture, or Six10 Epoxy Adhesive, after removing clamps. When the epoxy has cured thoroughly, fair and finish the surface as described in Section 14—Final Fairing and Section 15—Finishing.



Figure 5-1 Inject epoxy under the skin using an 807 syringe with the tip cut off to match the hole diameter.

5.1.3 Re-bonding delaminated skin when the core is wet

If the core material is wet but still solid, re-bond the skin after the core has been thoroughly dried. One of two methods may be used to expose the core for drying.

Pattern hole drying method

This method involves drilling a pattern of holes through the skin to expose the core to air and heat and allow moisture to escape. When the core is dry, epoxy is injected under the skin and the skin and core are clamped together until the epoxy cures. This method is useful if the delamination is small, not under an area of non-skid deck or not in highly-loaded or critical laminates such as hull bottoms.

1. Drill $\frac{3}{16}$ "– $\frac{7}{32}$ " (5 mm)-diameter holes at 1" (2.5 cm) intervals, creating a pegboard-like pattern that extends several inches beyond the delaminated area (Figure 5-2). The holes should penetrate the fiberglass skin and the core without drilling into the opposite skin. Use a drill depth control device to prevent drilling entirely through the panel.
2. Dry the core thoroughly. If the core is extremely wet, start by using a high-powered shop vacuum cleaner or vacuum bagging to draw water out of the laminate. A heat lamp or radiant heater with some air movement over the area will speed the drying.

CAUTION: to be sure the fiberglass surface or the core is not damaged by excessive heat, do not heat the surface above 130°F (54°C). Proper drying may take days or weeks rather than hours. Allow the surface and core to cool to room temperature before continuing. Occasionally drill a few test holes between the existing holes to check for core dryness.

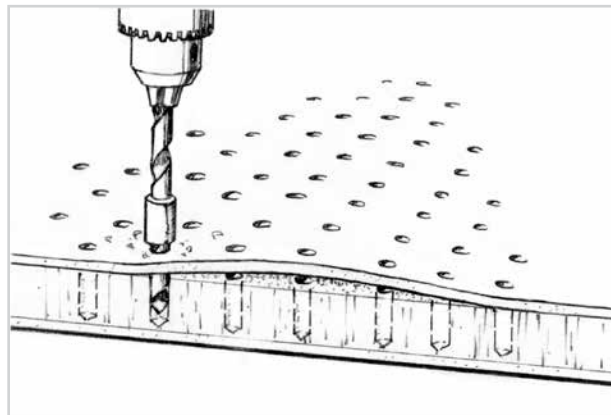

Figure 5-2 Drill a pattern of holes, 1" (25 mm) apart over the area of delamination, to allow the core material to dry out.

3. Cut $\frac{1}{8}$ " (28 mm) from the tip of a 807 Syringe. Cut the tip at an angle. Fill the syringe with a 105 Resin based epoxy mixture thickened with 404 or 406 filler to the consistency of catsup.
4. Inject the epoxy mixture under the skin through each of the holes starting in the center of the delaminated area (Figure 5-3). The shortened tapered syringe tip will fit tightly in the $\frac{3}{16}$ "– $\frac{7}{32}$ " (5 mm) holes. You should be able to develop enough pressure to force the epoxy to the surrounding holes. (You may also use Six10 Epoxy Adhesive dispensed through a static mixer, though Six10 is thicker and will require more effort to force adhesive to surrounding holes.)
5. Clamp the skin to the core when you are sure you have injected enough epoxy to bridge any gaps between the skin and core. Use evenly placed weights or braces covered with plastic to hold the skin tight and fair against the core. Sheet metal or drywall screws will also work. Whichever clamping method you use, don't distort the panel by applying too much pressure. You only need to keep the skin fair and keep the skin and core in contact while the epoxy cures. Remove the excess epoxy before it begins to gel. Allow the epoxy to cure thoroughly before removing clamping.
6. Sand the surface and fill any remaining holes with an epoxy/407 low-density filler mixture, thickened to the consistency of peanut butter (Figure 5-4). After the epoxy has cured thoroughly, sand the surface fair and finish it as described in Section 2.

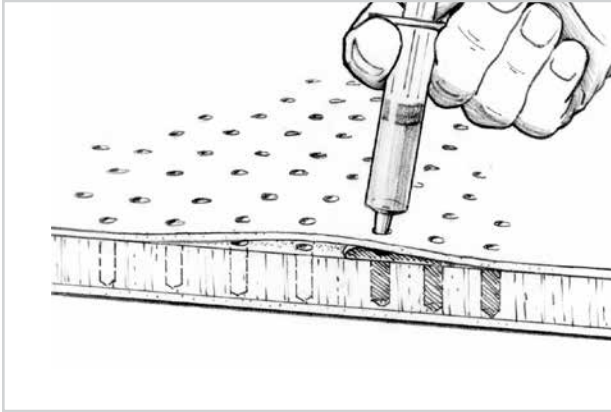

Figure 5-3 Inject the epoxy mixture under the skin through each of the holes starting in the center of the delaminated area. Fill all voids between the skin and core.

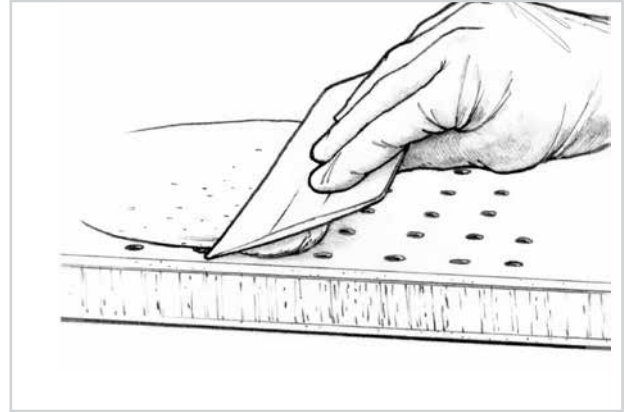

Figure 5-4 Fill any remaining voids and fair the surface with an epoxy/407 mixture.

For thin skins, this procedure may result in a weakened structure, making it necessary to bond several layers of 6 oz. fiberglass fabric over the repair area. Refer to Section 16.4.5—*Applying woven cloth and tape*.

Skin removal method

This method involves removal of a section of skin to expose the core for drying. Because of the difficulty (or impossibility) of fairing and finishing a non-skid surface, it's often easier to cut and remove an entire non-skid area. After the core is dried, the skin is re-bonded and then patched and refinished at the smooth areas outside of the nonskid. Follow the procedure in Section 5.2—*Replacing damaged cores*.

5.2 Replacing damaged cores

This method is recommended when the core is damaged and must be replaced to restore the original strength and stiffness of the laminate and when a skin delamination is in a non-skid area of a deck. After the core is replaced or dried, the skin is re-bonded to the core and a repair patch is laminated over the joint to restore skin continuity.

Remove the skin and replace the damaged core as follows:

1. Cut through the skin around the area of delamination with a panel or circular saw with a carbide tipped plywood blade or a router with a small diameter straight-fluted bit. Set the blade or bit to the depth of the skin only. On smooth surfaces cut several inches outside the area of delamination. If the delamination is in an area of non-skid, cut in the smooth area several inches outside of the non-skid area or midway between non-skid areas.
2. Remove the skin (Figure 5-5). The skin should separate easily in areas where the core is damaged or wet. In areas where the skin is well bonded to the core, use a chisel or thin blade between the skin and core to pry the skin away from the core material. Be careful not to bend the skin too much or gouge the core. Applying heat to the joint with a heat gun will also help to soften the skin core bond. Be careful not to overheat the skin.
3. Dry the core thoroughly. If the core is extremely wet, start by using a high-powered shop vacuum cleaner or vacuum bagging to draw water out of the laminate. A heat lamp or heat gun will speed the drying. If the core is undamaged, skip the core replacement and re-bond the skin as described in Section 5.2.1.
4. Remove damaged core material. Cut around the area of damage with a utility knife. Use a chisel to remove the damaged core and shave all traces of core from the opposite skin.
5. Prepare a new piece of core material to match the shape, thickness and density of the core that was removed. Dry fit the piece to be sure the new piece is no higher than the surrounding core (Figure 5-6). When replacing damaged core material, try to purchase the same material used by the builder. If that is impossible, locate a material as close as

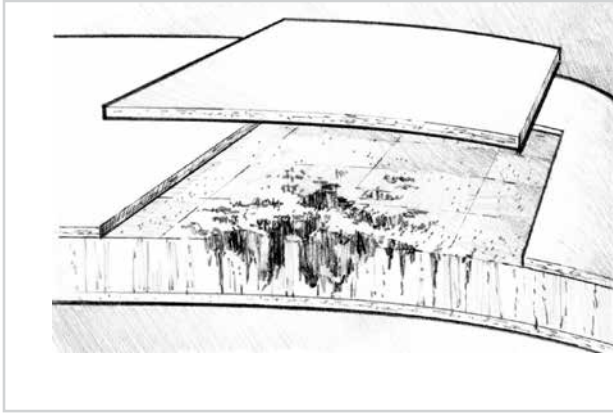

Figure 5-5 Cut through the skin only, outside of the area of delamination. Pry the skin carefully away from the core material.

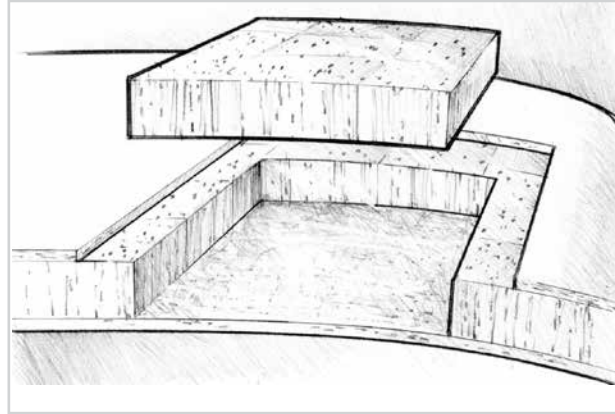

Figure 5-6 Fit a new piece of core material to match the shape, thickness and density of the damaged core material that was removed.

possible to the core's original thickness and density. It is better to have a slightly thinner core material than a thicker one.

If the damaged area is smaller than about 2"×2" (50 mm×50 mm), the area may be filled with a thick epoxy/404 filler mixture. If the core is over 1" (25 mm) thick, fill the void in multiple layers, allowing each previous layer to gel, to avoid exotherm.

If the damaged area is smaller than about 12"×12" (30 cm×30 cm) and the original core material is not available, you may substitute core material cut from soft woods like pine, fir or cedar. Cut short blocks to the length of the appropriate core thickness. For example, standard fir 2×4's, cut to ½" (12.7 mm) lengths, will yield 1½"×3½" (3.8 cm×8.9 cm) end-grained blocks that may be trimmed to fit like tiles in place of damaged ½" core.

6. Wet out the contact surfaces with a 105 Resin/hardener mixture. Then apply a liberal coat of 105 Resin/hardener mixture, thickened to the consistency of mayonnaise with 406 filler, to one contact surface. Apply enough thickened epoxy in an even layer to bridge all gaps between the two surfaces. This alternative is recommended for larger repairs. Or, apply a liberal amount of Six10 Epoxy Adhesive, dispensed through the static mixer, to the core contact area. Spread the adhesive to a layer thick enough to bridge all gaps between the two surfaces.
7. Press the core material firmly in position. A small amount of thickened epoxy should squeeze from the joint around the piece. Clamp the piece (or pieces) with plastic covered weights or braces, if necessary, to hold it in place. Smooth the epoxy at the joint and remove excess epoxy before it begins to gel. Allow the epoxy to cure thoroughly before removing clamps.

5.2.1 Re-bonding the skin

If the skin was damaged from an impact or abrasion or damaged during removal, laminate a new skin in place against the new core as described in Section 4.3. If the skin is reusable, re-bond the skin as follows:

1. Sand the surface of the core and the inner surface of the skin that was removed. Dry fit the skin for fit and to be sure that it lays flat and fair with the adjoining skin.
2. Wet out the contact surfaces with a 105 Resin/hardener mixture. Then apply a liberal coat of 105 Resin/hardener mixture, thickened to the consistency of mayonnaise with 406 filler, to one contact surface. Apply enough thickened epoxy in an even layer to bridge all gaps between the two surfaces. This alternative is recommended for larger repairs. Or, apply a liberal amount of Six10® Epoxy Adhesive, dispensed through the static mixer, to the core contact area. Spread the adhesive to a layer thick enough to bridge all gaps between the two surfaces.
3. Push the skin to the core in its original position with an equal gap (the saw cut) around all sides. A small amount of epoxy should squeeze from the joint. Clamp the skin in position

with vacuum bagging, weights, braces or sheet metal screws. Remove excess epoxy before it begins to gel. Allow the epoxy to cure thoroughly before removing clamps. Vacuum bagging is an alternate clamping method that provides equal clamping pressure over large areas.

4. Grind a 12-to-1 bevel on both edges of the joint and laminate a repair patch over the joint to restore skin continuity (Figure 5-7). The bevel will provide a recessed bonding area for the application of fiberglass fabric and allow the patch to be faired flush with the surface. The objective and procedure for patching the joint are the same as repairing damaged skins. Follow the procedure described in Section 5.3.5.

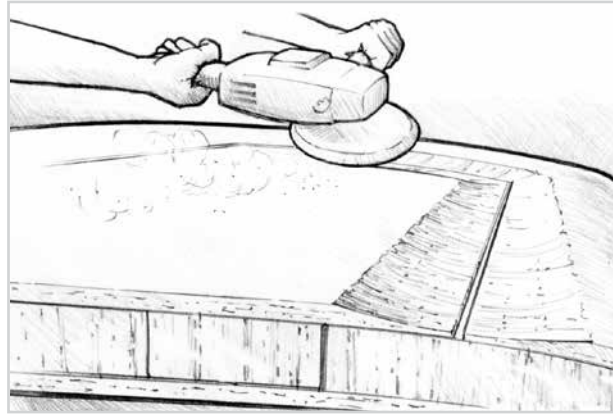

Figure 5-7 Grind a 12- to-1 bevel on the edges of the joint, so the joint repair patch can be faired flush with the surface.

Replace damaged core from below

A variation of this technique is to replace damaged core by removing the lower or inside skin and leaving the outer skin intact. Although working overhead makes this variation more difficult, the difficulty is offset by the elimination of the cosmetic work (Step 4, above) that would be required on the outside of the deck. This variation is especially useful when the repair is in a non-skid area of the deck.

The underside of a deck is often covered by a fabric liner, which can be peeled back to expose the repair area and then put back in place, hiding the repair. After removing the skin and the damaged core, replace the core as described above. Except, cut the core into convenient sizes for working overhead and use epoxy thickened enough to hold the pieces in place overhead. Immediately bond the inner skin to the core and, as necessary, use sticks to prop the entire repair in place, flush with the surrounding skin, until cured. When the repair has cured, it is not necessary to grind a bevel to make the repair flush with the surface. With the proper fabric overlap on each side of the joint (12 times the thickness of the laminate), a structural repair can be achieved without grinding a bevel. Prepare both sides of the joint to achieve a good bond and apply the layers of fabric over the joint as you would if you were applying to the bevel. When the epoxy has cured, put the liner back in place and the repair is complete.

5.3 Repairing transom delamination

Removing a section of skin to expose and replace the core is a method often used to repair delaminated powerboat transoms. Transoms are major structural parts of fiberglass powerboats, especially outboards. They not only support the weight of the motor, they maintain the shape of the boat and are a mounting point for hold-downs, towing eyes and other accessories.

Outboard motors apply a considerable load to the transom. The effects of the motor's weight are concentrated on small areas of the skin and core when the boat is accelerated under normal operating conditions, and when the boat is bouncing along on a trailer

(Figure 5-8). Over time the core is crushed and cracks develop in the skin. Moisture penetrates the plywood core, leading to delamination and eventual rot. Moisture can also penetrate the transom skin at hardware fasteners and around drain holes and I/O cutouts. All of these factors have a cumulative effect on structural failure.

Excessive motor movement may be your first sign of trouble. Tap around the suspected area lightly with a small, hard object to help reveal any areas of delamination. A void under the skin will sound flat or dull, compared to a more resonant sound of a solid laminate. Damage can be confirmed by drilling $\frac{3}{16}$ " $-\frac{7}{32}$ " (5 mm)-diameter inspection holes into the core at the suspected delamination. Examine the core material removed by the drill for signs of water or decay.

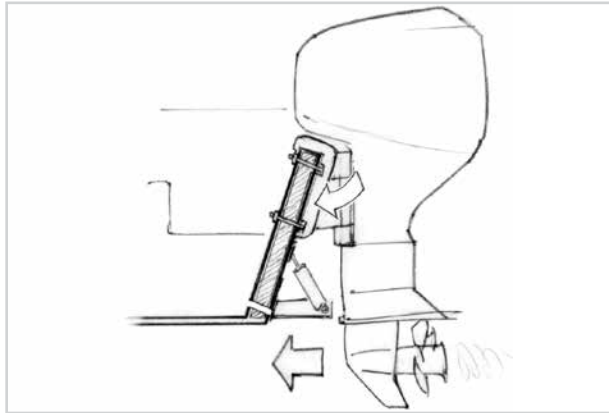

Figure 5-8 Motor loads are concentrated on the fiberglass skin and core where the mount is located. Moisture penetrates cracks in the skin, leading to delamination and eventual rot Motor weight and of the plywood core.

5.3.1 Planning the repair

The objective is to remove and replace the damaged core. Access to the damaged core is gained by removing the fiberglass skin from either the outside or, if possible, the inside of the transom. The boat's design determines which method is more practical. Interior access requires much less cosmetic finishing, but stringers, soles or decks often make interior skin removal impossible. The following method describes accessing and removing the core from the outside. If the removed fiberglass skin is in good condition, it is usually glued back in place over the new core, then structurally and cosmetically blended into the surrounding skin as described in Section 5.2.1. Support the hull to prevent sagging or distortion before removing the skin and core.

This repair is much easier if the total area affected can be confined to the transom and not extend around the corners. It is much easier to end a paint job at the corner of an object, where there is a visual break, than it is to match color and texture in the middle of an area. The following transom repair method leaves enough fiberglass around the perimeter of the transom for a proper bevel and repair patch, yet allows enough access for the damaged core to be removed and replaced. Before making a substantial cut through a structural fiberglass skin, support the hull with blocking to maintain the hull's shape.

Determine the location of the cut

After removing the motor, hardware and trim, measure the fiberglass skin thickness at one of the holes in the transom. The fiberglass thickness determines the bevel length and the distance of the cut line in from the corners. The bevel length is at least 12 times the fiberglass thickness.

A 12-to-1 bevel allows room for multiple layers of fiberglass fabric and epoxy across the cut line to restore strength to the fiberglass skin. If the fiberglass skin is $\frac{1}{8}$ " (3 mm) thick, the width of the bevel will be at least $1\frac{1}{2}$ " (36 mm). If the fiberglass is $\frac{1}{4}$ " (6 mm) thick, the cut line will need to be at least 3" (76 mm) in from the corners to allow for a 3" bevel. If the original fiberglass skin is reused, the same bevel is required on each side of the cut after the skin is re-bonded to the new core.

Layout the cut line on the transom the required distance from the edges. Measure from the end of the rounded corners where they blend into the flat transom surface.

5.3.2 Removing the damaged skin and core

The skin removal method as described above for deck or hull panel delamination is essentially the same for transom delamination. Often, if the core has been wet for a period of time, the plywood veneers will begin to delaminate and much of the veneer may have rotted away. Remove the outer (or inner) transom skin and plywood core as follows:

1. Cut through the skin at the cut line established by the bevel length. Use a panel or circular saw with a carbide tipped plywood blade or a router with a small diameter straight-fluted bit. Set the blade or bit to the depth of the skin only.
2. Remove the skin. The skin should separate easily in areas where the core is damaged or wet. In areas where the skin is well bonded to the core, use a chisel or thin blade between the skin and core to pry the skin away from the core material. Applying heat to the joint with a heat gun can help to soften the skin core bond. Be careful not to overheat the skin. Avoid damaging the skin by over bending or using too much force when prying the skin from the core. It is worth the effort of getting it off in one piece.
3. Inspect the condition of the plywood core material. If the plywood is sound but wet, you may be able to dry it and re-bond the skin. Drying a saturated transom core thoroughly may take weeks or months. Unless you have plenty of time to allow for drying, over a winter season for example, you may consider replacing all the core. If you are able to dry a sound core, fill any minor voids or delaminations or end grain in the dried core while it is uncovered. Follow the skin replacement instruction in Section 5.3.1.

If, however, the plywood has deteriorated or dry rot has set in, the plywood should be replaced. Even if the core damage is isolated to some portion of the transom, you may want to consider replacing all of the plywood core rather than repairing it.

4. Remove the damaged plywood core (Figure 5-9). Use a chisel or whatever combination of tools you need to remove all damaged material. The plywood core in the perimeter and corners of the transom will be the biggest challenge. If necessary, use large drill bits to carefully weaken and re-move stubborn areas. Rotary rasps can also be effective. Home made tools similar to a grub hoe or an adz can be used to remove the stubborn perimeter areas. Shave all traces of the core material from the inner skin, being careful not to damage the skin. Make any necessary repairs to the inner skin. Sand the skin to prepare for bonding.

5.3.3 Preparing a new transom core

Prepare a new plywood core to match the shape and thickness of the core that was removed. Try to use the same grade plywood (or better) that was used in the original core. Marine grade plywood is ideal for this repair. If marine grade plywood is not available, use more layers of thinner AB grade exterior plywood. Be sure to fill any voids in the plywood edges with thickened epoxy after the panels are cut into shape.

Because the opening is smaller than the core we are replacing, the plywood will have to be installed in multiple layers made up of smaller pieces of the same type of plywood, laminated to equal the thickness as the original core (Figure 5-10). For example, if a 1½" (38 mm)-thick core consisted of two sheets of ¾" (19 mm) plywood, it would be better to

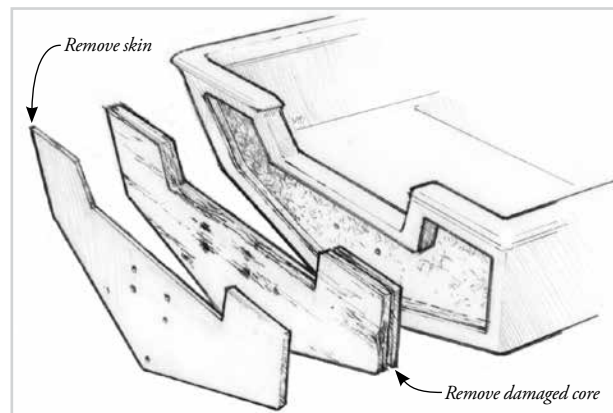

Figure 5-9 Cut through the outer skin at the perimeter of the core. Remove the skin and the core if it is delaminated or rotted.

lamine three sheets of $\frac{1}{2}$ " (12.5 mm) or four sheets of $\frac{3}{8}$ " (9.5 mm) to equal the original $\frac{1}{2}$ " core thickness. Trim and dry fit the new pieces of core to fit the void left by the old core.

Make a template of the transom core and use it to layout the plywood layers. Because the opening in the transom skin is smaller than the full sized plywood core, you will need to replace each layer of the core in pieces (Figure 5-10). Cut each layer into pieces small enough to fit through the opening in the transom skin. Stagger the joints in each layer, by at least eight times the plywood thickness, from joints in the adjoining layers. For example, a 3" (76 mm) stagger will be required between joints when using $\frac{3}{8}$ " (9.5 mm) plywood. Ideally these joints are staggered widely. Joints can also be run at different angles to stagger them even more.

Joints near the sides of the transom will affect strength less than joints near the middle. Remember, the cantilevered load of an outboard motor puts significant loads on the middle of the transom. If joints in the layers are scarfed with an 8:1 bevel rather than butted, joint location is not an issue.

Before mixing epoxy:

- Plan all of the installation steps. The layers can be glued in place in one continuous operation or over several sessions.
- Label the pieces and dry fit them in the transom to eliminate potential problems during actual assembly. The fit need not be perfect—thickened epoxy will bridge gaps.
- Use 206 Slow Hardener for extra working time. Use 209 Extra Slow Hardener if you will be working in warm temperatures.
- Be sure you and any parts of the boat you do not want to get epoxy on are protected.
- Be sure all parts, tools and clamps are within easy reach. Drywall screws are a practical clamping method for a plywood transom lay-up. Clamps, wedges or prop sticks can also be used. Bolts with nuts and oversized washers can be used in places where holes will eventually be required—motor mount holes and drain holes.

5.3.4 Installing the new core

If you will be working alone and wish to accomplish the repair in manageable steps, laminate the new pieces of plywood core in place as follows:

1. Prepare all bonding surfaces. Check the condition of the inner skin and make repairs as necessary. Sand rough surfaces. Remove all loose material and dust.
2. Wet out the bonding surfaces of the inner fiberglass skin and first piece of core with epoxy. Apply extra epoxy to the plywood end grain.
3. Coat the bonding surfaces of the inner skin and hull edges with an epoxy mixture thickened with 403 or 406 filler to the consistency of mayonnaise. (Or, use Six10 Epoxy Adhesive dispensed through a static mixer.) Use a notched spreader to apply enough thickened epoxy to bridge all gaps between the core piece and the skin and the edge of the core and the hull. Avoid over-thickening. The epoxy needs to move under minimum pressure. Adjust viscosity by adding more or less filler to achieve consistency between that of catsup and mayonnaise.
4. Place the first piece of plywood in position against the coated skin (Figure 5-10). Clamp the piece in place with drywall screws (and oversized washers) through the inner skin to draw the pieces of core tight to the inner skin. Coat the screws with a mold release for easy removal. A small amount of epoxy should squeeze from the joint around the core. (Fill the screw holes with epoxy after the lay-up has cured and the screws removed.)
5. Repeat the process for the remaining pieces of the first layer. Fill any gaps and smooth the epoxy at the joints. Remove excess epoxy before it begins to gel. Allow the epoxy to cure thoroughly before removing screws, clamps or vacuum pressure. Once cured, you have a rigid base against which you can glue or laminate the remaining plywood one layer at a time.
6. Recheck the fit of the final pieces and be sure to sand cured epoxy coated surfaces prior to laminating additional plywood layers.

7. Repeat the process for each layer. Use drywall screws to draw the new layer down to the first layer. Remove the screws and fill the holes with epoxy after the epoxy cures. You may leave the fasteners in place only if they are stainless, galvanized or bronze.

An alternative method is to install and clamp all the layers in place at the same time if a very slow curing hardener (209 Extra Slow) is used. Dry fit and label all of the parts. Apply unthickened epoxy to all of the plywood segments, especially the end grain around the perimeter of each piece, before applying thickened epoxy. Pieces can be temporarily clamped with drywall screws. Remove and replace the screws as each layer is installed. You may also use C-clamps, prop-sticks braced against a wall or bolts and oversized washers in holes that will be used for through-hull fittings.

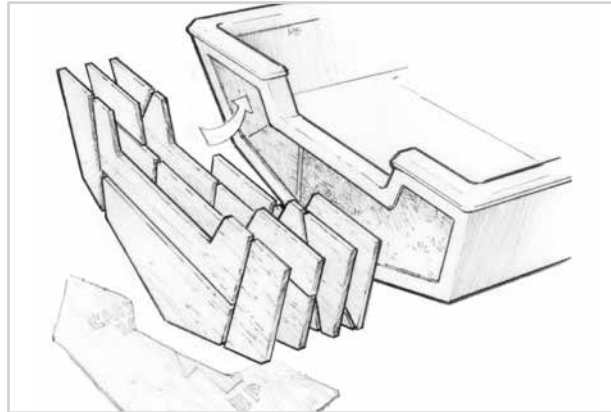

Figure 5-10 Bond a new plywood core in place. Laminate sheets of thinner plywood to equal the thickness of the old core. Trim the pieces to fit the void left by the old core—use a cardboard template to layout pieces. Cut the pieces as necessary to fit opening.

5.3.5 Replace the fiberglass skin

After the core replacement is complete, the original fiberglass skin can be laminated over the new core or if necessary a new skin can be laminated over the core.

A transom skin is often reusable except for a relatively small damaged area around the motor mount. If the damage is limited, it may be easier to repair the damage in the center of the skin, after re-bonding the skin, rather than laminating a new skin over the entire transom. Repair the skin using the appropriate procedure in Section 4 after the skin is replaced. Re-bond the original skin as follows:

1. Sand the bonding surfaces of the core and the skin. If the skin was repaired, be sure the back side of the repair is sanded flush. Dry fit the skin to be sure it lays flat and fair with the adjoining skin.
2. Wet out the bonding surfaces of the core and skin with epoxy. Bond the skin to the core in its original position using the same laminating techniques used to bond the plywood core in place. Alternatively, you may use Six10 Epoxy Adhesive to bond the skin in place.
3. Clamp the skin with drywall screws driven through plywood blocks or oversized washers. Large blocks or washers spread the holding power of the screws over a larger area and prevent dimples in the fiberglass skin that would require filling and fairing later. Use pieces of plastic sheet or plastic packaging tape under the washers or blocks to prevent bonding to the skin. Allow the epoxy to cure. Remove the screws, bevel the edges of the holes and fill them with epoxy.
4. Grind a minimum 12-to-1 bevel on both sides of the joint. The outside edge of the bevel should be short of the corner, as described earlier in Section 5.3.1—Planning the repair. Laminate a repair patch over the joint to restore skin continuity (Figure 5-11). The bevel will provide a recessed bonding area for the application of fiberglass fabric and allow the patch to be faired flush with the surface. The procedure for patching the joint are the same as repairing damaged skins. Follow the procedure described in Section 4.3. Limit the patch and finishing to the transom side of the corners.

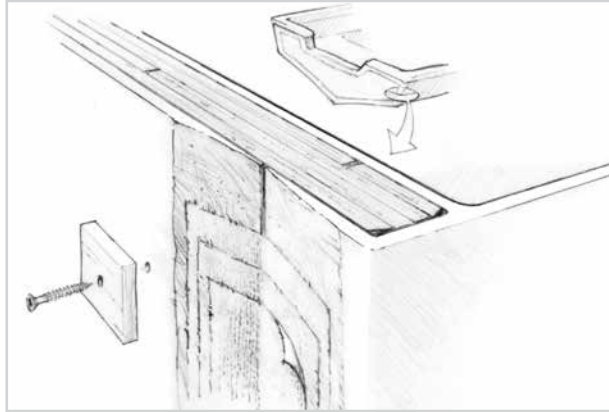

Figure 5-11 Grind a minimum 12-to-1 bevel on both sides of the joint. Laminate a repair patch over the joint to restore skin continuity.

5.3.6 Laminating a new transom skin

If your fiberglass skin is unusable, plan to laminate a new fiberglass skin over the core with multiple layers of fiberglass and epoxy. Apply enough layers to equal the same thickness as the original skin. See the fabric thickness chart in Appendix B. Layers can be applied immediately or while the previous layer is still tacky. If the epoxy is allowed to cure beyond being tacky, allow it to cure overnight, then wash the surface with water and sand the surface to prepare it for more layers. Laminate the new skin so it extends to the edge of the 12-to-1 bevel that was machined earlier on the outer edges of the transom. Install the biggest patch first with each layer being progressively smaller to fill the 12-to-1 bevel. For additional information on laminating a large new fiberglass skin see Section 4.3.

1. Grind a 12-to-1 bevel around the remaining edge of the transom. The outside edge of the bevel should be short of the corner, as described earlier in Section 5.3.1—Planning the repair.
2. Cut the appropriate number of fabric pieces to the size and shape of the transom. Cut the first piece $\frac{1}{4}$ " from the outer edges of the bevel. Cut each of the remaining pieces smaller on each side than the piece below it. The final piece should be the same size as the inner edge of the bevel. The edges of the middle pieces should be evenly spaced between the edges of the first and last pieces. The spacing depends on the number of pieces (equaling the laminate thickness) and the length of the bevel.
3. Wet out the transom core and bevel with epoxy. Using a plastic spreader, coat the transom core with a thin even layer of an epoxy mixture thickened with 403 or 406 filler to a mayonnaise consistency. (Or, use Six10 Epoxy Adhesive dispensed through a static mixer.)
4. Wet out the cloth with epoxy on a work surface covered with plastic sheeting. Apply enough epoxy to saturate the cloth using a thin foam roller or by pouring epoxy onto the fabric and spreading with a plastic spreader.
5. Place the fabric on the transom, centering it within the edges of the bevel. Smooth the fabric into the thickened epoxy layer with a plastic spreader. Use the spreader to remove trapped air and excess epoxy and to smooth the fabric against the surface.
6. Wet out and apply each of the remaining fabric layers with epoxy, ending with the smallest piece. Apply each layer before the previous layer becomes tack free. Smooth each layer with a plastic spreader to remove wrinkles, trapped air and excess epoxy (Figure 5-12).
7. Apply several coats of epoxy over the fabric to fill the weave of the fabric when the epoxy has reached a gel stage. Use the thin foam roller to apply each coat after the previous coat reaches its gel stage and before it becomes completely tack free (to avoid sanding between coats). Allow the final coat to cure thoroughly.
8. Wash and sand the final coat after it has cured thoroughly. Sand and fair in the edges of the fabric to blend with the hull surface. Any flaws or unevenness can be faired with a thick mixture of epoxy and 407 or 410 Microlight. Seal filled and sanded surfaces with epoxy and wet sand to prepare the surface for paint.

Be sure to coat and seal the end grain of all holes drilled through the transom with multiple coats of epoxy. This is not a waste of time. If the holes are not properly sealed,

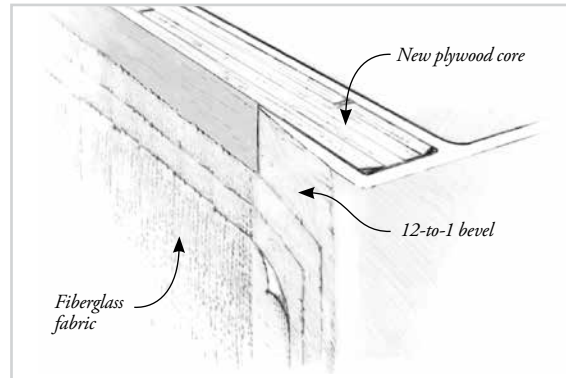

Figure 5-12 Wet out and apply each layer of fabric with epoxy, ending with the smallest piece. Smooth each layer with a plastic spreader to remove wrinkles, trapped air and excess epoxy.

plan on replacing the core again in the future. If all sources of water are eliminated by sealing the wood in epoxy, the repair should be better than new and last indefinitely. Remember to coat screw holes with epoxy just prior to installing screws for motor mounts and transom hardware. Apply mold release (or vegetable oil cooking spray) to the fasteners prior to gluing them in place if you plan to remove them at some point in the future.

Replacing the core and both skins

If you can't separate the skins from the core or if the skins and core are damaged beyond repair, cut the entire transom section out, and bond in a new core as follows:

1. Cut away the transom by sawing through the skins and core at the perimeter of the transom. Prepare the bonding area by sanding away any rough or uneven edges around the hole perimeter. Be sure the hull is supported to prevent distortion.
2. Prepare the transom core replacement as described in Section 5.3.3. Bond the plywood pieces together on a flat surface or a surface matching the curve of the transom. Trim the perimeter of the new core, checking the piece for fit in the exact position of the old core. Be sure the hull is set up square and true before bonding the new transom in place.
3. Bond the new core in position. Wet out the bonding surfaces of the new plywood core and the hull with epoxy. Use particular care to thoroughly wet out the end grain of the plywood. Coat the bonding surfaces of the core and hull with an epoxy mixture thickened with 403 or 406 filler to the consistency of mayonnaise. (Or, use Six10 Epoxy Adhesive.) Use enough of the mixture to ensure no voids remain between the two surfaces when the core is positioned.
4. Clamp or brace the core in position until the epoxy cures. Use only enough clamping pressure to restrict movement and squeeze out some of the mixture. Remove the excess thickened epoxy or use it to fill any voids in the joint before it begins to gel. Align the core in the exact position of the old core and allow the epoxy to cure thoroughly before removing clamps.
5. Re-bond reusable skins as described in Section 5.3.5 or laminate new skins following the procedures in Section 5.3.6.

5.4 Repairing holed panels

Minor impacts or abrasions can include dropping a cooler or sharp tool on the deck, rubbing against a dock or the weight of an outboard motor mount against a transom. This type of damage often results in a hole or crack through one skin and possible skin delamination around the impact. If the damaged area has been submerged or left unprotected for a period of time, water penetration can lead to further delamination and eventually rot. Most minor impact damage can be repaired with procedures previously described.

Major impact damage is often associated with collisions, groundings, natural disasters and occasionally traffic accidents. The amount of damage depends on the force of the impact and the shape of the object being hit. In this case, we are referring to structural damage through the core and both skins. Damage may mean a fracture that results in loss of skin continuity or a hole several feet across. There is also a strong possibility the impact that

damaged the panel may have caused internal structural damage to bulkheads, frames, etc. Any such damage should be repaired prior to undertaking the repair of the cored panel.

The objective in repairing holes through cored panels is to replace damaged core material and restore skin continuity to both skins. The sequence of skin and core replacement will vary depending on access to the back of the panel.

5.4.1 Repairing holes through cored panels with back access

After preparing the hole, replace the core material and laminate the inner and outer skin to the core as follows:

1. Prepare the hole by cutting away ragged or damaged skin. Cut back to undamaged core and skin while maintaining a circular or oval hole shape. Grind a minimum 12-to-1 bevel on the edges of the inner and outer skins at the hole to provide adequate bonding surface when re-laminating the skin repair patches. For example, if the skin is $\frac{1}{4}$ " (6 mm)-thick, the bevel will extend 3" (76 mm) from the edge of the hole (Figure 5-13).
2. Prepare a temporary backing to support the core while bonding it in position and while laminating the new outer skin patch. Cut a piece of low-density insulating foam slightly larger than the hole opening. Bevel the edges of the foam so the face of the foam is flush with the inner skin/core bond line. Cover the foam with 4-6 mil plastic and brace it in position against the inner edge of the hole. If the foam is too stiff to conform to a curved panel shape when braced from the back, sand the foam to a shape that matches the panel curve (Figure 5-14).
3. Prepare a new piece of core material to match the shape, thickness and density of the core that was removed. Dry fit the core to match the shape and contour of the core that was removed. When replacing damaged core material, try to purchase the same material used by the builder. If this is impossible, locate a material that is as close as possible to the core's original thickness and density. Cut the core into smaller pieces as necessary to conform to curved panels.
4. Wet out the edges of the hole and edges of core material with epoxy. Apply a layer of epoxy mixture thickened with 403 or 406 filler to the consistency of peanut butter to the inside edges of the hole and edges of core material. Alternatively, you may apply a layer of Six10 Epoxy Adhesive to edges of the hole and core or core pieces without wet out.
5. Place the core material in position. If the epoxy mixture will not hold the core in place or if it will not conform to the panel contour, use braces to hold it in position. Smooth any excess epoxy at the joint and fill any voids in the joint before the epoxy begins to gel. Allow the epoxy to cure thoroughly.
6. Laminate a new outer skin repair patch following the procedure in Section 4.3. Finish the repair following the procedure in Section 2.
7. Laminate a new inner skin repair patch following the procedure in Section 4.3, after removing the temporary backing support. Finish the repair as desired.

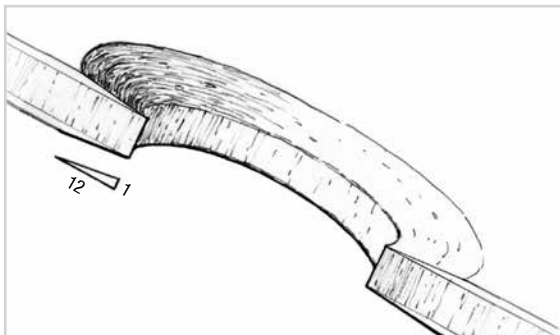

Figure 5-13 Grind a 12-to-1 bevel on the edges of the inner and outer skins.

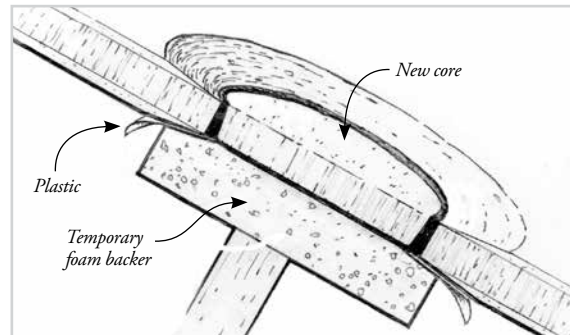

Figure 5-14 Brace a temporary backing against the back of the hole to support the new core.

5.4.2 Repairing holes through cored panels without back access

The difference between repairing holes with or without back access is in the sequence of steps. Without back access it's necessary to laminate the inner skin first, replace the core, and then laminate the outer skin. Laminating the inner skin from the outside requires additional preparation, as follows:

1. Prepare the hole by cutting away ragged or damaged skin. Cut back to undamaged core and skin, while maintaining a circular or oval hole shape.
2. Cut back the outer skin and core several inches from the edge of the hole through the inner skin to provide an area wide enough to grind a 12-to-1 bevel around the edge of the inner skin (Figure 5-15). Use a router with a straight fluted bit set to the depth of the outer skin and core only, to avoid cutting the inner skin. Cut the core and outer skin back 12 times the thickness of the inner skin plus about 1" (25 mm) to leave enough room to grind the inner skin bevel. For example, if the inner skin is $\frac{1}{4}$ " (6 mm)-thick, the bevel will extend 3" (7.5 cm) from the edge of the hole. The core and outer skin should be cut back about 4" (10 cm) from the edge of the hole through the inner skin.
3. Grind a minimum 12-to-1 bevel around the inner edges of both skins to provide adequate bonding surface when re-laminating the skin repair patches (Figure 5-16).
4. Bond a permanent backer to the back side of the inner skin following the procedure in Section 4.2.2. The backer should match the contour of the panel.
5. Laminate a new inner skin repair patch following the procedure in Section 4.3.
6. Bond a new piece of core material in place against the new inner skin.
7. Laminate a new outer skin repair patch following the procedure in Section 4.3. Finish the outer skin following the procedures beginning in Section 15—*Finishing*.

The information in Sections 2, 3, 4 and 5 is intended to provide a range of repair procedures for typical cored and non-cored fiberglass structures. Individual procedures or the sequence of procedures may be altered to suit your situation. Keep in mind that the objectives in repairing the fiberglass structure are to restore skin continuity and structural properties of the core to equal or greater strength than the original.

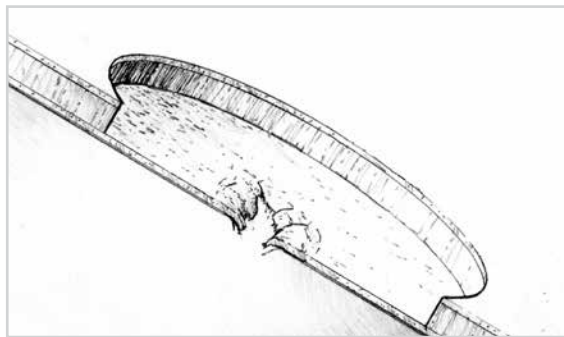

Figure 5-15 Cut back the outer skin and core several inches from the hole through the inner skin.

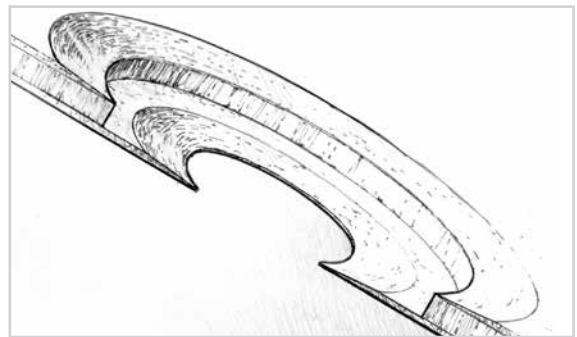

Figure 5-16 Grind a 12-to-1 bevel around the edge of the inner and outer skins.

6 Repairing and Upgrading Soles and Decks

A common source of problems on open runabouts and pontoon boats is the cockpit sole or deck. Poorly installed soles and decks are prone to delamination and rot. The first part of this section describes how to remove and replace damaged plywood decks. The second part describes how to install a teak veneer deck that is a practical and beautiful option for finishing a deck repair.

6.1 Repairing delaminated soles and decks

On runabouts, the plywood cockpit sole is usually just a layer of plywood screwed down to the top of stringers and frames and “tabbed” or joined to the hull sides with fiberglass tape at the edges of the plywood and up the side of the hull a few inches. Some runabouts will also have a layer or two of fiberglass fabric over the top of the plywood with a non-skid pattern molded in. Many have a layer of carpet or vinyl flooring material glued onto the plywood that can trap moisture and contribute to delamination and rot.

Moisture enters the plywood end grain alongside the screws holding the sole down to the framing as well as the fasteners holding the seats, coolers, and other items to the sole. (Moisture also penetrates and damages the stringers supporting the sole, See Section 3—*Repairing Stringers and Floors*.) In addition, there is seldom any fiberglass or resin coating to seal the back side of the plywood, so moisture also enters the plywood from below the sole where the air is often damp and stagnant.

When the plywood begins to delaminate, the deck will feel spongy underfoot. This is disconcerting and unsafe to walk on, and also reduces the athwartship (side to side) hull stiffness the sole would normally provide. If not repaired, the plywood will rot. This situation can be avoided if the builder takes care to seal any penetrations into the plywood.

If moisture damage is severe enough, replacing the affected plywood is often necessary. The following procedure describes sole replacement in a runabout. A pontoon deck would be repaired in much the same way, but it will usually be fastened with screws around perimeter framing.

6.1.1 Removing the damaged sole

1. Remove any equipment or hardware screwed down to the sole. This may include things like seat bases, cooler brackets, and step or ladder brackets.
2. Pull up any carpeting or covering to expose the fasteners or tabs used to hold the plywood down on top of the frame and stringer system. If there are cutouts in the sole for access to storage compartments below, carefully remove any trim around the cutout. You will probably want to reuse that once the new sole is in place.

Before cutting tabs or removing any of the fasteners, make sure the hull is supported so that its sides do not move once the sole is no longer supporting them. In many boats, this will not be a problem, but there are some hulls that will be very floppy when the sole is out. If the new sole is installed while the hull is out of shape, the hull will stay that way.

3. Cut through the fiberglass at the sole/hull joint if the plywood is tabbed to the hull with fiberglass tape or if the sole is covered with a layer of glass (Figure 6-1). Remember that this is not a 90° joint—the hull is angling toward the centerline. Make sure you are not going to cut into the hull laminate as you are cutting the tab. Remove all of the fasteners. The sole may be screwed to butt blocks between plywood sections, cleats attached to

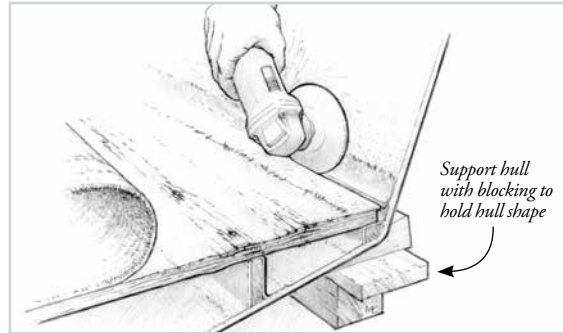

Figure 6-1 Cut through the fiberglass at the sole/hull joint if the plywood is tabbed to the hull with fiberglass tape or if the sole is covered with a layer of glass.

CAUTION! Do not cut into the hull laminate.

the hull at the perimeter, and stringers near the center of the sole. Pontoon decks will be screwed or bolted around the perimeter.

4. Remove the pieces of plywood. If you remove them carefully, you can use them as patterns for the new sole. If only a portion of the sole is damaged, you can cut out a section of the sole. If there is no structural member below it to make a good place for a joint, use cleats bonded under the edge of the remaining original deck to set the new plywood on.

The sole may be bonded to the stringers and cleats supporting it. If necessary, cut the sole out in sections then chisel and grind away any material bonded to the tops of the stringers.

6.1.2 Installing the new sole

The moisture that damaged the plywood sole could have also damaged the stringers and floors supporting it. It's a good idea to inspect and repair all damage to the structure below the sole before reinstalling the sole. If the structure is in good shape, reinstall the sole as follows:

1. Cut out new pieces of plywood using careful measurements or the patterns from the old sole. Make sure the new plywood is at least the same thickness as the original material.
2. Dry fit the sections and drill any fastener holes, and then remove the section.
3. Coat the back side with two or three coats of epoxy before reinstalling to prevent moisture from penetrating the bottom of the new sole. It is also very important to completely seal the edges of the plywood and the fastener holes. Sealing the edges of the plywood is especially important at the edges of a deck on a pontoon boat. If using Douglas fir plywood, you should use a light layer of woven fiberglass fabric on top to prevent checking—6 oz. glass is usually sufficient.
4. Bond the new plywood sole to the hull, to the stringers and floors, and to any cleats installed to support the edges of the plywood between stringers. Use Six10 Epoxy Adhesive or a 105 Epoxy mixture thickened with 403 or 406 filler to bed the plywood into. For partial replacement of the plywood or multiple sheets of plywood, dish out the joint between plywood pieces with a grinder and join the pieces together with fiberglass tape to make a continuous panel.

Or, in the case of a pontoon deck, install the new deck by screwing the plywood down to the stringers. Coat the fastener holes with epoxy before inserting the screws. This will prevent moisture from getting into the plywood end grain at the fastener holes. We usually coat or fiberglass the top side after the sole is installed.

6.1.3 Tabbing the sole to the hull

1. Prepare the hull surface for bonding by sanding a 4"–6" (10 cm–15 cm) wide strip on the hull above the sole with 80-grit sandpaper.
2. Apply a fillet of 105 Resin/hardener mixture, thickened to the consistency of mayonnaise with 406 filler, or Six10 Epoxy Adhesive all along the hull-to-sole joint. This will fill any gap between the plywood and the hull and allow the fiberglass tabbing to lay easily across the joint.
3. Apply 4" (10 cm)-wide 727 Biaxial fiberglass tape over the fillet (Figure 6-2). Wet out the tape with epoxy. If necessary apply multiple layers of tape to build up to the same thickness as the original tabbing. Stagger the edges of the tabbing when using multiple

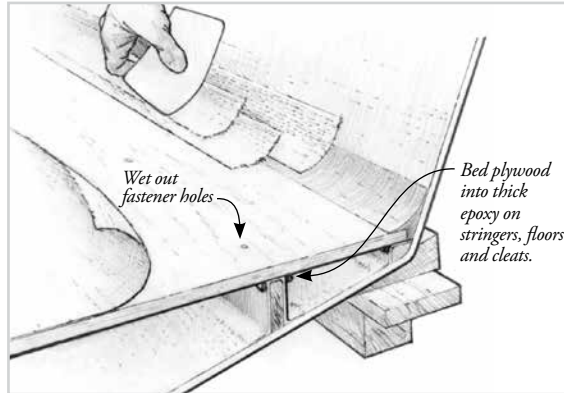

Figure 6-2 Apply fiberglass tape over the fillet. Stagger the edges of the tabbing when using multiple layers so they do not end in the same place on the hull side or sole.

layers so they do not end in the same place on the hull side or sole. Apply the first layer up the side 3" (7.6 cm) or so, the second layer 3" out on the sole, and the third layer centered over the corner. This creates an aggregate build up three layers thick on the corner without causing a hard spot at the edges of the tabbing. The tape can be applied over the uncured fillet or after it is thoroughly cured and sanded.

4. Reinstall the carpeting or covering after the epoxy is cured. If painting the sole, make sure you wet sand the surface to remove all gloss before priming and painting or installing a teak surface. When reinstalling seats and deck hardware, be sure to seal the fastener holes with epoxy. This will prevent the same type of damage from recurring.

6.2 Installing a teak deck

Installing a teak deck is a practical and beautiful option for finishing a deck or sole repair, or for simply improving the looks and value of a boat. The thickness of the teak determines which of two methods are used to install it. With both methods, the teak is bonded to the substrate with epoxy. Bonding with epoxy not only seals the deck with an epoxy moisture barrier, but it eliminates the many fasteners that penetrate conventional teak decks and are often a source of leaks.

Thinner teak veneers ($1/8$ "– $1/4$ " (3 mm–6 mm) can be applied to decks, seats, cabin tops or hatches without adding excessive weight. When installing veneers, the gap between the strips is filled with an G/flex[®] 655 Thickened Epoxy mixed with 502 Black Pigment or 423 Graphite Powder, to give you an authentic teak deck that is both durable and low in maintenance.

Thicker teak planks ($1/4$ "– $3/4$ " (6 mm–19 mm) are also bonded to the substrate, but the gap between planks is filled with a flexible caulk more suited to the greater expansion and contraction of thicker material. This is similar to traditional methods, but with the advantage of a reliable moisture barrier under the teak and no fasteners penetrating the substrate.

6.2.1 Installing teak veneers

Although strips of up to $1/4$ " (6 mm) thickness may be used, the effects of dimensional change can be limited by using thinner, $1/8$ " (3 mm)-thick strips. A $1/8$ "-thick deck will provide you with years of service in high-traffic areas, and it will keep the additional weight of a new teak deck to a minimum. Strips should be $1\frac{1}{2}$ "–2" (38 mm–50 mm) wide, with edges planed smooth and straight. Leave the flat surfaces (top and bottom) rough sawn. The rough texture left by the saw improves the mechanical bonding characteristics of the strip. The remaining marks on the exposed surfaces will be sanded smooth after the new deck has been laid.

If you plan to mill your own stock, select a plank width that makes the most efficient use of the raw stock. Teak is generally available in 2" (50 mm)-thick, rough-sawn planks—you should get close to a $1\frac{3}{4}$ " (45 mm) finished dimension from these planks. Saw the stock so that the strips will be edge-grained (Figure 6-3). This will minimize expansion and contraction of the wood and make a more attractive, even-wearing surface than will slab-grained strips. Select wood that is well seasoned.

Make all necessary repairs to the sole or deck structure before applying teak veneer. See Section 6.1 to repair a plywood deck. See Section 5 to repair a cored fiberglass laminate deck. Install a teak deck as follows:

1. Plan the location and pattern for the layout of the teak strips (Figure 6-4). Cut the strips to fit and mark them for reference as necessary. Mask off the application area and cover the surrounding area with plastic for protection against spills.
2. Prepare the bonding surfaces. Wipe the bonding surfaces of the boat with a wax and silicone remover or solvent and dry with a paper towel. Grind non-skid areas flat and abrade smooth surfaces with 50-grit sandpaper. Remove sanding dust.
If any of the bonding surfaces of the teak are smooth, sand them with 50-grit sandpaper. Wipe the bonding surfaces of the teak strips, using paper towels with acetone, lacquer thinner or isopropyl alcohol 30 minutes before bonding. This will help to improve epoxy penetration by removing some of the natural oil from the surface of the teak.
3. Place the first set of teak strips in the desired location and mark the bonding area and reference location points on the strips and deck. Place only the number of strips that can be applied during the open time of a batch of epoxy. The open time will vary with the resin/hardener combination you are using and the ambient temperature. Begin with a small area or number of strips.
4. Wet out the bonding surface of the first set of teak strips and the corresponding bonding area of the deck. Remember to solvent wipe the bonding surfaces of the teak 30 minutes before the wet-out.

Prepare an appropriate sized mixture of G/flex 655 epoxy then add enough 502 Black Pigment (about 3%) or 423 Graphite Powder (about 5%) to turn the mixture an opaque black color. Apply enough thickened epoxy to the deck to bridge gaps between the strips and the deck and to squeeze up and fill the gap between the planks. A 809 Notched Spreader works well to apply an even layer over the deck. Be sure to leave reference marks uncovered.

5. Position the first set of strips on the deck. Use the reference marks as necessary.
6. Clamp the strips in place with #10 sheet metal screws and large washers. Place the screws and washers between the strips, 8" (20 cm) apart. Each row of screws will clamp the edges of two adjoining planks and act as spacers (Figure 6-5, left). Coat the screws and washers with a mold release (cooking nonstick spray) or place a small sheet of plastic under the washers to prevent bonding. Washers may also be cut from stiff plastic, thin wood lath covered with plastic, or similar stock with holes drilled for the screws. Push adjoining strips tight against the screws before tightening the screws completely. Tighten the screws enough to hold the strips firmly and force some of the epoxy mixture to squeeze up between the strips.

Fill any voids between the planks with the G/flex 655 and 502 Black Pigment or 423 Graphite mixture and smooth the excess epoxy flush with the surface of the teak strips.

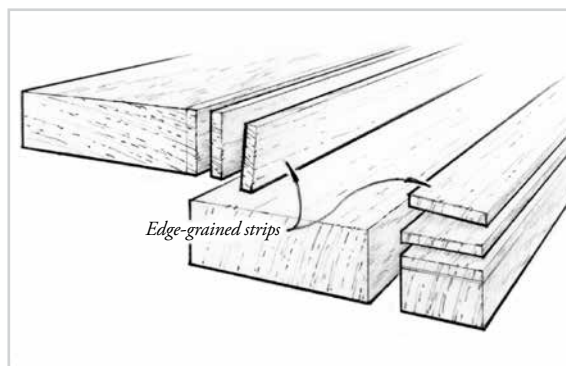

Figure 6-3 Alternate methods for cutting edge-grained deck strips from rough-sawn teak planks.

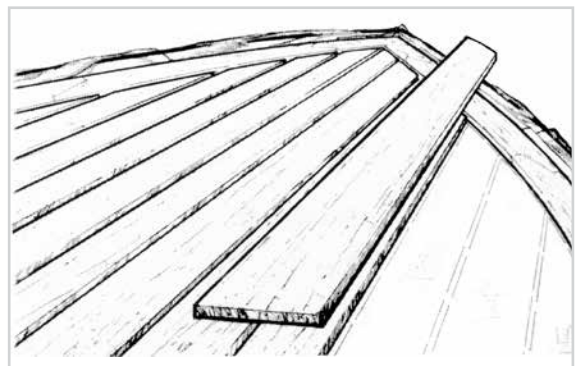

Figure 6-4 Cut and fit the teak strips. Mask off and protect surrounding surfaces.

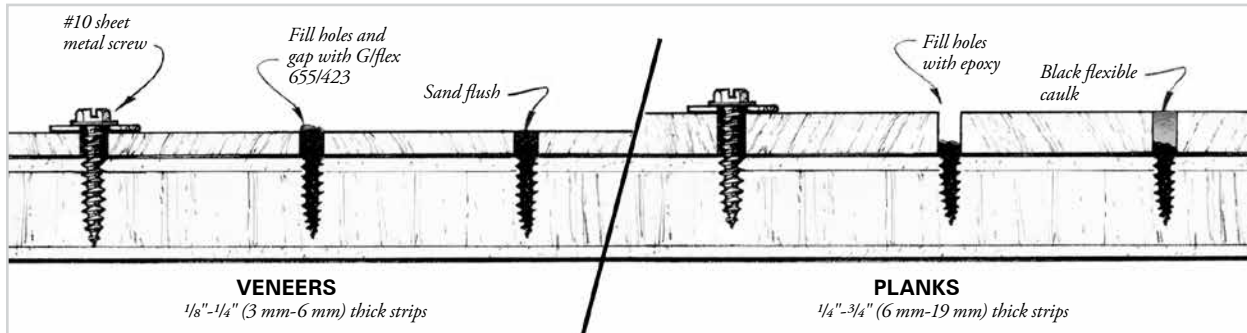

Figure 6-5 Teak veneer and teak plank installations cross section. Clamp strips in position with #10 sheet metal screws and washers. Sand the surface of veneers and planks after the epoxy cures thoroughly. Caulk the gap between planks after sanding.

Scrape up excess epoxy around the outside edges of the set of strips before the epoxy begins to gel.

7. Bond the remaining strips in place, several at a time, following the same procedure. Adjust the number of strips or size of the batch of epoxy as necessary. Allow the epoxy to cure thoroughly before removing clamps.
8. Remove the screws and washers within 24 hours. Tighten the screw slightly (5°) before backing it out. If you have difficulty removing a screw, heat the head with a soldering gun's cutter tip. While the screw is still hot, try to unscrew it again. Repeat until you are successful.
9. Fill the screw holes with G/flex 655 and 502 Black Pigment or 423 Graphite mixture. A syringe loaded with the mixture will speed the process. If the screws penetrated a panel, seal the back of the hole with duct tape before filling the hole.
10. Sand to level the surface and remove saw marks from the teak surface. Use a belt sander or disc sander with 50-grit sandpaper for the initial sanding. A commercial floor sander works well for large decks. Finish with 80-grit then 120-grit sandpaper. The teak surface may be left natural or finished with a marine-grade teak oil, marine varnish or WEST SYSTEM 105 Resin/207 Hardener and a high quality two-part polyurethane varnish.

6.2.2 Installing teak planks

An alternative method allows the use of teak strips up to $\frac{3}{4}$ " (19 mm) thick. The top surface of a thick plank will expand and contract much more than the bottom, bonded surface of the plank, because the moisture content varies more at the top surface. Because of this expansion differential, a more yielding material such as flexible caulk is more appropriate for the upper portion of these joints. This method uses epoxy to bond planks to the substrate, but uses a flexible caulk to fill the gap between planks.

The steps for preparing and placing teak planks is the same as for installing veneers. Instead of filling the gap between strips with epoxy—as the planks are clamped down, clean excess epoxy out of the gap. Epoxy should fill no more than $\frac{1}{3}$ of the height of the plank (Figure 6-5, right). After the epoxy cures, remove the clamping screws and fill the fastener holes with epoxy as with the veneer method. Prepare the sides of the teak planks for bonding—they should be clean, dry and sanded. Mask off the gaps to make caulking neater. Fill the remaining gap between planks with a flexible caulk such as polysulfide. Sand the deck smooth after the caulk has cured.

7 Installing Hardware

Hardware attachment is a critical and often overlooked element in a boat's structure. Over time, high-loads and fatigue can cause hardware fasteners to loosen, not only reducing the load carrying ability of the hardware, but creating a source for leaks into the laminate. Leaks at hardware locations are the most common cause of skin delamination and core damage. Often, the first indication of loose hardware is an area of delaminated deck nearby. This section provides procedures for the repair of hardware installations with the objective of improving the load carrying ability of the hardware, and eliminating hardware movement and leaks.

Standard hardware installations

Many factory hardware installations are inadequate for the loads on the hardware, which is evident if the installation is loose or leaking. Hardware items attached with multiple fasteners must have all of the mounting holes drilled precisely or the fasteners will not share the load equally. If not drilled accurately, the hole with the most highly-loaded fastener will elongate as the hardware is continually loaded. The hardware eventually becomes loose and the gap provides an entrance point for moisture.

The typical approach to this problem is to accept the hardware movement and to bed the hardware item in an elastic sealant material. A variety of sealants are used for this purpose, all with a very high elongation capability (usually 200% or greater) and good adhesive qualities. Unfortunately, high elongation means low load-carrying capability and the inability to prevent hardware from moving when subjected to any significant load. The sealant's job is limited to preventing water leakage. However, over time, continual hardware movement will break down sealant material, eventually allowing moisture to pass through into the laminate.

Improved hardware installations

To overcome the problems associated with hardware installations, West System has developed an approach called hardware bonding. The principle of hardware bonding is to eliminate all hardware movement by distributing the high, single-point loads of the hardware to as large an area of deck or hull laminate as possible. This is accomplished in two ways—by bonding all fasteners into the laminate to equalize their load carrying ability and by bonding the contact surface of the hardware item to the laminate surface. Proper hardware bonding techniques can dramatically improve the hardware's load-carrying capacity over hardware installed by standard methods. Bonded hardware becomes an integral part of a deck or hull and can perform long term without leak-causing movement.

In saltwater applications, our experience has been that bonded hardware and fasteners show excellent resistance to corrosion attack. Where fasteners are vulnerable to flexure and saltwater attack (i.e., hollow or bridged traveler tracks, bonded U-bolts or solitary eyebolts) a small silicone sealant fillet covering the joint between the cured epoxy and the fastener will protect against moisture and salt intrusion. Of course, any exposed metal surface will be subject to the effects of saltwater corrosion, therefore proper maintenance and cleaning procedures must be practiced.

7.1 Bonding fasteners

Bonding fasteners with epoxy is the most important part of hardware bonding and improving hardware load capacity. The techniques for bonding fasteners vary depending on the type of fastener, the substrate, the loads on the fastener, and any existing damage to the substrate. This section describes simple fastener bonding for several situations. Section 7.2 describes more advanced fastener bonding in combination hardware (base) bonding.

Basic fastener bonding

Normal vibration can cause hardware fasteners to loosen as fibers around the fasteners are fractured and compressed. A simple countermeasure is to:

1. Remove the loose fastener.
2. Clean the threaded hole with a cotton swab and solvent (such as acetone) to remove any wax, oil or other contaminate.
3. Wet out the hole with epoxy using a syringe, pipe cleaner or cotton swab.
4. Reinstall the fastener. The fastener can be waxed for easier removal. This technique will help retain the strength of the connection and prevent moisture penetration. Fastener connections that have lost strength or were under-engineered require a more extensive repair.

7.1.1 Bonding fasteners to non-cored panels

Hardware fasteners that are screwed to a non-cored panel without additional blocking rely entirely on the skin for holding power. If the fastener hole is stripped, the skin will provide little holding power for clamping or the hardware loads.

Panels with back access

Blocking, bonded to the back of the panel, will not only provide the holding power for clamping, but greatly increase the load carrying capability of the hardware. If you have access to the back of the panel, bond a plywood block to the inner side of the panel. The block should be thicker than the length of fasteners and cover an area beyond the perimeter of the fasteners. The larger the block, the greater the load transfer area. With the block in place, follow the basic fastener bonding procedure described above.

Panels without back access

If a small fastener hole in a non-cored panel is stripped and you don't have access to the back of the panel, the hole can be plugged to regain some holding power. This technique is not recommended for high load applications.

1. Enlarge the stripped holes to at least $\frac{1}{4}$ " (6 mm) diameter or about twice the screw diameter.
2. Cut a cylinder or cube of flexible, open-cell foam with a cross section about twice the hole diameter.
3. Saturate the foam with epoxy and insert the foam into the hole. Work the foam through the hole with a small stick or nail. Allow the epoxy to cure thoroughly with most of the foam volume on the inside of the hole (Figure 7-1).
4. Grind the foam flush with the surface and re-drill a pilot hole in the foam.
5. Wet out the pilot hole thoroughly with epoxy before reinstalling the hardware. The foam density, the depth of the plug, the amount of foam expansion in back of the hole, and the epoxy content of the foam all affect the holding power of the plug.

7.2 Bonding fasteners and hardware

Hardware can vary by size, type, and number of fasteners, and the size and direction of the load on the hardware. The panel may be cored or a single skin, with and often without

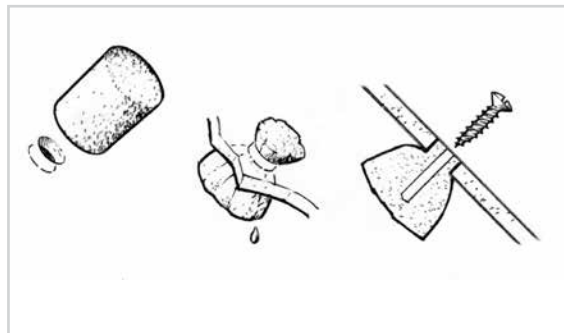

Figure 7-1 Work the open-cell foam through the hole with a small stick or nail and allow the epoxy to cure thoroughly. Grind the foam flush with the surface and re-drill a pilot hole in the foam.

blocking behind it. The hardware fasteners may be through-bolted with washers or a backer plate, or screwed to the skin and blocking, or simply to a single skin.

The following procedures describe repairs for through-bolted fasteners and for fasteners that do not pass through the panel. These repairs combine techniques for advanced fastener bonding and techniques for bonding the hardware base. Through-bolted fasteners are used on larger or more heavily loaded hardware. Fasteners that are screwed to the skin and core or blocking carry less load and should be used for lighter hardware. If the hardware is screwed to a cored or non-cored panel, follow the procedure in Section 7.2.2.

Bonding to metal—Bonding the metal hardware base to the substrate provides additional load transfer to the substrate. Proper surface preparation, beginning with thorough sanding, is crucial to getting a good mechanical bond to metal.

7.2.1 Through-bolted fasteners—cored panels

Hardware bolted through a balsa or foam cored panel can be over-tightened or loaded enough to crush the skins and core material. Replacing the core with an epoxy mixture in the immediate area of the hardware installation will allow the panel to withstand the compression loads exerted by the fitting's through-bolts and nuts. Replacing a portion of the core with epoxy will also provide for better load distribution and protect the core from moisture.

It will be helpful to have a helper on the opposite side of the panel to handle nuts, backing plates and washers, and to control excess epoxy. If the hardware is through-bolted to a cored panel, prepare the panel and bond the hardware for increased load transfer as follows:

1. Remove the loose hardware and thoroughly clean dirt, paint, sealants, etc., from the hardware and the deck or hull surface. Wipe both surfaces with solvent to remove any residue or contaminants. Inspect for delamination or core damage and make the necessary core repairs before reattaching hardware (see Section 5). Cover interior areas below the hardware location with plastic for protection from spills and dirt.
2. Clean out the fastener holes and remove a portion of the core around the hole. Re-drill holes with an oversized bit or enlarge holes with a round file to increase bonding area. Drill through the outer skin and core only. Remove about ½" (12 mm) of core material around the hole with a bent nail or an Allen wrench chucked into a drill motor (Figure 7-2). The spinning nail or Allen wrench will pulverize the core material without damaging the skins, provided you are careful.
3. Seal the underside of the holes with duct tape and fill the holes completely with Six10 Epoxy Adhesive or a 105 Epoxy/406 or 404 filler thickened to the consistency of mayonnaise. Allow the mixture to cure thoroughly.
4. Temporarily place the hardware item in position and trace the outline of the base and the fastener holes with a pencil. Re-drill slightly oversized fastener holes through the cured epoxy (Figure 7-3).
5. Mask off the outside of the marked area and cover the area beyond the tape with plastic sheeting for protection from spills.
6. Thoroughly sand the surface within the masked area with coarse sandpaper to provide good mechanical keying for bonding.
Sand the contact surface of the hardware item with coarse sandpaper to expose fresh metal. Mask off the area not to be bonded on the hardware item to prevent contamination. Re-tape the underside of the fastener holes to contain the epoxy.
7. Wet-out the deck surface, the inside of the fastener holes, the fastener threads and the sanded contact surface of the hardware with epoxy. While the hardware contact surface is still wet, abrade the coated surface with coarse sandpaper, working the epoxy into the metal surface. This technique exposes fresh metal directly to the epoxy without any air contact and the possibility of oxidation. Insert the fasteners in the hardware.
8. Apply Six10 Epoxy Adhesive or a 105 Resin based epoxy thickened with 404 or 406 filler to a peanut butter consistency, to one of the bonding surfaces. Apply enough of the mixture to bridge any gaps between the two surfaces. Apply the thickened mixture to both the fastener threads and the inside of the fastener holes.

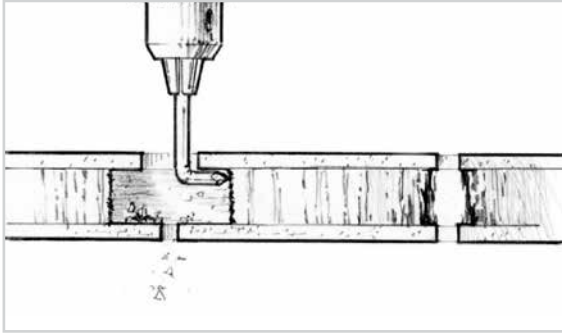

Figure 7-2 Remove about 1/2" (12 mm) of core material around the hole with a bent nail or an Allen wrench chucked into a drill motor.

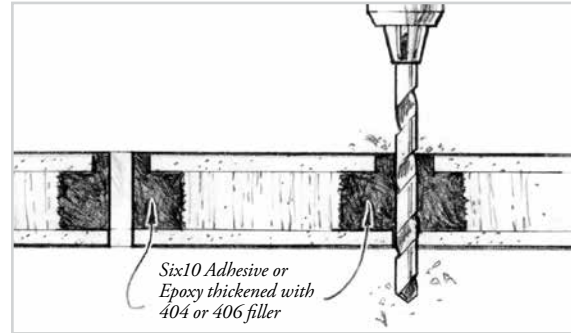

Figure 7-3 Re-drill slightly oversized fastener holes through the cured epoxy.

Apply enough thickened epoxy to the contact surface of the backer plate to bridge gaps between the backer and the inner surface of the panel. Since the backer plate is held in compression, its bond to the inner side of the panel is not critical. However, filling the gaps between the surfaces with epoxy will provide uniform bearing against the panel.

9. Place the hardware item in position on the surface, carefully inserting the bolts through the fastener hole. Have your helper on the inside of the panel cut an "X" through the tape over the fastener holes and guide the bolts through the slits in the tape. The tight fit of the tape around the bolts should keep most of the epoxy from squeezing out of the holes. Remove the tape after the bolts are in position.
10. Place the backing plate over the bolts in position against the inner side of the panel. Tighten the nuts until epoxy begins to squeeze from the sides of the hardware item and backing plate (Figure 7-4). Do not over-tighten the fasteners. Clean away any squeezed out epoxy mixture with a chisel-shaped mixing stick and remove the masking before the epoxy begins to gel. Tighten the nuts completely after the epoxy cures thoroughly. Allow the epoxy to cure at least 24 hours before applying load to the hardware. Allow more time in cool weather.

You may wish to upgrade a hardware attachment that was screwed into the laminate or through-bolted with washers instead of a backing plate. Often, adequate backing plates were not installed by the original manufacturer, causing hardware items to over-stress a localized area. You can increase the load carrying ability of the hardware and reduce stress concentrations by fabricating a plywood or metal backer and installing it as described above.

7.2.2 Screw type fasteners

If hardware is screwed to a cored or non-cored panel without additional blocking, the fasteners rely primarily on the skin for holding power. Bonding the fasteners in epoxy can greatly improve holding power by increasing the load transfer area around the fastener. If the hardware is screwed to a cored panel or a non-cored panel with blocking, prepare the panel and bond the hardware for increased load transfer as follows:

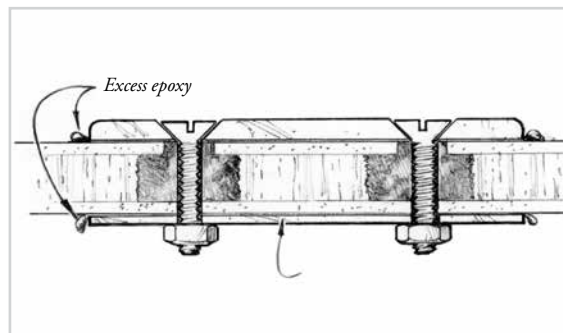

Figure 7-4 Tighten the nuts until epoxy begins to squeeze from the sides of hardware item and backing plate.

1. Remove the loose hardware and thoroughly clean dirt, paint, sealants, etc., from the hardware and the deck or hull surface. Using plain, white paper towels, wipe both surfaces with solvent to remove any residue or contaminants. If the panel is cored, inspect for delamination or core damage and make the necessary core repairs before reattaching hardware (see Section 5).
2. Drill an oversized hole around each existing fastener hole to increase the amount of skin and core area that the epoxy around the fastener can bond to. This may be much larger than the fastener—twice the fastener diameter, for example. If the fastener still has holding power at the bottom of the hole, drill the oversized hole $\frac{2}{3}$ to $\frac{3}{4}$ the depth of the fastener. This will leave material for the bottom threads of the fastener to bite into and provide some clamping pressure when the hardware is bonded in position (Figure 7-5, left).

In some cases (if the hardware is being mounted to a horizontal surface, for example) gravity or weight can provide enough clamping pressure to hold the hardware and the fasteners in position. In this case, drill the oversized hole to the full length of the fastener.

If it's necessary for the fasteners to provide clamping pressure (on vertical surfaces, for example) and the existing hole is stripped and has no holding power, drill the oversized hole to the full length of the fastener and fill the hole at least $\frac{1}{4}$ to $\frac{2}{3}$ full with epoxy. If the surface is vertical or overhead, partially fill the hole with Six10 Epoxy Adhesive or apply a coat of unthickened epoxy then 105 Resin based epoxy thickened with 404 or 406 to a non-sagging consistency. After the epoxy has cured, drill a standard sized pilot hole in the epoxy to provide enough holding power for the fastener to clamp the hardware (Figure 7-5, right). Place the hardware in position temporarily to locate the proper pilot hole locations.

If the loose hardware was mounted to a non-cored (single-skin) panel without blocking, see Section 7.1.1.

3. Temporarily place the hardware item in position and trace the outline of the base and the fastener holes with a pencil.
4. Mask off the outside of the marked area and cover the area beyond the tape with plastic sheeting for protection from spills.
5. Thoroughly sand the surface within the masked area with coarse sandpaper to provide good mechanical keying for bonding. Sand the contact surface of the hardware item with coarse sandpaper to expose fresh metal. Mask off the area not to be bonded on the hardware item to prevent contamination.
6. Wet-out the deck surface, the inside of the fastener holes, the fastener threads and the sanded contact surface of the hardware with epoxy. While the hardware contact surface is still wet, abrade the coated surface with coarse sandpaper, working the epoxy into the metal surface. This technique exposes fresh metal directly to the epoxy without any air contact and the possibility of oxidation.
7. Apply Six10 Epoxy Adhesive or a 105 Resin based epoxy thickened with 404 or 406 filler to a peanut butter consistency, to one of the bonding surfaces. Apply enough of the mixture to bridge any gaps between the two surfaces. Inject or use a mixing stick to fill the fastener's holes with the thickened mixture. Use enough mixture so there will be no voids in the hole after inserting the fastener. Coat the fastener threads with the thickened mixture to minimize air voids on threads.
8. Place the hardware item in position. Insert and tighten the fasteners until a small amount of epoxy squeezes out of the joint. Do not over tighten (Figure 7-6).
If you are not relying on the screws to clamp the hardware in position, brace or weight the hardware until a small amount of epoxy squeezes from the joint. Be sure the fasteners are pushed tight against the hardware.
9. Clean the excess epoxy mixture that has squeezed out of the joint and remove the masking before the epoxy begins to gel.
10. Allow the epoxy to cure at least 24 hours before applying a load to the hardware. Allow more time in cool weather.

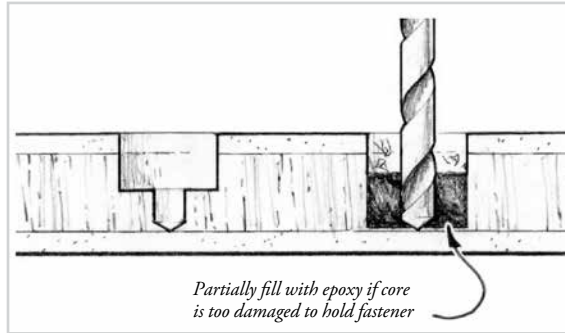

Figure 7-5 Drill an oversized hole around each existing fastener hole to increase the fastener's bonding area and a standard sized pilot hole at the bottom of the oversized hole to provide holding power for the fastener to clamp the hardware.

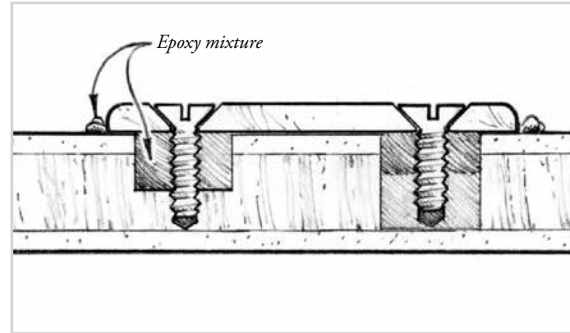

Figure 7-6 Tighten the fasteners until a small amount of epoxy squeezes out of the joint.

7.3 Casting epoxy bases for hardware

Occasionally, fittings must be set at specific angles to the hull or deck surfaces. Downrigger bases, lifeline stanchions, winches and turning blocks are all good examples. Traditionally, hand-carved, wedge-shaped shims have been used to achieve the proper angles with such fittings. Unfortunately, wooden shims require a great deal of time and carpentry skill. Hardware casting can save time and is easy to do—more importantly, it can result in a stronger, waterproof base. Cast the hardware at an angle to the surface as follows:

1. Prepare the bonding surfaces. Clean the substrate and hardware bonding surfaces with solvent to remove any contaminants. Sand the deck with 50-grit sandpaper. Apply a release agent, such as an automobile wax or a nonstick cooking spray, to the base of the hardware.
2. Position the hardware. Mark the outline of the hardware and shim it to its desired angle. Mark the shim locations. Often one edge of the fitting will rest on the deck and become the zero point for the required angle.
3. Wet out the substrate (deck) surface with resin/hardener mixture except for the shim locations.
4. Cast epoxy supports under the hardware (Figure 7-7a). Prepare a mixture of 105 Epoxy/404 filler, thickened to a peanut butter consistency. (404 filler is recommended in thicker applications where exotherm may occur. In thicker applications and in warm temperatures 206 Slow or 209 Extra Slow Hardener may be used to reduce the possibility of exotherm. In applications under ½" (12 mm)-thick, Six10 Epoxy Adhesive or 105 Epoxy/406 filler may be used.) Use the mixing stick to place three portions of the mixture within the hardware outline, evenly spaced around the perimeter. Use enough of the mixture and pile the mixture high enough to contact the base of the hardware when it is shimmed in its proper position. When cured, the epoxy supports will take the place of the temporary shims. Set the fitting in place with the temporary shims holding the hardware at the proper height and angle. The bottom of the hardware should contact all three epoxy supports. Allow the epoxy supports to cure thoroughly.
5. Tap the hardware with a mallet to break it loose and remove the temporary shims. Mask off the area around the fitting with duct tape and plastic in case of accidental epoxy spills.
6. Prepare the deck and hardware for casting the base. Wash and sand the cured epoxy in the deck base area. Reapply mold release to the hardware base. At this time, mask off areas of the hardware that you don't want to come in contact with the epoxy. You may also find it helpful to place small pieces of tape over the holes in the hardware item to prevent the epoxy mixture from oozing up through them when the piece is repositioned.
7. Apply enough 105 Epoxy/404 mixture, thickened to a peanut butter consistency, to fill the entire base area. (Six10 Epoxy Adhesive or 105 Epoxy/406 filler may be used in applications under ½" (12 mm)-thick.) Build up the mixture slightly taller than the base supports, roughly forming the shape of the base. Fill all voids around the epoxy supports.
8. Reset the hardware in its proper location. Slowly press it into the proper position on top of the cast epoxy supports. Allow excess epoxy mixture to squeeze out of the gap between

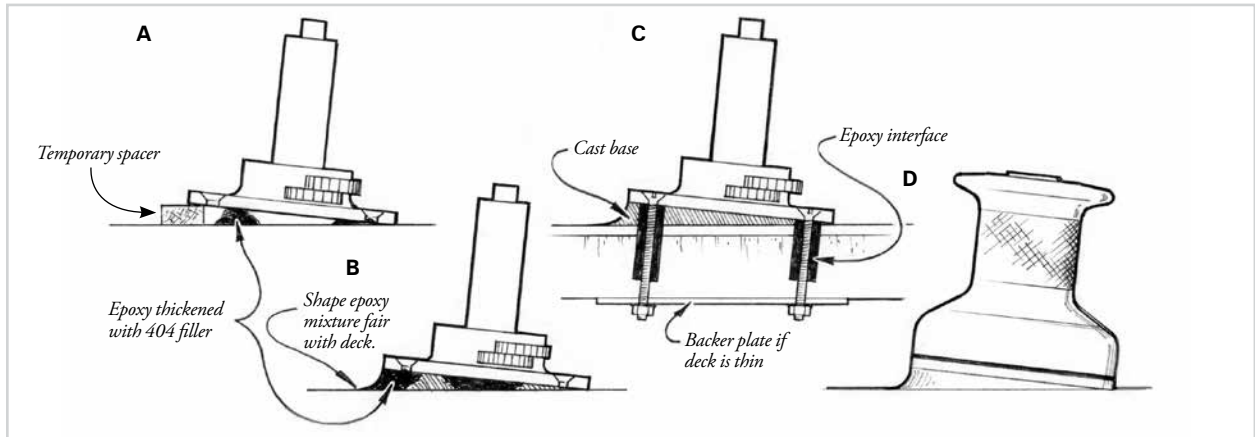

Figure 7-7 Hardware casting is a variation of hardware bonding for fittings that must be mounted at specific angles to hull or deck surfaces or mounted to curved or uneven surfaces.

the base of the hardware and the deck. Sculpt the squeezed out mixture into the desired shape (Figure 7-7b). A standard fillet works well in this situation (Section 16.4.3). Add extra mixture if necessary for shaping or to fill any voids. Remove any excess epoxy before it cures. Allow the epoxy to cure thoroughly.

9. Tap the hardware with a mallet to remove it from the base. Clean the bottom of the hardware and the top of the cast base with solvent to remove the mold release. Sand both bonding surfaces with 50-grit paper.
10. Sand the cast base to the desired final finish. Begin with 50-grit sandpaper or a file if the base is extremely irregular. Finish with 80-grit sandpaper.
11. Bond the hardware to the cast base using the hardware bonding procedure in Section 7.1.1 (Figure 7-7c). Drill oversized and standard pilot holes for the fasteners through the cast base. Allow to cure at least 24 hours before reassembling or applying loads to the hardware. Allow more time in cool weather. Apply three coats of resin/hardener mixture to the base before final finishing.

7.4 Making fasteners removable

Testing at Gougeon Brothers, Inc. has shown that with bonded fasteners (screws, bolts, threaded rods, etc.), the adhesive bond to the metal is not as important as the “keying” between the epoxy and the threads of the fastener. This factor allows the builder to coat the fastener with a thin film of mold release before bonding to permit easy fastener removal after the epoxy cures.

Fatigue tests of bonded threaded rods with and without a thin coating of mold release show only a 4–10% reduction in the overall fatigue strength of the fastener with mold release. A thin film mold release will yield a more predictable performance than a thick film. Mold release may include paste wax, nonstick cooking spray, silicone spray or hair spray. While the reduction in strength of the fastener treated with mold release is slight, it should be taken into account when calculating hardware loads. We recommend adhesive bonding to all hardware and fasteners rather than the use of mold release whenever possible.

7.5 Removing bonded hardware

Occasionally it is necessary to remove bonded hardware items. At temperatures above 150°F (66°C), cured epoxy begins to lose its physical properties; the resin softens and its bonding capacity is reduced considerably. You can use this characteristic to your advantage when you would like to remove a piece of bonded hardware.

52 Installing Hardware

1. Remove all fasteners. If you used a release agent on them when you bonded the piece in place, they should come loose without too much difficulty. If the fasteners were bonded in, it will be necessary to apply heat to them, using a soldering iron. The epoxy around the fastener will soften enough to loosen the fastener when enough heat is conducted down the fastener.
2. Heat the fitting briefly with a propane torch. Protect the area around the fitting from heat damage by covering with water-soaked plywood. Allow the heat to conduct through the base of the hardware. A sharp rap with a mallet should be enough to dislodge the hardware. If the fitting doesn't break loose easily the first time, don't force it. Heat it a second time with the torch and try again.
3. Replace the hardware by following the procedures in Section 7.1.1. Re-drill the fastener holes in the existing epoxy as you would for a new installation.

8 Repairing Keels and Rudders

The thin foil shape that allows many keels and rudders to perform efficiently under water also makes them vulnerable to damage, especially from grounding. This section provides procedures to repair common problems of keels and rudders.

Modern, self-righting sailboats have either internal or external ballast keels. An external ballast keel is a foil shaped iron or lead casting, bolted to the outside of the hull. The keel bolts pass through the skin into the hull structure. An internal ballast keel involves placing the lead casting into a molded fiberglass hull cavity. The keel's outer foil shape is an extension of the hull's fiberglass skin surrounding a cast lead core.

8.1 Repairing internal ballast keels

Internally mounted ballast offers some structural advantages over external ballast, but presents some potential problems. When a boat with internal ballast is heavily grounded, the fiberglass skin takes the brunt of the collision. Unlike lead, the fiberglass laminate is not malleable, so repairs can become more complicated. Further, due to the difficulty builders encounter in trying to mate the cast lead ballast with the inside of the laminated keel pocket, irregularities and voids often occur between the lead and the fiberglass laminate. If moisture finds its way into these voids, additional delamination can occur, particularly in areas where freezing temperatures can cause expanding ice to further wedge the skin from the ballast.

Although the fiberglass laminate of the keel is generally much thicker than the hull and deck laminate, the procedure for the skin repair is the same as described in Section 4. Repair grounding damage to an internally ballasted keel as follows:

1. Remove all loose and damaged material to expose solid laminate in the damaged area and, if necessary, expose the lead core. Grind the edge of the laminate to a circular or oval shape and bevel the edge to a minimum 12-to-1 slope to provide a good bonding surface for the repair patch. Wear a dust mask!
2. Inspect for any voids and moisture between the laminate and the lead ballast. Tapping with a small hammer may help to reveal voids. Voids between the skin and the lead can be extensive and hold a lot of water. Often, water will drip or seep from a crack in the bottom of a keel for some time after a boat is pulled from the water. Drill $\frac{3}{16}$ " (5 mm) holes through the laminate in areas of suspected voids. If water can be detected, drill a pattern of holes in that area to allow the void to dry out. Apply moderate heat to the area to speed drying. Flushing the void with denatured alcohol can help to remove moisture.
3. Fill all voids between laminate and the lead ballast with a WEST SYSTEM 105 Resin based epoxy thickened with 404 or 406 filler to a catsup consistency after the laminate and voids have dried thoroughly. Inject the mixture under pressure into the void using an 807 Syringe, with the tip cut back to fit the $\frac{3}{16}$ " (5 mm) hole (Figure 8-1). If voids are extensive, use an 810 Fillable Caulking Tube with the appropriate sized drilled hole in the laminate. You may also use Six10 Epoxy Adhesive dispensed through a static mixer. Fill the remaining holes in the laminate a 105 Epoxy/404 or 406 filler mixture thickened to a mayonnaise consistency or with Six10 Epoxy Adhesive. Allow the epoxy to cure thoroughly. If necessary, use multiple applications to avoid excessive exothermic heat buildup from filling too large a void at one time.
4. Repair the lead surface if the impact was severe enough to dent or gouge the lead. Follow the procedures outlined below (Section 8.2).

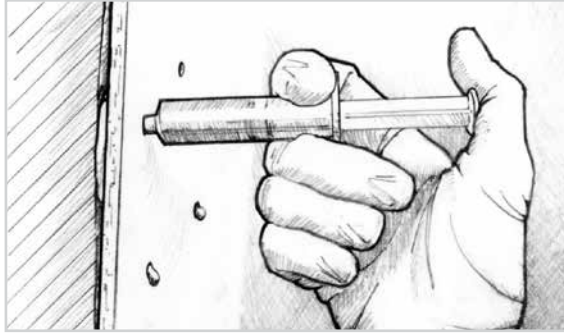

Figure 8-1 Drill $\frac{3}{16}$ " (5 mm) holes through the laminate, in areas of suspected voids. Inject the mixture into the voids.

Apply a 105 Resin based epoxy thickened with 404 or 406 filler to a mayonnaise consistency or Six10 Epoxy Adhesive, to the remaining voids in the damaged lead ballast, and a thin layer of the mixture to the beveled bonding surface of the laminate.

5. Apply a repair patch to the repair area following the procedure in Section 4.3 before the thickened epoxy layer begins to gel. Allow the patch to cure thoroughly. Sand and fair the patch and apply several coats of epoxy to the area. Wet sand the final coat after it has cured thoroughly and apply bottom paint.

8.2 Repairing external ballast keels

One of the advantages of using lead for an external keel, in addition to its high density, is its malleability. The lead will deform and thereby absorb some of the energy incurred upon impact or grounding. Its ability to deform reduces the intensity of shock loads to the hull and can prevent serious structural damage to a hull. However, the deformation of the lead keel can measurably affect overall sailing performance. Fortunately, repairing this type of damage is a relatively modest project. To repair an externally ballasted lead keel, deformed from impact or grounding, proceed as follows:

1. Be certain damaged area of the keel is accessible when the boat is hauled from the water. Dry the keel thoroughly. A heat gun or heat lamp will speed drying.
2. Remove any loose chips of lead or filling materials. Scrub the repair area with a wire brush to remove any remaining surface contamination and to expose fresh lead. Wear a dust mask!
3. Forge displaced lead toward voids with a ball-peen hammer. As the lead is deformed from an impact, it's common to find a bulge to one or both sides of a dent or gouge. Use repeated light taps to work the lead back to its original shape (Figure 8-2). Too heavy a blow will shear sections of lead. With experience, you will soon be able to gauge how much force you can use and how much lead can be moved before shearing occurs. Some alloys are more malleable and easier to forge than others.
4. Plane or file the remainder of the bulge flush after you have forged as much as is practical (Figure 8-3). For small areas, a body file works well. When greater amounts of

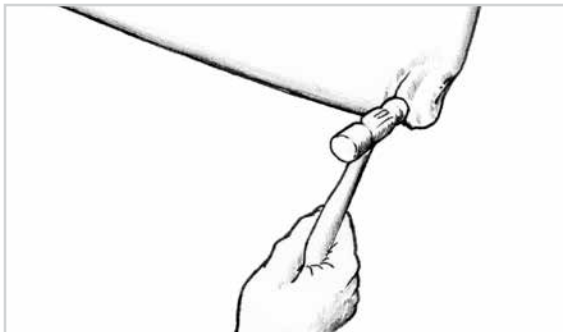

Figure 8-2 Use a ball-peen hammer, with repeated light taps to work the lead bulge back to its original shape.

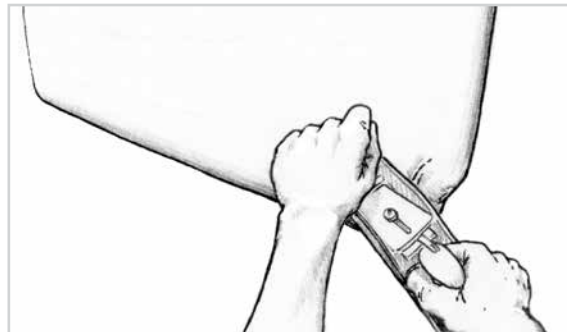

Figure 8-3 Plane or file the remainder of the bulge flush after you have forged as much as is practical.

lead must be removed, a woodworking plane is the best tool for the job. Apply a liberal coat of petroleum jelly to the lead surface. Adjust the plane's blade for a medium cut, and be certain the blade is sharp. Thoroughly clean the lead of any remaining petroleum jelly with solvent after the bulge has been faired. When the solvent has evaporated, scrub the surface vigorously with a wire brush to expose fresh lead.

5. Wet out the repair surface with epoxy. Brush the still-wet surface with a wire brush to expose fresh lead directly to the epoxy, avoiding any air contact and possibility of oxidation.
6. Fill the voids with a 105 Resin based epoxy thickened with 407 low-density filler mixture thickened to a peanut butter consistency. Trowel the mixture into the voids and shape it to match the form of the keel (Figure 8-4). If the volume of a void is larger than a golf ball, apply the mixture in several applications to avoid excessive exothermic heat buildup. Allow the mixture to cure thoroughly.
7. Sand the cured mixture to the shape of the keel with a 50-grit sanding block. Fill any remaining voids with the 105 Resin based epoxy mixture thickened with 407 filler to a peanut butter consistency. Sand again when cured and coat the entire repair area with three coats of epoxy. Complete the final sanding and application of bottom paint after the final coat has cured thoroughly.

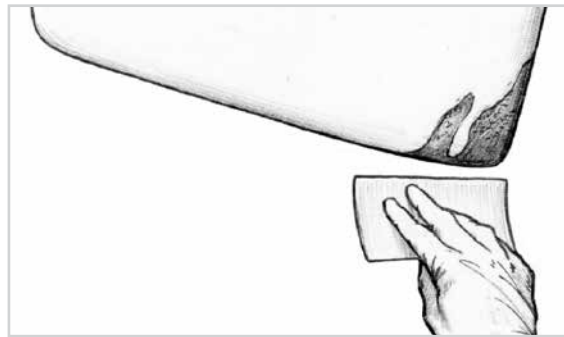

Figure 8-4 Trowel the epoxy/407 mixture into the voids and shape it to match the form of the keel.

8.3 Repairing a keel hull joint



The front of a keel repair in progress. The crack has been cleaned, widened and filled with G/flex 655.

1. Open up the joint a bit with a Dremel tool or metal cutting saw blade to expose bright metal and fiberglass laminate. Once the crack is cleaned and widened, bevel the opening generously into the surrounding fairing putty to provide a gentle transition.
2. Dispense G/flex 655 Resin and Hardener in equal amounts on a plastic sheet (or 1.2:1 by weight) and mix by folding it over itself. The pot life of G/flex is 45 minutes, so unless a large batch is mixed, there should be enough time to dispense it, although mixing multiple batches would give even more time. G/flex 655 has 32% elongation before breaking, which helps to prevent cracks from reappearing in the joint.
3. Begin applying it into the crack then follow up by filling the trough formed by the shallow bevel on both sides of the crack.
4. The repair area can be wet-sanded, dried and painted for a lasting repair.

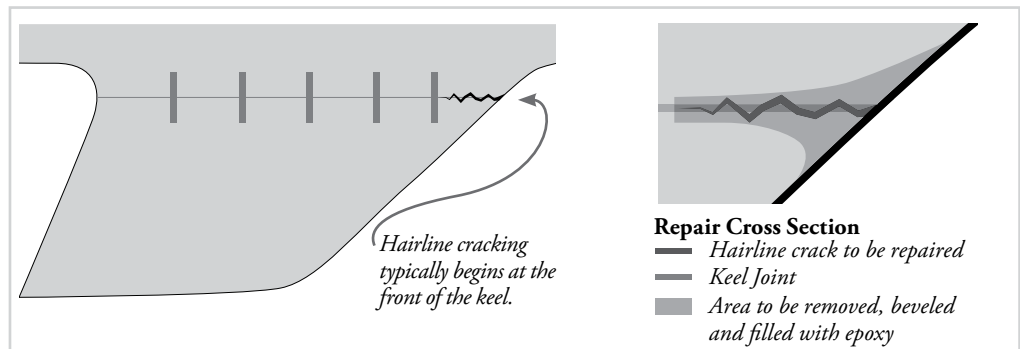

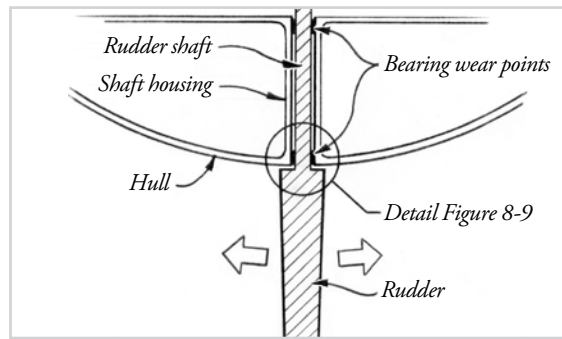

Figure 8-8 Most stock rudders simply bear on the inside of a fiberglass housing and the high loads exerted by the rudder eventually wear out the bearing surfaces.

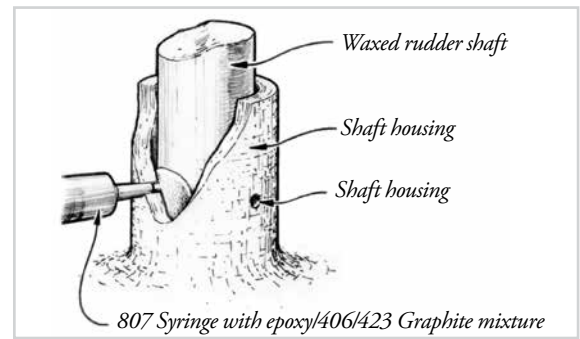

Figure 8-9 Inject enough of epoxy/406/423 mixture through the drilled $\frac{3}{16}$ " (5 mm)-diameter ports to form a $\frac{3}{4}$ "–1" diameter pad between the shaft and housing at each port.

8.4 Repairing worn rudder bearings

Common wear points on sailboats with spade-type rudders are the bearings that support the rudder shaft. Worn bearings can result in sloppy steering and an irritating thump as the rudder shaft flops from side to side in the enlarged bearing. Worn bearings can also detract from the precise sense of feel, especially important to a helmsman if the boat is raced.

Most stock rudders simply bear on the inside of the fiberglass housing in which the metal rudder shaft turns (Figure 8-8). Some builders use Delrin™ plastic or a similar material as an insert for lower friction and better wearing performance. But the high loads exerted by the rudder eventually wear out the bearings. This section describes how to restore tight steering control by injecting a new, long-wearing epoxy/graphite bearing surface around the rudder shaft.

The amount of slop in the rudder bearings is most easily detected when the boat is out of the water. Grab the bottom of the rudder blade and wiggle it side to side. Look for excess lateral motion of the rudder blade and listen for the thump of the shaft hitting the opposite side of the bearing as the rudder is wiggled. Careful observation will show if the movement is coming from the lower, upper or both bearing points.

1. Lower the rudder from the boat and wipe the shaft with solvent to remove grease and oil. Inspect the shaft for roundness and straightness. **IMPORTANT!** If the shaft is out of round or bent, you may need to take it to a machine shop to make it true. Look for burrs, rough spots or grooves. Sand smooth any burrs or other rough spots on the shaft with emery cloth or very fine sandpaper. The smoother the surface of the shaft, the less it will abrade the bearing surface. If scores or similar flaws are too deep to sand out, fill them with a 105 Resin based epoxy thickened with 406 Colloidal Silica or Six10 Epoxy Adhesive, following the procedures for bonding to metal as discussed in Section 7.
2. Wipe the upper and lower bearing surfaces with solvent to remove all traces of grease or oil. Sand the bearing surfaces with coarse sandpaper. Drill three, equally spaced $\frac{3}{16}$ " (5 mm) diameter holes through the shaft housing (Figure 8-9) at the level of the bearing surfaces. These "ports" will permit injection of the thickened epoxy to form the new bearing surfaces. Cut the end of an 807 Syringe to wedge tightly into the $\frac{3}{16}$ " (5 mm) holes. This will allow you to inject the thickened mixture under pressure into the gap between the shaft and the bearing surface.
3. Wax the shaft surface with three coats of automotive paste wax to act as a release agent and prevent the shaft from bonding to the new bearing surface.
Replace the rudder in the boat and sight the rudder to make sure that it is vertical. The keel will serve as a good reference point. Brace the rudder to prevent movement.
4. Prepare a bearing mixture of 105 Resin/hardener and a blend of 50% 406 Colloidal Silica and 50% 423 Graphite Powder. The epoxy/406/423 mixture should have the consistency of mayonnaise to prevent running or sagging. Load the mixture into a syringe.

5. Inject enough of the material through each of the three drilled ports to create a $\frac{3}{4}$ "–1" (19 mm–25 mm) diameter pad between the shaft and the housing at each port. Be careful not to move the rudder shaft until the mixture cures thoroughly.
6. Break the shaft free by grasping the rudder blade and twisting it. If the cured bearing pads are too tight after rotating the rudder briefly (which is not typical), remove the rudder and apply a buffing compound to the rudder shaft. Reinstall the rudder and work it back and forth until it turns freely in the new bearings.

Lower the rudder once more and thoroughly clean any remaining mold release or buffing compound from the shaft and bearing surfaces. Spread a thin layer of waterproof grease on the shaft and reinstall the rudder.

This technique is useful for restoring a variety of bearing surfaces. The epoxy/406/423 Graphite mixture provides a hard, low-friction bearing surface. The durability of the bearing depends a great deal on the smoothness of the surface sliding against it.

9 The Problem of Gelcoat Blisters in Fiberglass Boats

Studies suggest that one in four boats can be expected to blister in its lifetime. As more is known about blisters and their underlying causes, it is apparent that the problem has become more widespread and runs deeper than just the outward appearance of gelcoat blisters. The extent of blister damage varies from boat to boat. It may appear as a few large isolated blisters or as thousands of small blisters covering an entire hull. In some cases, owners may be unaware that their boats are blistering or that there may be a serious destructive process taking place beneath the gelcoat.

A fiberglass boat is a laminated structure consisting of layers of various reinforcing fabrics and core materials, typically bonded together with polyester resin, and covered with an outer layer of polyester gelcoat. Blisters occur when water that has penetrated the laminate dissolves water soluble materials within the laminate and accumulates in voids or cavities below the gelcoat layer. The solution of water and water soluble materials, through the process of osmosis, attracts more water to the cavities diluting the solution. The pressure of the accumulating water enlarges the cavities to form gelcoat blisters.

When water soluble materials in a polyester resin laminate mix with moisture that has penetrated the laminate, it creates an acidic fluid. This acidic mixture can attack the polyester resin throughout the laminate, severing the chemical bonds that hold the resin matrix together, as well as the resin-to-fiber bonds. This process is known as hydrolysis. Once hydrolysis has started in a polyester hull, the hull's strength has been compromised and the potential for serious additional hydrolysis will never go away. If you own a fiberglass boat built with polyester resin, you should be aware that the potential for this problem exists, and is greater in warmer climates. The extent of damage due to hydrolysis should be included in an assessment of a boat's condition before repairs are made. Gelcoat blisters can often be repaired before the laminate is damaged by hydrolysis. Keep in mind that gelcoat blisters can be an indicator of hydrolysis, and that hydrolysis can occur without the appearance of blisters.

Hydrolyzed laminate and gelcoat blisters can be treated with WEST SYSTEM Epoxy to limit further damage and in many cases restore a hull's structural integrity. In this section we will explain the factors affecting blister formation, describe techniques for repairing blister damage and applying an epoxy barrier coating, and offer steps to help prevent future problems. Our recommendations are based on our experiences coupled with extensive laboratory and field testing since we began the formulation of quality marine epoxies in 1971.

Although WEST SYSTEM Epoxy has been used to successfully repair and protect thousands of blistered boats, it is just one of the factors contributing to a lasting repair. Thorough preparation, drying, repairing and coating, as well as preventative maintenance after the repair, are also essential for a successful repair—but do not guarantee it. Other factors beyond your control, such as the amount of water soluble materials in the laminate, the level of existing damage, and the boat's environment also affect the long term success of a blister repair.

9.1 Factors affecting blister formation

As a building material, the unsaturated polyesters used in fiberglass construction seem to be a logical choice. They offer relative ease of handling, reasonable cost and, what appears to be, an acceptable working lifetime. Unfortunately, there are other important

characteristics that we now know are working against the polyester structures which lead to problems like blistering and delamination. Many variables affect the formation of blisters including the formulation of the resin for specific applications, manufacturing quality assurance and the boat's environment.

The chemical stability and moisture permeability of the polymer resin matrix are the key items affecting the durability of the fiberglass hull.

9.1.1 Permeability

The term permeability refers to the ability of a material to permit a substance to pass through it. Polyester laminating resins and gelcoats are not waterproof; they are permeable and will allow water to migrate through the cured resins at a consistent, predictable rate. The permeability of a polymer matrix involves a number of factors.

The thickness of the gelcoat layer, the amount of air or voids in the laminate and the temperature of the laminate affect how much water can permeate the laminate. The warmer the ambient temperature, the higher the rate of permeation (Figure 9-1). An increase in temperature will boost the rate of permeation through a resin matrix by intensifying the molecular motion of both the polyester and the water. This means boats in the Caribbean are more likely to have problems than those in Lake Superior.

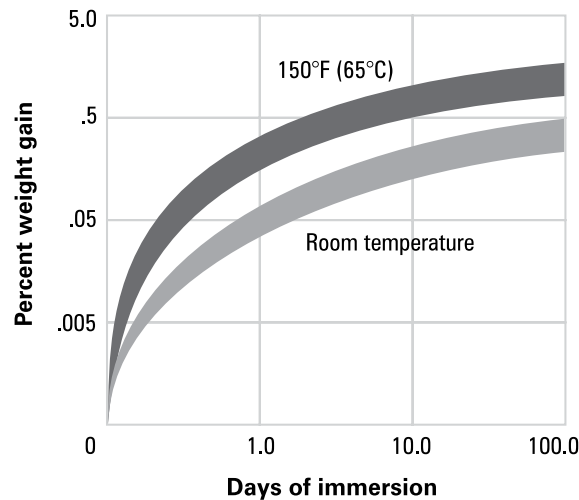

Figure 9-1 A laminate's susceptibility to moisture permeation tends to increase with higher ambient temperatures.

9.1.2 Voids

An important factor affecting blister formation is the distribution of free volume (voids) in the matrix. In any laminate, the free volume can be everything from the gaps between and within the molecules of the polymer matrix to manufacturing defects such as entrapped air bubbles, cracks or dry fabric. The cure rate, degree of cross-linking and crystallization all affect this void distribution while also contributing to the overall chemical stability of the cured polymer matrix. When water accumulates in these voids, the formation of blisters is initiated. The acidic fluid that develops may eventually begin to hydrolyze the surrounding resin. Due to manufacturing practices, voids commonly occur at the interface between the gelcoat and the laminate, explaining why a large percentage of blisters develop in this area.

9.1.3 Osmosis and Hydrolysis

Water-soluble materials, or solutes (excess glycols, acids, metal salts, etc.), trapped in voids between the laminate and the gelcoat, or within the laminate, are primarily large molecules. The laminate, meanwhile, is surrounded by relatively pure small water molecules. The small water molecules move from an area of greater concentration to an area of lesser concentration (the voids), and dissolve the solutes to form a blister fluid solution (Figure 9-2). The gelcoat and laminate act as a semi-permeable membrane. They allow the small water molecules in, but do not let the larger solution molecules out.

This one-way movement of water into the laminate is known as osmosis. More water is attracted to the voids to dilute the concentration of solutes in the solution (Figure 9-3). The blister fluid continues to accumulate and eventually creates enough hydraulic pressure to result in a blister (Figure 9-4). Research has shown that osmotic forces increase in direct proportion to the concentration of solutes in the water within the laminate.

Under the right conditions, a polymer matrix of polyester resin may degrade when exposed to water. Water in contact with the laminates unreacted resin components (glycols, organic acids, catalyst and metallic accelerator) forms an acid that can breakdown susceptible ester linkages which comprise the majority of bonds in polyester polymers. This chemical reaction is called hydrolysis. Degradation products from the hydrolyzed resin are dissolved by the water within the laminate and increase the solute concentration which promotes osmosis. Water passing into voids and resin-starved pockets within the laminate helps break down more of the polyester molecular chains, which in turn allows

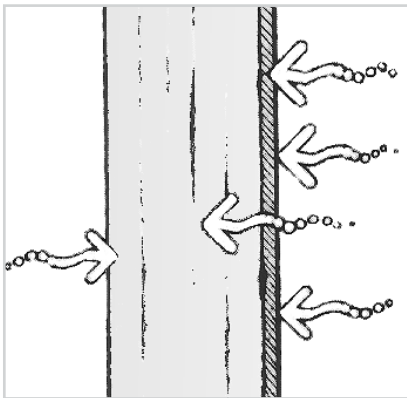

Figure 9-2 Polyester resins and gelcoats allow water molecules to migrate into the laminate and dissolve soluble materials within the laminate.

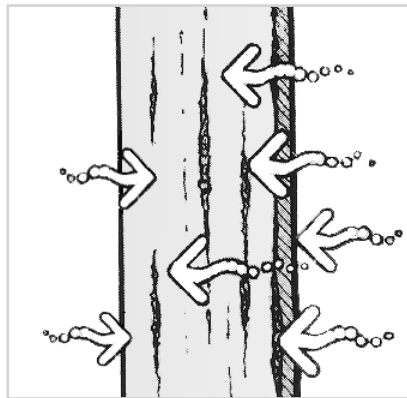

Figure 9-3 More water molecules are attracted to the voids to dilute the concentration of solutes in the blister fluid solution.

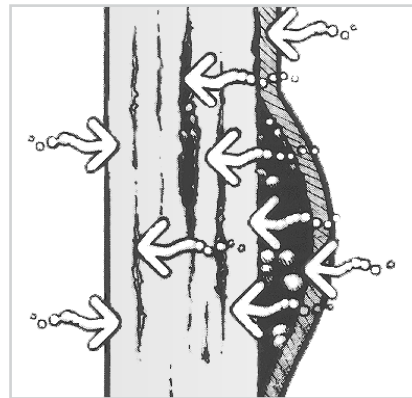

Figure 9-4 Accumulating fluid creates enough hydraulic pressure in the voids between the gelcoat and laminate to result in a gelcoat blister.

more water to pass into the laminate. The process, in effect, feeds on itself, creating more blisters and damaging more resin by hydrolysis.

The higher temperatures of tropical climates and warm damp interiors can cause increased sensitivity to degradation of the ester linkages in the polyester, an increased rate of water permeation, and can accelerate hydrolysis where it is already occurring in the laminate. Keep in mind that standing water and high humidity in the bilge (due to poor ventilation), also permeate the laminate and contribute to blister formation.

Another factor in the water transport mechanism across gelcoat membranes is surface oxidation. Sunlight with its UV degradation potential takes the gloss from gelcoats and destroys some of their water-exclusion capability.

9.1.4 Formulation variables influencing blister formation

A large number of formulation variables influence the susceptibility or resistance of cured polyester laminates to degradation and blistering. Many different types and combinations of glycols, acids and reactive diluents can be used by the resin manufacturer when developing a formulation. Each ingredient alters the basic physical characteristics of the cured resin, including hydrolytic stability, strength and elongation. The mixing process can also have an impact if it leaves improperly mixed and unreacted glycols trapped in the resin after cure.

Particular unsaturated polyester resins, accelerators and catalysts can act as blister initiators in poorly mixed or incompletely reacted matrices. Theoretically, a wide variety of additives (air-release agents, leveling additives, UV-resistant additives, surfactants, abrasion-resistant additives, fire retardants, antioxidants and co-monomers) have the potential to affect blister resistance in the cured laminate. Thixotropic agents, hydrophilic fillers, pigments, color paste vehicles, and the use of solvents as diluents can change the

sensitivity to moisture and aid in the formation of blisters. The inclusion of any moisture-sensitive materials could stimulate hydrolysis of the matrix materials and promote the osmotic pressure which causes blisters.

9.1.5 Post construction factors

Poor quality manufacturing practices, material limitations and the rigors of the boating environment can have an adverse effect on the interfacial adhesion between the polyester and fiber reinforcement in the laminate. In addition to poor wet-out during fabrication, high stress or strain in the laminate during use can cause a loss of adhesion or initiate micro-cracking at the interface. Micro-bubbles and multi-phase interfaces within the matrix (due to different cure and shrinkage rates) are all points of stress concentration and, as such, are areas vulnerable to loss of adhesion or cohesion. The resulting voids promote water migration, leading to hydrolysis and the concentration of any soluble materials in the laminate.

Although some older boats seem to be quite sound and many new boats are built to minimize blister potential, with all these variables, it may be impossible to define a laminate schedule, polyester matrix formulation and manufacturing plan to create a laminate that is totally impervious to attack.

9.2 WEST SYSTEM Epoxy for repair and coating

Moisture within the laminate is generally accepted as the common denominator in the gelcoat blister equation. It stands to reason, then, that sound measures toward combating osmotic blistering problems would be drying the laminate thoroughly, keeping the interior of the boat as dry as possible and preventing water from passing through the outside of the hull by providing a water-resistant barrier coating. The critical questions are what is the best available moisture barrier material and how should it be applied.

There are three compelling reasons to use an epoxy resin rather than a polyester resin or other materials to combat gelcoat blistering. Epoxy is more effective as a moisture barrier, has greater resistance to hydrolysis and is a better structural adhesive.

9.2.1 Choosing an effective moisture barrier

Gougeon Brothers, Inc. has developed a comprehensive test program based on U.S.D.A. Forest Service methodology which has been used for years as an established method to determine the moisture exclusion ability of a coating material. We can test identical samples treated with various coatings and application techniques to compare each coating's relative effectiveness as a moisture barrier. (The complete Moisture Exclusion Effectiveness test procedure is available upon request from Gougeon Brothers, Inc.)

As you can see from Figure 9-5, various common finishes have significantly different levels of moisture exclusion effectiveness. At the end of six weeks of exposure to 90% relative humidity at 80°F (27°C), polyester resin is functioning at 30% MEE. Polyurethane paints, on the other hand, are at nearly 40% MEE with one popular brand and 65% MEE with another.

Figure 9-5 also demonstrates that some epoxy formulations, although generally the same or slightly better than paints or varnishes, fall significantly short of a properly formulated epoxy's potential as a moisture barrier. WEST SYSTEM 105/205 and 105/206 epoxies are shown functioning at 82% and 78% MEE respectively after six weeks.

It is also significant to note that the MEE slope for WEST SYSTEM Epoxy is relatively flat at six weeks, while the low-performance epoxies, polyurethane paints and polyester resins are suffering from sharply declining curves which indicate that the MEE of these coatings will continue to deteriorate at a rapid pace.

This research has shown that WEST SYSTEM Epoxy has a much higher resistance to moisture than most other coatings. This is a critical characteristic in reducing moisture permeability through the resin matrix which could result in gelcoat blistering and/or interlaminar failure.

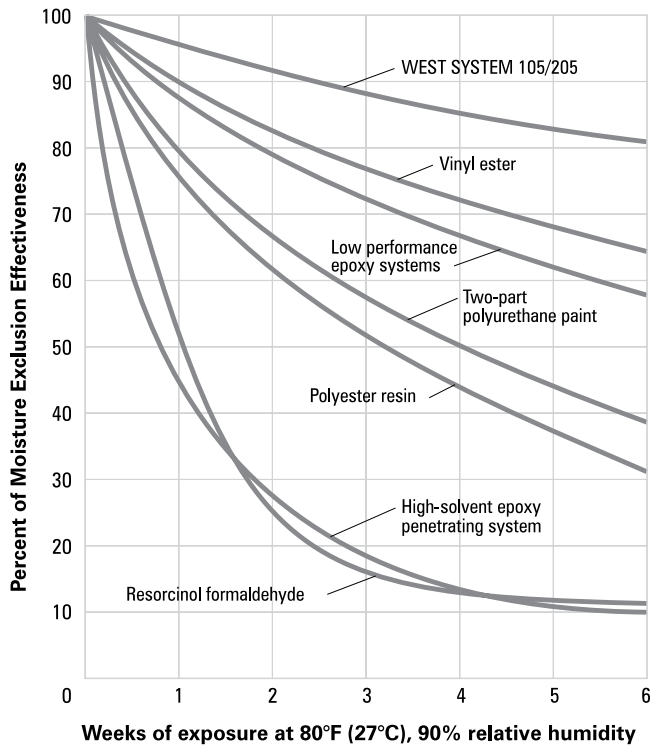

Figure 9-5 Polyester resins and gelcoats allow water molecules to migrate into the laminate and dissolve soluble materials within the laminate.

9.2.2 Hydrolysis resistance

An epoxy matrix is more resistant to hydrolysis than a polyester matrix. In general, the structure of the cured epoxy's ether linkage is more stable than the structure of the polyester's ester linkage. This means that the epoxy matrix will not be broken down by water as easily as the polyester matrix.

Epoxy has a service history proving its excellent resistance to blistering and other moisture related problems. For the custom boat builder, high-end production facility or marine repair yard, the high mechanical and chemical stability of epoxy, coupled with its excellent moisture resistance, make it an excellent choice to battle gelcoat blistering.

9.2.3 Secondary bonding

There is one other compelling reason to use an epoxy resin rather than polyester resin. To effectively repair interlaminar failure, and to repair laminate surfaces damaged due to gelcoat blistering, the repair material must be a superior structural adhesive, capable of bonding to both polyester resin and the glass fiber.

Unsaturated polyester resins perform fairly well during the construction of a structure when all of the layers of resin are applied and allowed to cure together. This type of bond is considered a primary bond. Problems can occur, however, when you try to bond polyester resin to a previously cured laminate as is necessary in blister repair applications. This type of bond is secondary or post-bonding.

WEST SYSTEM Epoxy, however, forms a superior bond with cured polyester in secondary bonding. Since the epoxy is stronger and shrinks less than polyester, the epoxy repair may actually be more durable than the original structure.

Moisture exclusion ability, hydrolysis resistance, as well as secondary bonding capability are major considerations in choosing a barrier coating. If you also consider cost, ease and practicality of application, availability, safety and access to technical assistance, WEST SYSTEM Epoxy is an excellent choice for gelcoat blister repair.

9.3 Recommendations for the repair and prevention of gelcoat blisters

1. Inspect beyond the obvious.

If you plan to barrier coat your hull after repairing blisters, we feel it is important to inspect the hull beyond the obvious blisters. Before beginning repairs, we recommend grinding through the gelcoat in several small areas. These profile inspection points, 4" to 6" in diameter, can provide valuable information on the condition of the hull laminate. If the laminate shows signs of hydrolysis, consider removing all of the gelcoat and damaged laminate. It is pointless to barrier coat over a hull that has begun to deteriorate. Just as with skin cancer, the more serious problem may lie below the surface.

2. Thoroughly dry the hull laminate.

Open up all blister cavities and excavate damaged material. Insure that the laminate, throughout the hull structure, is as dry as possible. Active drying methods, such as heating and tenting, may be used to accelerate the process.

3. Repair blisters and delamination with WEST SYSTEM® Epoxy products.

After sealing with a coat of unthickened epoxy, fill the cavities with a WEST SYSTEM Epoxy thickened with either 410 Microlight or 407 Low-Density filler. In areas with extensive blister damage, rebuild the laminate with multiple layers of glass fabric bonded with epoxy.

4. Apply barrier coat of WEST SYSTEM Epoxy with 422 Barrier Coat Additive.

Thoroughly clean all underwater surfaces and then abrade by sanding, waterblasting or sandblasting. With the hull properly prepared, apply a minimum of 20 mils (0.020") of WEST SYSTEM Epoxy to the surface. This can usually be applied in 5–6 coats. Up to 10 ten coats will provide added protection. Apply the first coat without any additives. The remaining coats should contain 422 Barrier Coat Additive, which improves the epoxy's moisture permeation resistance as well as its resistance to scratches and scuffs.

5. Provide ventilation to all parts of the hull—keep the bilge as dry as possible.

Good ventilation is a key to the longevity of your boat. Water vapor can penetrate hull laminate faster than water in liquid form. One of the best recipes for creating a high-temperature humidity chamber is to leave your poorly ventilated, tightly sealed boat in the hot sun for weeks on end. Deck temperatures can exceed 130°F (55°C), pushing cabin temperatures toward 100°F (38°C). Such a rain-forest environment provides the necessary elements for gelcoat blistering since moisture can and will pass through either side of the hull laminate. In tropical climates, where heat and humidity are an extreme problem, you may want to consider having a dehumidifier aboard. Bilge water is also an obvious source of moisture, so it is important to keep the bilge as dry as possible. We strongly recommend active ventilation in bilge areas with powered vents, especially on boats that have previously blistered.

6. Maintain the barrier coat's integrity.

Excessive sanding during haul outs, groundings, scrapes and scratches will all undermine the moisture resistance ability of your epoxy barrier coat. Keep a high-quality bottom paint on the hull. Repair scratches, dings or abrasion damage as soon as possible, re coating the repaired area with epoxy to replace the removed barrier coat.

After several haul outs, your barrier coat may have been reduced from repeated sanding. Consider removing the bottom paint and reapplying two or three coats of epoxy as described in this manual.

Do not let blisters go unchecked. As soon as possible, repair the blisters and coat with epoxy to prevent further degradation. Monitor the hull's moisture periodically. Early detection of moisture absorption can save you considerable expense and frustration in the long run.

10 Hull Preparation

This section covers the procedure for removing damaged gelcoat and laminate, and for abrading the surface to prepare a hull for drying, filling, fairing and final moisture barrier coating.

The probability for the success of this repair, and the prevention of future blistering, depends on a variety of factors, many of which are beyond your control. These include quality control during the hull's manufacture, the quality of raw materials used in construction, the age of the boat, and the climate it was exposed to. Because of factors such as these, it is impossible to absolutely rule out future blistering. You can however, improve the odds of a successful long term repair by conscientiously following the recommendations in Section 9.3.

10.1 Evaluating blister damage

If at all possible, arrange to be present when the boat is first pulled from the water. Blisters tend to shrink quite rapidly once the boat is out of the water, and can actually disappear within hours, only to reappear when the boat returns to the water. After cleaning off marine growth and dirt, scuff the bottom with 80-grit sandpaper. Blisters will show up as light spots against the darker bottom paint. Damage may range from a few large isolated blisters to an entire hull peppered with thousands of blisters no bigger than a pencil eraser. Damage may also vary considerably from one area of the hull to another. Closely inspecting the hull as soon as it's pulled will allow you to more accurately assess the nature and severity of the blistering and choose the best course of repair.

A thorough inspection includes evaluating the laminate below the gelcoat. Grind 4"–6" diameter inspection points in several places on the hull. Use a disk sander to grind shallow concave areas through the gelcoat. Wet the areas with water or alcohol. When wet, a healthy laminate looks dark and translucent. If white fibers are evident, at or below the surface, it is an indication of a manufacturing defect or that resin around the fibers has degraded and hydrolysis has taken place. If there appears to be laminate damage, grind additional profile inspection points to confirm it and determine the extent of the damage and possibly how much laminate will have to be removed.

Isolated minor blisters can be opened individually and the individual blister cavities filled and faired. This method has worked well, especially on older boats. Since older boats have survived for some time with only limited damage, it is often the case that little damage exists beyond the apparent blisters.

Extensive damage on newer boats, however, may indicate a serious material or manufacturing defect. In these cases the gelcoat should be completely removed. This eliminates the obvious damage as well as any blistering in its early stages, and it allows you to inspect the laminate for defects or damage. The gelcoat will then be replaced by the epoxy barrier coat. This option is a good idea, if time and funds allow, even if the blistering is not yet serious.

In either case, open the blisters and abrade the hull or remove the gelcoat as soon as possible. This will allow the cavities, the remaining gelcoat and the laminate to dry much more quickly. Removing the gelcoat will allow the laminate itself to dry out quicker since the moisture will not have to travel through the gelcoat. Thorough drying is an important and often rushed part of the repair. Opening blisters or removing the gelcoat quickly, with frequent washing during the drying process, will get the most out of a limited drying time.

Be sure to wear protective clothing and eye protection when opening blisters. The acidic blister fluid is frequently under as much as 200 psi of pressure. When the blister is punctured, the fluid may squirt out with surprising force.

10.2 Minor isolated blister damage

Keeping in mind that minor blistering may be a symptom of a larger problem, there are many situations where repairing isolated blisters makes sense. You may be able to repair isolated blisters and improve ventilation, and thus avoid the need for a full-blown barrier coat job. You may repair and monitor blisters for two or three years to determine the severity of your problems before decide on the most effective repair strategy. Or, you may simply want to get your boat into the water so you can go boating now.

If your hull has a manageable number of blisters or blistering is limited to a small section of the hull, this technique allows you to repair blisters in a matter of hours prior to applying bottom paint.

1. Mark the individual blisters or blister areas (by scuffing the bottom paint with 80-grit sandpaper) for future reference if you are not able to open the blisters right away, or:
2. Immediately open the blister cavities. Use a small sanding disk (such as 3M's Roloc™ 2" diameter sanding disk) with 60-grit sandpaper, chucked into a variable-speed drill (Figure 10-1). Make sure that you have removed the entire blister, including the edges of the blister dome. Complete the repair following the procedures in Section 12.

10.3 Extensive blister damage

If you've pulled the boat from the water and find yourself faced with hundreds or thousands of blisters, it may not be practical to open each blister individually. The job of filling and fairing all of the individual blister cavities also takes on monstrous proportions. Grinding, sandblasting or peeling are options that allow you to open all of the blisters and abrade the entire hull (or remove the gelcoat entirely) in one operation. Each method has advantages and disadvantages.

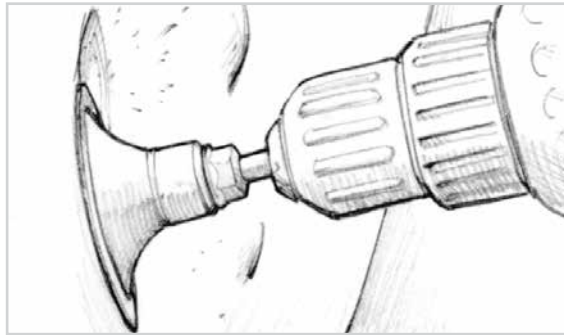

Figure 10-1 Use a small rotary tool chucked into a variable-speed drill to open the blisters.

10.3.1 Grinding

Grinding or sanding is the most common method for opening blisters and abrading the gelcoat and is often the only option for boat owners who choose to repair their own blisters. However, grinding is not a pleasant job and, depending on the skill of the operator, may leave the hull uneven and in need of extensive fairing. The operation also creates a lot of dust and a potential health hazard. The equipment required is relatively inexpensive and widely available. It includes a 1000–2000 RPM air or electric polisher, with an 8" foam sanding pad.

Grind the hull to remove bottom paint, open blisters and abrade the surface as follows:

1. Prepare the work area to protect against dust hazards, especially when bottom paint is to be removed. Check local ordinances for restrictions and follow safe waste management practices. It is a good idea to remove all thru-hull fittings.
2. Clean the hull of all marine growth and contaminants like grease or oil.
3. Grind the hull beginning with a coarse grit (24–40) to strip the bottom paint and open blisters. Hold the grinder at a low angle (nearly flat against the hull) to avoid gouges. Remove enough of the gelcoat to expose all of the blister cavities or, if the blisters are shallow, continue removing gelcoat until the surface is flush with the bottom of the

cavities. Leaving cavities in the surface will require more filling and fairing. In all cases, keep grinding until a solid, undamaged surface is exposed (Figure 10-2).

4. Grind the surface again with a finer grit (50–80) to remove the coarser grit scratches and fair the surface. If sanded fair enough, little filling and fairing will be required. For this operation, an air file or double action (DA) sander may provide more control for fairing than the disc sander. You may choose to sand through all of the gelcoat to the first layer of laminate.
5. Inspect the hull for any further damage after sanding. Sound the hull to detect any interlaminar voids. Repair any voids that are found, following the appropriate procedure in Section 12.3, before beginning the filling and fairing operation.

10.3.2 Sandblasting

Sandblasting (or water-blasting) involves much more expensive equipment which may be rented (Figure 10-3). Professional sandblasting services are available in many areas. Sandblasting will leave a generally fair but pitted surface. This method is also a potential health problem because of the airborne dust generated. Because sharp sand is blasted into the surface under air pressure, bottom paint should be removed before sandblasting. Failing to do so may result in small particles of paint or contaminants being imbedded in the laminate, a condition which may create bonding problems later on.

When using this method, be very careful not to sandblast too deeply. Do not drive gelcoat particles into the softer, underlying laminate nor remove excessive amounts of the laminate. Consider sandblasting 80 or 90% of the gelcoat away, and then finishing the process by sanding. After the gelcoat is removed, inspect the laminate for hydrolysis, delamination or other damage.



Figure 10-2 Use an electric polisher with an 8" foam sanding pad to open blister cavities or remove gelcoat.



Figure 10-3 Sandblasting is a common method of opening blisters and abrading the hull.

10.3.3 Gelcoat peeling

Gelcoat peelers are designed around an electric or hydraulic powered cutting head that shaves the gelcoat down to the appropriate depth in one pass. Peeling leaves a relatively smooth surface, which reveals flaws within the laminate better, and requires much less fairing than a ground or sandblasted surface. Peelers also allow for better waste collection than grinding or sandblasting, minimizing environmental hazards. Gelcoat peelers are relatively new technology and the service, where available, may be the most expensive of the options. However, if you are hiring the labor to sand your hull, peeling the gelcoat can be cost effective, especially if you consider the additional time and expense of fairing the sanded hull. After the gelcoat is removed, inspect the laminate for hydrolysis, delamination or other damage. Wash and sand the surface thoroughly before barrier coating.

10.3.4 Sounding the hull

You may find it a worthwhile investment of time to “sound” the entire hull. Wet or delaminated areas will sound dull or flat when rapped with a small mallet. Dry, solid laminate will have a sharp sound. By tapping the hull in a regular pattern every 3" (7.5 cm), you should be able to isolate problem areas (Figure 10-4). Blistering or delamination voids within the laminate may affect the structural integrity of the hull and should be repaired.

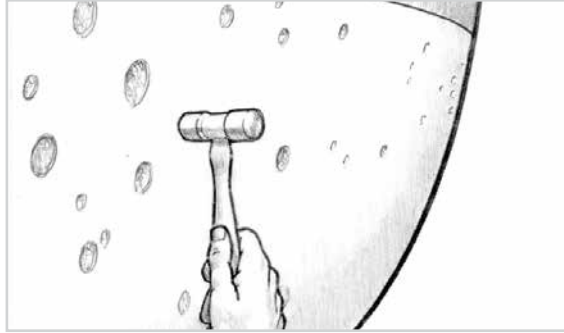

Figure 10-4 Sounding the hull will reveal interlaminar voids.

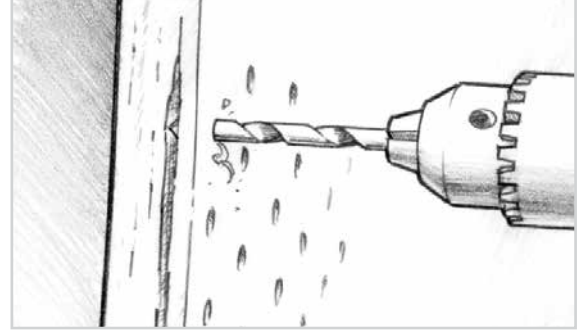

Figure 10-5 Drill a pattern of $\frac{3}{16}$ " holes through the outer laminate, into the void.

10.4 Exposing and removing interlaminar damage

After grinding or peeling away the gelcoat, wet the surface of the exposed laminate with water will help you to see flaws below the surface. Voids appear as lighter areas within the darker solid laminate. Voids may be the result of hydrolysis or a manufacturing flaw, which may show up in a pattern that reflects the pattern of resin application. Sounding will confirm the presence and extent of the voids. The deeper or more widespread the delamination, the more serious the structural problem. If sounding or visual inspection reveals voids below the outer layer of laminate, open the voids by drilling or grinding to allow the laminate behind the voids to dry out thoroughly before repairs are made.

10.4.1 Small voids

If the area of a void is limited to a few inches, you can repair it without removing the outer layers of laminate. Drill a pattern of $\frac{3}{16}$ " diameter holes over the area of the void (Figure 10-5). Drill through the outer laminate without drilling past the void into the laminate below. The holes will allow you to evaluate the size of the void, the soundness of the laminate below the void and help the void to dry out.

Dry the laminate (Section 11) and complete the repair as described in Section 12.3.

10.4.2 Large voids

If larger areas of delamination are confined to the first layers of laminate or to limited areas of the hull, you can restore the structure by removing the damaged material and bonding in new layers of fiberglass cloth with epoxy.

1. Mark the location and area of all of the voids with a felt marker.
2. Grind out all of the damage, exposing solid undamaged laminate.
3. Bevel the edge of the repair area to a minimum 12-to-1 angle to provide a greater bonding area and reduce stress concentrations (Figure 10-6).

After drying thoroughly, layers of fiberglass cloth must be bonded (laminated) over the repair area to restore the laminate to its original thickness and strength as described in Section 12.3.2.

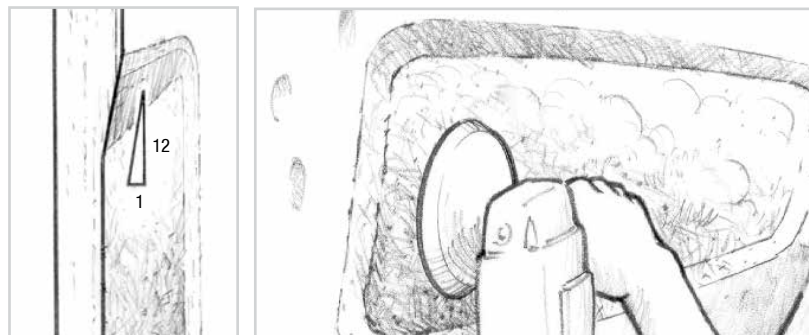

Figure 10-6
Grind away the laminate over large voids to expose solid laminate. Grind the edge of the repair area to a minimum 12-to-1 bevel.

10.4.3 Hydrolysis

Evidence of hydrolysis within the laminate may appear as “fiber whitening.” In normal or healthy laminate the fabric fibers below the surface are translucent and unnoticeable. If the resin around the fibers has hydrolyzed, the fibers appear white and are noticeable through the laminate after wetting the surface with water.

1. Inspect the hull to determine the extent of the damage after the gelcoat is removed.
2. Grind or peel to remove all of the hydrolyzed material in the outer layer of laminate. This may include isolated areas or the entire area of the hull.
3. Inspect the layer below the area(s) that were removed and (if necessary) remove all of the hydrolyzed material. Repeat the procedure one layer at a time until all hydrolyzed layers are removed.

Dry the hull thoroughly (Section 11) and bond on (laminate) new layers of fiberglass cloth to replace any roving or other structural layers that were removed (Section 4.3.2). The outer layer of chopped strand mat is not usually considered a structural layer.

Note! If you are unsure of the extent of damage or question the soundness of the hull, it's a good idea to get professional advice before attempting repairs. In severe cases, laminate analysis by a composites lab is advisable. Labs can analyze the laminate layer by layer for resin content, evidence of hydrolysis and moisture content. Contact a local surveyor for help evaluating your hull and locating a lab.

10.5 Special preparations for new boats

An epoxy barrier coating is often applied to brand new hulls to avoid blister problems. New boats, obviously, have no blisters or water in the laminate, but they may require preparation not required by older boats. Check with your boat's manufacturer to be sure this procedure does not negate the hull warranty.

If bottom paint was applied by the boat manufacturer, it must be completely removed by scraping, sanding or chemical stripping before applying the barrier coat. Failure to do so will result in the epoxy bonding to the paint, rather than to the gelcoat. In such instances, the epoxy's bond to the boat is only as good as the bond of the old paint to the hull. The gelcoat must be thoroughly sanded to a clean, dull surface.

When new boats are delivered, provided bottom paint was not applied by the factory, they usually will have mold release agents or waxes on the gelcoat surface. These agents will prevent the epoxy coating from achieving a good bond to the gelcoat and must be removed. Sanding alone is usually ineffective since wax or silicone tends to clog the sandpaper, making it very difficult to remove all traces of the substances.

1. Wipe the gelcoat surface twice, using a quality silicone and wax remover such as DuPont Prep-Sol™ #3919S and clean, white paper towels. (The dyes used in patterned toweling may also contaminate the surface.) Wipe well above the waterline to minimize the chance of contaminating the surface while you're working on the bottom.
2. Abrade the gelcoat below the waterline. This can be done with 80-grit sandpaper on an orbital sander, a double action (DA) sander or an air file, or by waterblasting or sandblasting. The entire hull surface must be dull with no shiny patches visible. Proceed to Section 13—*Barrier Coating*.

11 Drying the Laminate

Perhaps the most crucial step of the repair process for a boat which has blistered or absorbed moisture is thoroughly drying the laminate.

11.1 How dry is dry?

True moisture content of a laminate is extremely difficult to determine. In fact, the only accurate measure is to cut a core sample from the hull, weigh it and begin drying it in an oven. Then weigh the sample periodically until it no longer loses weight. The difference between the beginning “wet” weight and the final “dry” weight, expressed as a percentage, is the moisture content of the laminate.

Obviously, this is not a very practical method of determining moisture content. To compound the issue, the moisture content in various sections of the hull can vary dramatically. The potential for moisture absorption in fiberglass laminates is substantially different from wood, a substance about which a great deal is known. Under certain conditions, a piece of wood may attain 100% moisture content. Moisture is drawn into the wood’s cell structure and distributed throughout the sample fairly evenly.

A nearly perfect polyester laminate, with very few voids or resin-dry pockets, will absorb, at best, approximately 3% moisture by weight. And the worst case we’ve ever seen with a poorly built laminate was 9 or 10%. The principle difference is that a polyester laminate will absorb moisture unevenly in random pockets; the moisture content may be vastly different over a very small section.

11.1.1 Determining moisture content

To monitor drying progress, you’ll need to determine the moisture content of the hull. There are now inexpensive, non-destructive moisture meters on the market (see Appendix A). One must be aware, however, that the reading these units give is relative only, and not an accurate representation of the actual moisture content of the laminate.

To monitor the laminate’s drying progress using a moisture meter, we recommend taking and recording readings at regular intervals above and below the waterline along the entire length of the boat. During the drying process, periodically take and record new readings at the same locations (Figure 11-1). After a period of time, the drop in relative moisture content will level out. At this point, even though the meter readings may indicate 2 or 3%, it is reasonable to expect that the laminate is as dry as it can be made under the conditions at hand.

A simpler method is to tape a 6"×6" (15 cm×15 cm) square of 6-mil clear plastic to several locations on the hull, above and below the waterline (Figure 11-2). The edges should be tightly sealed, using electrician’s or duct tape. As the hull dries, moisture will condense on the plastic. Every three or four days, remove the plastic, wipe the hull and plastic dry, and tape the piece back in place. When the hull is nearing its lowest possible moisture content, very little condensation will appear inside the plastic. There are also outside variables to keep in mind, such as changing relative humidity and temperature. So, before pronouncing your hull dry enough, allow the patch to stabilize over several days. Keep in mind that, like the moisture meters, this little test is only an indicator of relative moisture content.

11.1.2 Washing the hull

As the hull dries, contaminants such as salts, glycols, and acids will come to the surface and may inhibit the drying process. Steam cleaning, high-pressure washing, or scrubbing with a stiff brush and warm water to remove these contaminants periodically throughout the drying process has been shown to speed the process. The frequency of washing depends on the drying speed, since contaminants will be left on the surface at a faster rate when

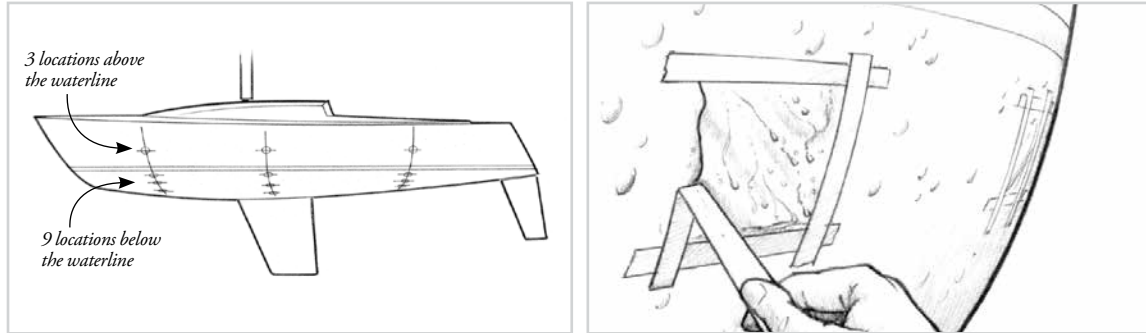

Figure 11-1 Moisture reading should be taken at various locations, above and below the waterline, during the drying process. **Figure 11-2** A piece of plastic taped to a wet hull will show condensation on the inside of the plastic.

the hull dries faster. If an active or accelerated drying method is used, washing every 48 hours may be appropriate. If the passive method is used in a cooler or more humid region, washing once a week is more appropriate. In a warmer, drier region, wash more frequently. A moisture meter will provide a good information on when to wash. If after an initial drop, the moisture level stays constant, wash the hull. After washing, the moisture level should drop then level off again as contaminants build up. Continue washing and monitoring until the hull is dry. If the moisture level remains high after washing it may be an indication of hydrolysis damage. Analysis by a composites lab is recommended.

11.2 Passive drying

Passive drying is simply storing the boat in the driest environment possible, for as long as it takes to reach the optimum moisture level. Drying time depends on the temperature and humidity level. Passive drying is a very practical method for boat owners in temperate climates, who normally store their boat over the winter. Although drying slows down considerably in cold weather, several months of winter usually provides enough time to adequately dry out the laminate. The boat should be protected from the elements and ventilated to dry the interior as well as the exterior. Check the hull with a moisture meter to be sure it is dry.

In tropical climates, passive drying is not always practical. Although it is warmer, high humidity slows drying speed. In areas where the cost of extended storage is a consideration, active drying is often the more economical method.

With either method, open up the blister cavities and thoroughly abrade or remove the gelcoat as soon as possible after your boat is pulled from the water.

11.3 Active drying

When time or the expense of storage space is a factor, several alternatives are available to accelerate drying.

11.3.1 Tenting

One method to accelerate the drying time, particularly if you are in a warmer, humid climate, is to enclose the bottom of the boat in a plastic tent and place dehumidifiers inside the tent. This can be as simple as taping a plastic skirt around the hull, above the waterline, using electrician's tape (it's much easier to remove from the fiberglass surface) and weighting the bottom of the plastic to seal the tent (Figure 11-3). Plastic should also be placed on the ground to completely seal the bottom of the boat. Small fans to keep air moving around the hull will also help. If you're particularly industrious, or if you'll be drying out many boats, you may want to construct a full-size, frame-and-plastic drying shed (Figure 11-4). In cooler climates, electric heaters can be installed inside the tent in addition to the dehumidifiers.

11.3.2 Heaters

Heat is an important factor in accelerated drying. The warmer the temperature, the more water molecules move around and pass through the laminate. Various types of portable heaters may be used to accelerate drying. Electric and catalytic heaters that generate long wave infrared radiation work well and are relatively safe, but use caution to avoid overheating the laminate. Be aware of the dangers of using heaters in an enclosed space and follow all manufacturer's recommendations for the safe use of heaters. Unvented fuel heaters (fuel oil and kerosene) should not be used when tenting. Aside from the dangers of asphyxiation, these types of heaters have been known to contaminate a hull's surface. 100°F temperatures plus dehumidification can dry a hull in as little as two weeks.

11.3.3 Drying the interior

Moisture can penetrate the laminate just as easily from the interior as through the exterior and the bilge is often overlooked when drying the hull. Use sponges to remove all bilge water and provide adequate ventilation within the boat. Open up hatches, cabinets and floor boards to allow free air circulation. To accelerate drying, you may install fans, heaters or a dehumidifier in the boat.

Once the laminate is dried enough to avoid further hydrolysis and provide good bonding, the necessary filling and fairing and coating can proceed as described in Section 12.

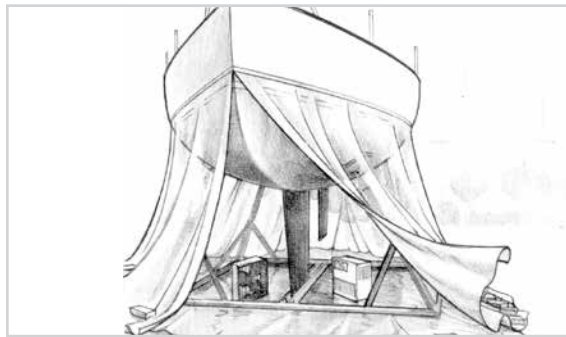

Figure 11-3 Drying the hull can be accelerated by tenting the hull with a plastic skirt, taped just above the waterline.

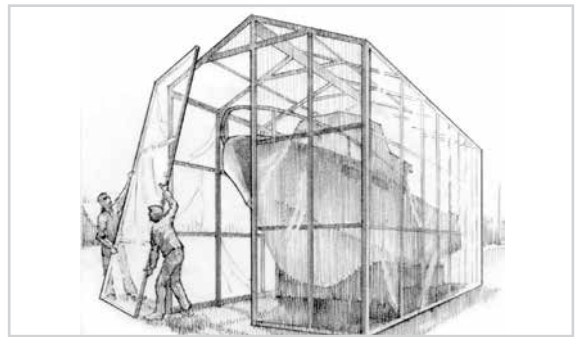

Figure 11-4 For yards repairing many boats, a drying shed built of lumber and plastic (on the order of a greenhouse) can free up valuable shop space.

12 Repairing Blister Damage

This section describes the procedures for filling and fairing minor isolated blister cavities that were prepared in Section 10.2. It describes the repair of extensive blister damage described in Section 10.3 and delamination described in Section 10.4 after the hull laminate has dried out.

12.1 Minor isolated blister damage

The following repair method is specifically tailored to fix minor individual blisters prior to bottom painting. The advantage of this method is that the repair can be completed in a

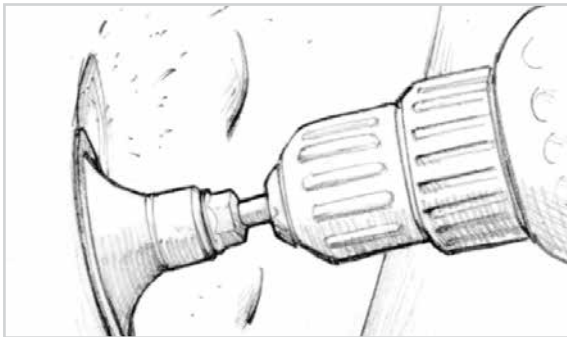

Figure 12-1 Open the blisters with a sanding disk removing the entire blister.



Figure 12-2 Wipe the cavity clean with alcohol and repeat until the laminate is dry to the touch.

matter of hours and requires no barrier coating prior to bottom painting. It can be used to repair blisters on hulls that have been recently pulled from the water or on hulls that have been out of the water for some time. Continue the repair after opening up the blisters as described in Section 10.2.

1. Open blisters with a small abrasive tool like 3M's Rolock™ 2" diameter sanding disk with 60-grit sandpaper. Make sure you have removed the entire blister, including the edges of the blister dome.
2. Wipe the cavity clean with an alcohol prep pad or paper towels that have been soaked in isopropyl alcohol. Be generous with the alcohol and change towels frequently so the contaminants are removed rather than spread. Repeat the alcohol wipe process and allow the laminate to dry to the touch. It is particularly important to repeat the alcohol-wipe on blisters that were fluid filled at the time they were ground away.



Figure 12-3 Wet out the cleaned blister cavities with unthickened epoxy.

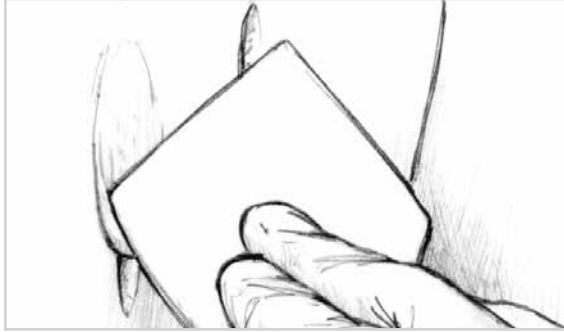

Figure 12-4 Fill the cavities with epoxy thickened with 406 Colloidal Silica filler.

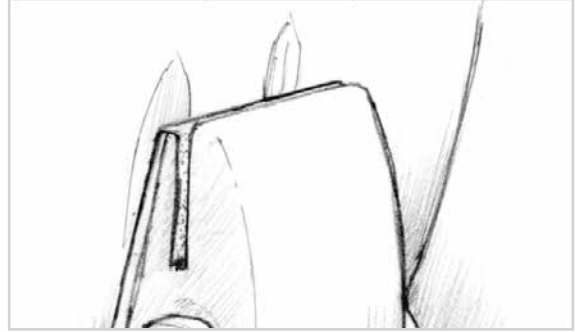

Figure 12-5 Wash with water and sand with 100-grit sandpaper or wet sand with 80–120-grit.

3. Fill the cavities with Six10 Thickened Epoxy Adhesive dispensed through the static mixing wand. Alternatively, you could use WEST SYSTEM 105 Resin-based epoxy to coat the blister cavities and then fill with 105 Resin-based epoxy thickened with 406 Colloidal Silica Filler.
4. Spread the Six10 Adhesive flush with the surrounding hull with a wide putty knife or plastic spreader. Avoid overfilling the cavities because Six10 is difficult to sand.
5. Wet sand with 80-120 grit wet/dry sandpaper or wash with water (no soap, no ammonia) and sand dull with 100-grit sandpaper. If you are using Six10 in warm conditions, you should be able to wet sand and bottom paint later the same day. If working in cooler temperatures, allow the epoxy to cure overnight before sanding.
6. Apply your bottom paint of choice.

Six10 Adhesive epoxy is recommended for this application because it is epoxy thickened with fumed silica, which allows the epoxy to remain an excellent moisture barrier. When the static mixer is used to dispense the epoxy, the blister cavity is filled with air free epoxy. This is important because small bubbles in coatings and putties degrade moisture barrier potential by creating short cuts for moisture to permeate the hull. Six10 produces a moisture barrier that is better than the original gelcoat. This makes Six10 a great solution for filling ground out blister cavities—especially if you don't plan to barrier coat your hull.

12.2 Extensive blister damage

Once the blister cavities have been opened, as described in Section 10.3, and the hull has been dried out and cleaned, the cavities must be filled and the surface faired. Drying time may have been anywhere from a week to several months, depending on the drying method and how wet the laminate was. During the drying period, trace particles of solutes may have leached out and remain on the surface. These elements must be removed because they are likely to cause bonding problems. Begin the filling process as follows:

1. Pressure wash, or scrub the surface with an abrasive pad or stiff brush while flushing with fresh water to remove contaminants (Figure 12-6). The brief exposure to the fresh water won't drive up the moisture content of the laminate. Wipe dry with clean paper towels.
Avoid washing with solvents, unless a particular contaminant is not water soluble. If you must use solvents, apply and dry with paper towels before the solvent evaporates. Do not use rags to apply or remove solvents
2. Allow the hull to sit overnight to allow the surface to dry completely. Be sure any condensation on the hull has dried before proceeding. Fans or heaters directed at the surface may allow you to start the repair earlier in the day.
3. Wet out the repair area with unthickened epoxy. Doing so will saturate exposed reinforcing fibers, and will provide a good, secondary bond to the cured polyester resin. Each blister cavity should be saturated with the resin/hardener mixture, taking care to work the epoxy into cracks or crevices with a disposable brush or coat the entire area, applying the epoxy with a foam roller cover. Remove air bubbles by tipping off the surface

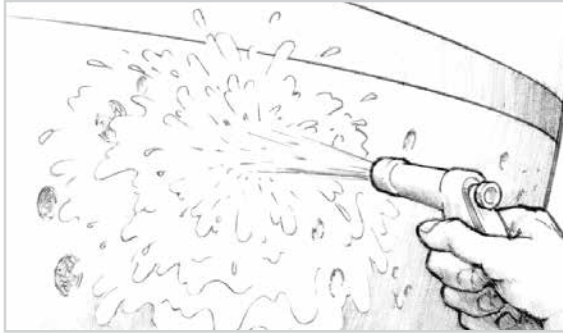

Figure 12-6 Scrub the surface with a stiff brush while flushing with fresh water to remove contaminants. Allow to dry completely

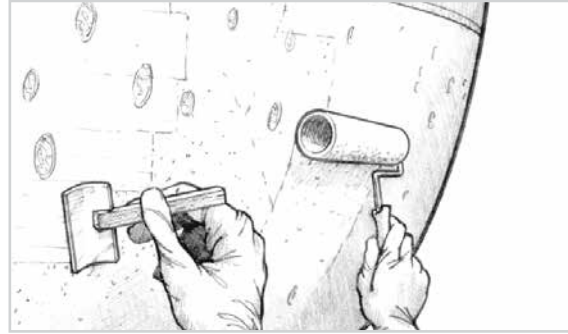

Figure 12-7 The entire hull or large areas may be wet out with a foam roller. A foam roller brush will remove bubbles and roller marks.

with a foam roller brush (Figure 12-7). Wet out individual cavities with a disposable brush as necessary to be sure each cavity is well coated. Wait for 30-60 minutes before beginning the next step. This will allow the wet-out coat to cure slightly and prevent the thick fairing mixture from sliding. See Section 16.2 for information on cure times.

4. Prepare a fairing compound by mixing resin/hardener and either 407 or 410 filler to a non-sagging peanut butter consistency.
5. Apply the fairing compound into the blister cavities with a plastic spreader before the wet-out reaches its final cure phase. If the wet-out coat has reached its final cure, wash and sand the surface before applying the compound. Hold the squeegee at a low angle to leave the mixture smooth and filled slightly higher than the surrounding surface (Figure 12-8). Remove any excess epoxy before it cures.
6. Allow the fairing compound to cure thoroughly. For details on cure time see Section 16.3—*Handling Epoxy*.
7. Sand the surface fair following the procedures outlined in Section 16.4.4 (Figure 12-9). Check for fairness. Reapply fairing compound as needed, repeating the procedure until the surface is fair and smooth.

12.3 Interlaminar damage

Sounding or visual inspection may have revealed voids or hydrolysis below the outer layer of laminate. After completing the preparation described in Section 10.4—*Exposing and removing interlaminar damage*, proceed with the appropriate repair.

12.3.1 Small voids

To repair small voids that have been pattern drilled with the outer laminate left in place as described in Section 10.4.1, first dry thoroughly. Then re-bond the separated laminate by injecting an epoxy mixture into the void as follows:

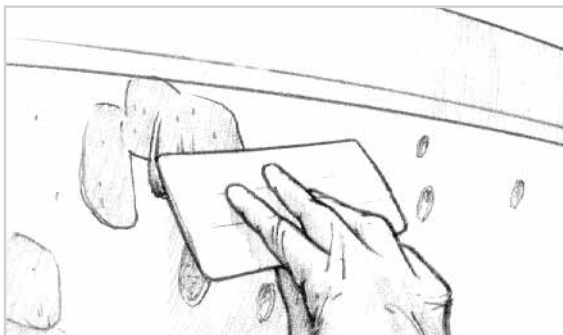

Figure 12-8 Trowel thickened fairing compound into the blister cavities with a plastic squeegee.

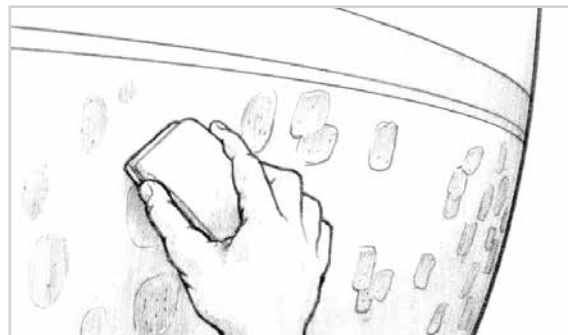

Figure 12-9 Sand the surface fair after the epoxy/filler has cured thoroughly.

1. Prepare an 807 Syringe for injecting an epoxy mixture into the voids. Cut 1" off the tapered syringe tip. This will leave a tip diameter of about $\frac{3}{16}$ ", which will fit tight when pushed into the drilled $\frac{3}{16}$ " pattern holes. Adjust the tip length/diameter to fit the hole diameters.
2. Prepare an epoxy mixture of resin/hardener and 406 Colloidal Silica Filler to a catsup consistency or use Six10 Adhesive. Fill the syringe with the epoxy mixture. If the mixture is too thick to draw into the syringe, remove the plunger and pour the mixture in.
3. Inject the mixture into the void through the pattern holes. Force the syringe tip into the lowest pattern hole and inject the mixture until it reaches and begins to ooze from the surrounding holes (Figure 12-10).
4. Move to the next open hole and repeat the procedure. Continue injecting the mixture, filling the void from the bottom up, until all of the air in the void is displaced by the mixture.
5. Allow the epoxy to cure thoroughly. If any small air pockets remain, drill two holes through to the void on opposite sides of the void. Inject additional epoxy mixture into one of the holes. The second hole will allow air to escape.

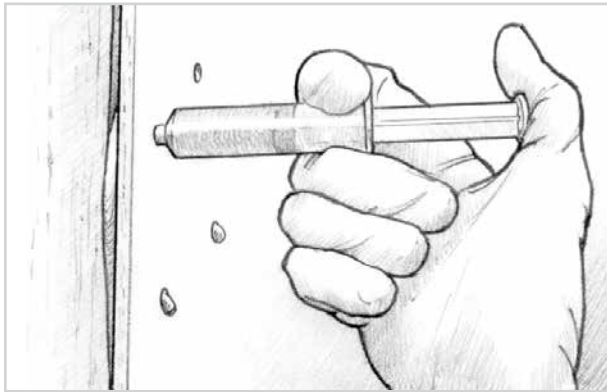

Figure 12-10 Inject the epoxy mixture until it reaches the surrounding holes.

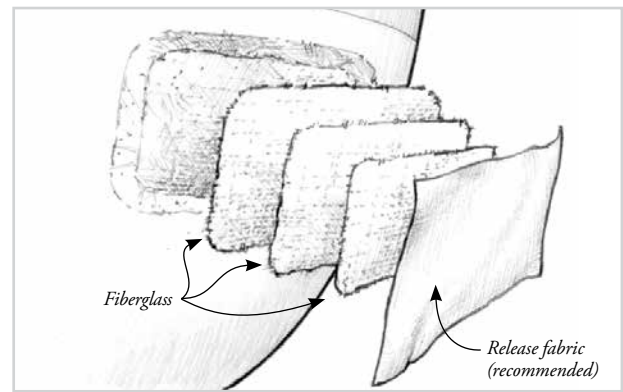

Figure 12-11 Rebuild the laminate to its original thickness using multiple layers of glass cloth, bonded with epoxy

12.3.2 Large voids

In instances of severe blistering, you may have to excavate large amounts of laminate. In such cases, it is best to restore the hull's structural integrity by replacing the excavated laminate with new fiberglass cloth bonded into place with epoxy. The new skin must be laminated to approximately the same thickness and strength as the original skin. Multiple layers of lightweight cloth will develop the same or greater strength than a single layer of heavy cloth. Use a fiberglass fabric such as WEST SYSTEM 740, 742 or 745 Episize™ Glass Fabrics.

Grind out all of the damaged area, exposing clean, solid laminate. Bevel the edge of the repair to a 12-to-1 angle, as described in Section 10.4.2, allow the laminate to dry thoroughly and rebuild the excavated laminate as follows:

1. Cut an appropriate number of pieces of fiberglass cloth the same shape as the repair area. The first piece should be slightly smaller than the outside of the beveled edge with subsequent pieces gradually getting smaller. The final layer should be the same size as the bottom of the bevel, and the combined thickness of the layers should be slightly thinner than the original panel to allow for final shaping and fairing. Also cut one piece of WEST SYSTEM 879 Release Fabric or peel ply, several inches larger than the repair area. This will be used to smooth the patch into place (Figure 12-11).
2. Wet out the repair area with a resin/hardener mixture (Figure 12-12).
3. Apply a layer of thickened epoxy to the entire repair surface (including the beveled edge) with a plastic squeegee (Figure 12-13) after the wet-out has reached its initial cure stage. Mix resin/hardener and 406 Colloidal Silica filler to the consistency of mayonnaise. Apply a thick enough layer to fill any voids or unevenness in the surface and make solid contact with the layers of cloth.

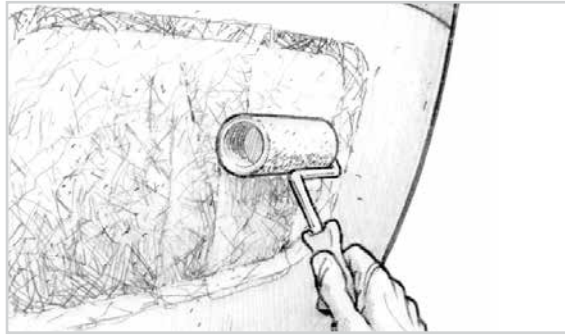

Figure 12-12 Wet out the repair surface with unthickened epoxy. **Figure 12-13** Apply a layer of epoxy/406 thickened to a mayonnaise consistency.

4. Apply the wet-out layers of cloth.
 - a. Place the largest piece of cloth on a flat, plastic-covered surface (Figure 12-14). Pour a small amount of mixed epoxy in the center of the piece and spread the epoxy into the cloth with a squeegee. As the cloth is wet out, it becomes transparent.
 - b. Wearing disposable gloves, lift the cloth into position and smooth out bubbles and excess epoxy with the squeegee.
 - c. Repeat the process for each layer of fabric until you have bonded the smallest piece in place last. Place each piece of cloth in the center of the previous piece. Do not wait for each layer of fabric to cure; you may bond to the still-wet previous layer.
5. Cover the repair with release fabric and smooth the patch with the squeegee, squeezing out air and excess epoxy (Figure 12-15).
6. Remove the excess from the surrounding areas with a beveled mixing stick or plain paper towels before the epoxy begins to cure.
7. Allow the patch to cure thoroughly.
8. Peel the release fabric from the cured patch.
9. Sand and fair the surface following the fairing procedures in Section 14. Begin the final barrier coating operation within 24 hours of the final sanding.

12.3.3 Hydrolysis damage

Hydrolysis most often penetrates to a uniform depth over the entire hull, progressing from the outer layer inward. This means that laminate is most often removed to a uniform depth or specific layer of chopped strand or woven roving. Removal of hydrolyzed laminate usually means peeling or grinding off the outer chopped strand layer if the damage is light and one or more layers of woven roving if the damage is more severe.

Generally chopped strand laminate is nonstructural. If this layer only is removed, the hull can be prepared (Section 16.4.1), faired and barrier coated without replacing it. Woven

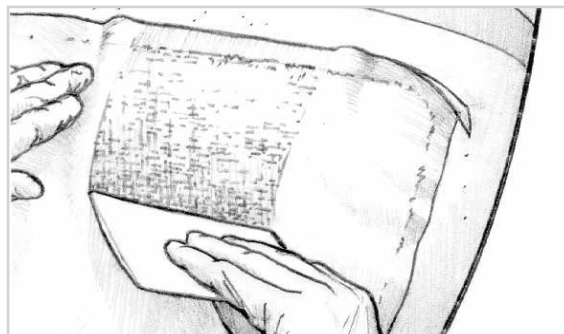

Figure 12-14 Wet out each piece of cloth with unthickened epoxy and squeegee into place.

Figure 12-15 Cover the cloth with a piece of release fabric and squeegee air and excess epoxy from the lay-up.

roving is structural and should be replaced with one or more layers of woven fabric that roughly equals the roving's weight or thickness. For example, if a 24 oz. layer of roving is removed, it can be replaced with two layers of Epi-size 745 (10 oz.) Glass Fabric, or one layer of 738 Biaxial Fabric (approximately 22 oz.).

Apply the fabric following the procedure in Section 16.4.5. The wet method of application may be preferred when working on the underside of the hull. See Appendix C for fiberglassing overhead.

After all repairs and fairing are complete, proceed to Section 13—*Barrier Coating*.

13 Barrier Coating

After preparing and drying the hull, and repairing all blister and laminate damage, the next operation is to apply the moisture barrier. A minimum 20-mil (0.020") coating of WEST SYSTEM Epoxy with 422 Barrier Coat Additive is recommended for good protection and can be applied in 5 or 6 coats at room temperature. Note that epoxy is thinner at higher temperatures, resulting in a thinner buildup per coat. At higher temperatures, more than six coats may be required to achieve a 20-mil thick barrier coat.

Additional coats can provide additional protection. However, the benefits of the protection can vary depending on the boat's susceptibility to hydrolysis and its future environment. Boats that will sail in cooler waters and showed little evidence of hydrolysis, will gain little added protection from additional barrier coats. Boats in tropical waters, that showed vulnerably to hydrolysis and blistering, will gain a greater degree of protection from additional barrier coats. In some situations, the additional protection up to 10 coats of epoxy is worth the expense.

See Section 10.5 for information on preparing a new boat for barrier coating.

13.1 Preparation

Avoid starting your epoxy coating application too early in the day. If the boat has cooled substantially during the night, condensation may occur when the ambient air temperature rises faster than the temperature of the hull and keel. Solid lead keels may take considerably longer to warm than the hull. You may want to bring the surfaces up to temperature using heat lamps. Although WEST SYSTEM Epoxy will cure at lower temperatures, it will be easier to achieve a uniform coating if the epoxy is applied between 60°F (16°C) and 80°F (27°C).

One objective when applying multiple coats of epoxy is to avoid the necessity of sanding between coats. This is possible if all 5 or 6 coats (or more) can be applied in the same day or if each coat can be applied before the previous coat has reached its final cure phase (Section 6.3.1). You may begin to apply a coat as soon as the previous coat has reached its initial cure phase or has solidified enough to support the weight of the next coat, without sagging. The time between initial cure and final cure will vary with the choice of hardener and the ambient temperature. (See Section 6.3.2—*Handling Epoxy*.) If you have no choice over working temperature, chose a hardener that lets you work at a pace you can handle.

Coating a large hull is a big job, one that is ideally handled by two or more people. Before starting, organize your materials, application tools and work area. Decide on everyone's role in the operation and how much of the hull you can efficiently coat in one day. Once you begin, you won't want to stop the procedure.

13.1.1 Planning for one-day coating

A 5 or 6 coat application of epoxy on a small (20' to 30') hull should be a manageable one-day operation for two people. If you have a larger hull or limited help, you can still avoid having to sand between coats or being committed to an unreasonably long coating operation. Rather than applying a few coats to the entire hull on day one and the remaining coats on day two, it would be better to apply all 5 or 6 coats to one half of the hull on day one and all 5 or 6 coats to the other half on day two. Larger hulls may be divided into as many one-day operations as is convenient for you and your crew under your particular working conditions. Only the small area of overlap between one-day coating areas needs to be washed and sanded instead of the entire previous coat.

13.2 Applying the barrier coat

The first coat of epoxy is always applied without additives for maximum penetration or “keying” into the surface. Additives may be added to the second and following coats. Apply the first coat of epoxy within 24 hours of the final sanding.

First coat

After all the preparations are completed, apply the epoxy barrier coat as follows:

1. Remove all of the sanding dust with a brush or vacuum. Mask the hull at the waterline with electrician’s tape.
2. Prepare a batch of resin/hardener, mixing approximately 8 ounces (236 ml or 8–10 Mini Pump strokes) at a time. Stir the mixture thoroughly and pour into a roller pan immediately after mixing. Do not use additives in the first coat of epoxy.
3. Apply the epoxy to the hull following the coating procedure in Section 15.1.1. Spread the epoxy out to a thin even film with the thin foam roller (Figure 13-1). Continue applying the epoxy, overlapping small coverage areas until the batch is used up.
4. Fill pinholes in the surface by squeegeeing the freshly applied epoxy with a stiff plastic or metal spreader. It is important to fill pinholes in the sanded laminate and fairing compound at the first stage of barrier coating. Hold the spreader at a low angle to avoid scraping away epoxy. Press the spreader firmly against the surface and drag the spreader in long, overlapping strokes to “hydraulically” force the epoxy into the pinholes (Figure 13-2). Fill the pinholes in each batch area before applying the next batch of epoxy.

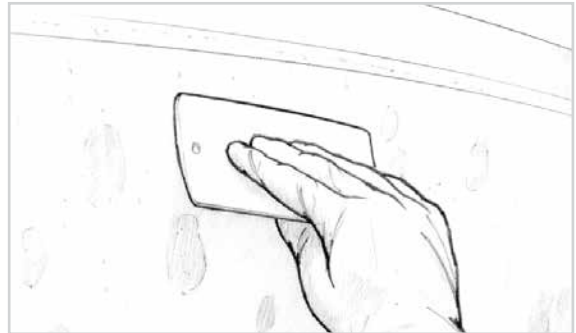
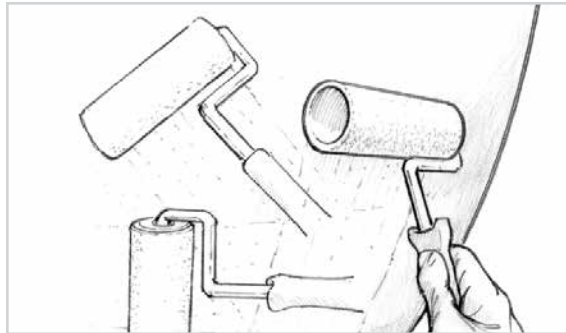

Figure 13-1 Apply a thin, even film of epoxy with a foam roller. **Figure 13-2** After each batch of epoxy is applied, fill pin holes with a plastic squeegee or spreader. Use firm pressure and hold the squeegee at a nearly flat angle.

5. Apply a second coat of epoxy to the hull before the first coat becomes tack free. Spread the epoxy out to a thin even film with the thin foam roller (Figure 13-3). Continue applying the epoxy, overlapping small coverage areas until the batch is used up.
6. Tip off the freshly applied batch area before you begin applying the next batch. Drag a foam roller brush lightly over the surface in long overlapping strokes, in one direction, to remove roller marks and air bubbles in the coating. You will find that the thinner the coating, the smoother the finish after tipping off. You may choose to have a helper preparing your next batch of epoxy then tipping off behind you while you continue rolling (Figure 13-4).

It’s important that these air bubbles be removed from the surface before the epoxy begins to cure. Our research indicates that an epoxy coating with air entrapment (bubbles) provides significantly less moisture exclusion ability.

7. Continue rolling and tipping off batches of epoxy until your one-day coating area is covered. The batch sizes may be adjusted depending on the amount of working time the hardener and ambient temperature will allow. Mix no more than you can apply and tip off before the batch begins to thicken. (A roller pan cooler box will help to extend the

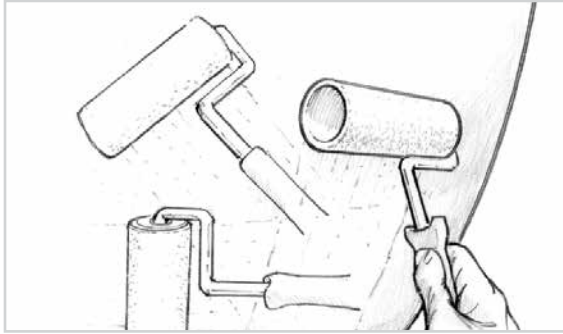

Figure 13-3 Apply a thin, even film of epoxy with a foam roller

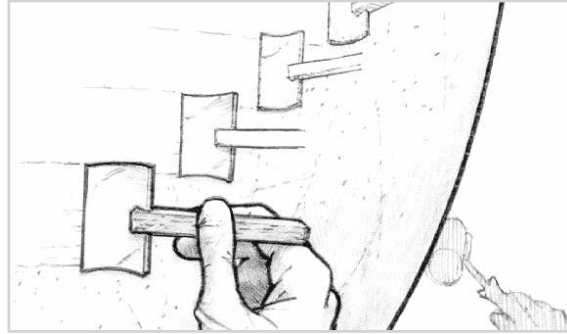

Figure 13-4 Tip off each fresh coat of epoxy with a foam roller brush to reduce bubbles and roller marks.

working life of each batch or allow you to mix larger batches. This is especially useful in warmer climates.

See Appendix A for Tools and Equipment details. See Appendix B for Gelcoat Blister Repair and Coating Estimate Guide.

The roller cover and roller cover brush will need to be replaced occasionally as the epoxy saturating the covers from the first batches begins to cure and build up on the cover. Be sure to have enough covers on hand to complete your one-day coating area. Allow two covers per coat per coating area. When you have finished coating, remove the roller cover before it bonds to the frame.

Build up coats

You may begin the second coat as soon as the first coat of epoxy has reached its initial cure. To avoid sanding between coats, the second coat must be completed before the first coat reaches its final cure phase. In most cases, by the time you've coated an entire hull, the first section should be ready for the next coat.

1. Prepare an 8-ounce (236 ml) batch of epoxy—stir thoroughly. Add approximately 3 tablespoons (56 g) of 422 Barrier Coat Additive to the epoxy mixture and stir thoroughly. WEST SYSTEM 422 Barrier Coat Additive performs several important functions. This specially blended, aluminum-based powder further improves the substantial moisture exclusion effectiveness of the epoxy barrier coat and increases abrasion resistance. The additive also turns the normally transparent epoxy opaque, which helps as a visual indicator of coating uniformity during application.
2. Apply this mixture as before, tipping off each batch of epoxy with a foam roller brush as you go (Figure 13-5). Tip off each coat in a direction perpendicular to the previous coat. (i.e. 1st- horizontal, 2nd- vertical, 3rd- horizontal, etc.).
3. Repeat this process for the remaining five coats of epoxy/barrier coat additive. If you are unable to apply all of the coats in one day, allow the last coat to cure thoroughly. Prepare the surface for bonding (Section 16.4.1) before applying the next coat.

13.3 Bottom paint

Allow the final coat of epoxy to cure for at least 24 hours. Wash the epoxy surface with clean water and a 3M Scotch Brite™ pad to remove amine blush, and then sand (wet or dry) the surface smooth with 80–120-grit sandpaper (refer to paint manufacturer's recommendation). Use caution when sanding; remove only the irregularities in the topmost coats of epoxy. Do not sand through the top barrier coat.

Remove sanding dust, and immediately apply a quality, marine-grade bottom paint. Follow the paint manufacturer's instructions for your particular bottom paint.

For a smooth racing finish, after the bottom paint has dried for 12 hours, use a 3M Scotch Brite pad or fine-grit sandpaper to remove minor surface flaws. Additional coats of bottom

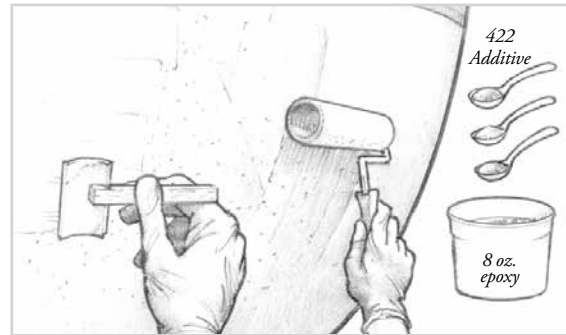

Figure 13-5 Add 422 Barrier Coat Additive to the second and remaining coats to increase moisture and abrasion resistance. When tipping off, alternate stroke direction with each coat. (i.e. 1st- horizontal, 2nd vertical, 3rd- horizontal, etc.)

paint (if desired) can then be applied directly to this surface, again following the paint manufacturer's application instructions.

Note: Most bottom paints tested at Gougeon Brothers have proven to be compatible with cured WEST SYSTEM Epoxy surfaces when applied following the procedure described above. However, the reformulation of many bottom paints due to compliance with new environmental restrictions may affect the compatibility of a particular paint. If you have any doubt about the compatibility of a bottom paint, we recommend building a test panel or calling the Gougeon technical staff.

No-sand primers

No-sand primers are formulated to prepare a surface so that the need for sanding is eliminated. They work quite well on polyester gelcoat surfaces for bottom paint preparation; however, we've found that their performance is unreliable when used on an epoxy base. Therefore, until our research proves otherwise, we do not recommend the use of no-sand primers after the epoxy barrier coat has been applied, and prior to applying bottom paint.

13.4 Recommendations for blister prevention

Section 9.3 listed five recommendations for the prevention and repair of gelcoat blisters. You've invested considerable time, effort and money to complete three of the recommendations. Thorough drying, repair, and the application of a proper epoxy barrier coat will greatly reduce the likelihood of re-blistering. To help protect your investment and further reduce the possibility of blistering, we urge you to follow the two additional recommendations:

1. KEEP THE INTERIOR DRY.
2. MAINTAIN THE BARRIER COAT.

Keeping the interior dry

1. Keep the bilge as dry as possible. Moisture can enter the laminate from the inside as easily as it does from the outside.
2. Check for leaks in water, waste, and fuel tanks. Drain water and waste tanks during the off season to prevent condensation on tank surfaces.
3. Keep the engine sump free of oil that may seal moisture in the laminate. Use a clay-type oil absorber to soak up large amounts of oil and follow up with a degreaser or detergent cleaner. Also keep the sump free of antifreeze which will attract moisture to the surface and can penetrate the laminate.
4. Assure adequate ventilation next to the hull. Provide air movement through lockers and engine compartments, and behind liners, cabin soles, tanks, etc. Condensation will form on boats kept in areas of wide temperature and humidity variation, especially on the cool hull surface below the waterline. Install plenty of appropriate sized louver/vents in panels that trap air and moisture against the hull. Use passive, electric or solar powered electric ventilators, with a flexible vent hose if necessary, to draw moisture from dead air spaces (Figure 13-6).

Maintaining the barrier coat

1. Haul the boat and inspect the bottom annually. Check for scrapes or damage to the epoxy barrier coat. Repair and recoat as necessary to maintain a continuous minimum 20-mil coat.
2. If possible, store the boat out of the water during the off season.
3. When sanding or high-pressure cleaning the bottom paint, be careful not to remove the epoxy barrier coat.
4. After several years of use or if your racing hull gets sanded regularly, apply one or two fresh coats of epoxy as necessary to maintain the recommended minimum 20-mil barrier coat thickness. Thoroughly sand the bottom, removing all bottom paint, and apply additional coats of epoxy/barrier as described earlier in this section. Chemical strippers are not recommended for removing bottom paint applied over the epoxy barrier coat. Strippers that contain methylene chloride may soften the epoxy barrier coat if left on long enough.
5. Avoid an excessive buildup of bottom paint. Remove old bottom paint before applying new paint.

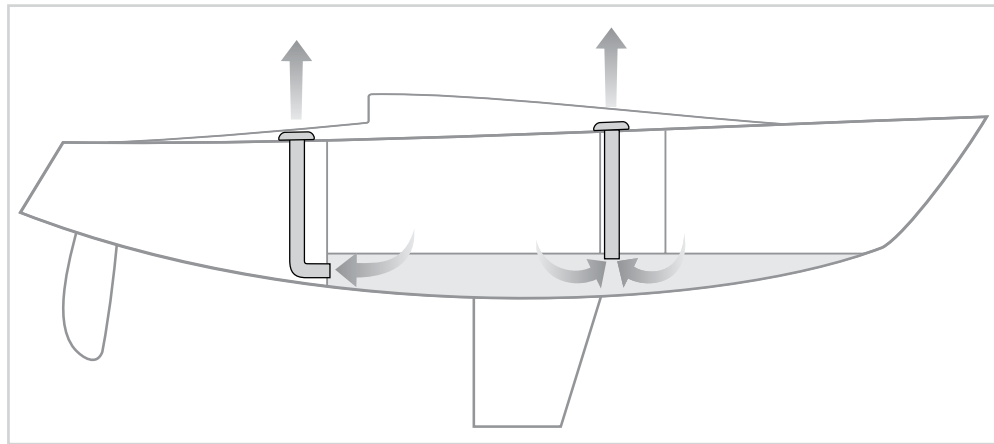

Figure 13-6 Solar or electric powered exhaust vents can be used to keep the bilge dry. Route a vent hose from the bilge to the deck mounted vent. Air will be drawn from the cabin down through the bilge and carry moisture out through the vent.

14 Final Fairing

Fairing is the process of creating or shaping a smooth line, edge or surface, free of hollows or bumps. In traditional boatbuilding, fairing is first employed during the layout of the many individual lines of the boat on the lofting floor, or on the less traditional computer aided design (CAD) program. Each line is described by a series of plotted points. If one or more points is out of place, the line will not be true or accurate. If the line connecting these points does not flow smoothly or continuously, the line will not be “fair”. Lines must be both true and fair. Plotting the points accurately requires careful measurement with a ruler, but the smoothness of a line flowing through those points is often best measured by eye. This is the conjunction of science and art in boatbuilding.

Properly lofted lines are then transferred to the profiles of the keel, bulkheads and frames. When assembled and properly aligned, their combined two-dimensional profiles describe the three-dimensional shape of the hull. If one or more of these components is out of place or unfair, the surface of the planking installed over them will not be fair. The skillful boatbuilder will keep the lines of the hull and deck surface both true and fair through all stages of construction, thereby reducing the amount of final fairing required. Up to a point, fairness is necessary to produce a hull that offers minimum resistance as it moves through the water. Beyond a certain point, the degree of fairness is a matter of personal pride and a reflection of the builder’s craftsmanship.

Final fairing is the last step in the fairing process. Its purpose is to correct any unevenness or flaws in the surface after the structure is completed. Final fairing begins with overall fairing, that is removing major high spots and/or filling low spots over broad areas. Then local fairing removes any remaining minor surface irregularities and makes the surface texture smooth to the touch.

14.1 Establishing a fair level

First consider the overall or general fairness of the surface, rather than individual or local high or low spots.

Imagine the earth without any water on it and you had the job of fairing it to a perfect sphere. You would have several options:

1. You could grind all of the land down to the lowest elevation (the bottom of the lowest ocean trench).
2. You could fill everything up to the highest elevation (the peak of Mt. Everest).
3. You could grind all of the land down to a specific level or elevation (sea level for example), and then fill the remaining low areas up to that level.

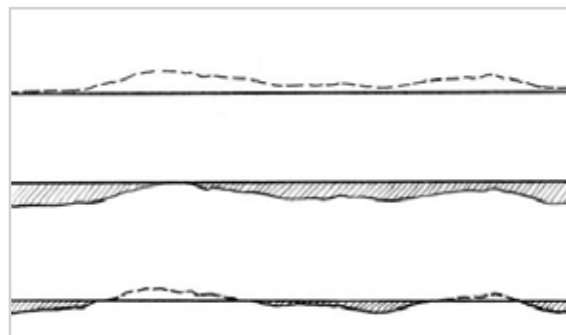

Figure 14-1 *Unfair surfaces can be:*
 1. *Ground down to the lowest level*
 2. *Filled to the highest level*
 3. *Ground to a specific elevation and filled to that level*

On a smaller scale, a fair surface on a boat hull is often achieved by removing material from highest areas until you reach a critical or convenient level or elevation, and then filling the remaining low areas up to that level (Figure 14-1).

The question of where to establish that level may be determined by the type and size of the boat, how accurately you want to maintain the hull's lines, the hardness or machinability of the surface material, the existing fairness and volume of material to be removed or added, skin thickness, whether the surface is to be finished clear or painted, the tools or equipment available, and your level of skill and endurance.

If you are fairing a wooden boat that you want to finish natural, such as a stripper canoe, you have little choice but to remove all of the high areas and establish the fair level at the lowest point on the surface, (option 1). This emphasizes the importance of keeping the hull fair throughout construction. If you are fairing a stripper canoe, for example, and one of the frames is $\frac{5}{16}$ " too high, you would have to alter the shape of the hull to avoid sanding a hole through $\frac{1}{4}$ " planking.

If you are fairing a hard surface like a fiberglass, aluminum or steel hull, or a lead keel, removing a lot of material is impractical. You are pretty much limited to filling the low areas and establishing the level near or above the highest point on the surface, (option 2). Many steel and aluminum boats are built this way. A layer of fairing compound is applied over the completed hull and all of the fairing takes place in the easy-to-sand fairing compound outside of the hull's metal surface.

14.2 Removing high areas

The first task in overall fairing is locating the high and low areas. Developing a good eye or feel for finding high or low areas may come naturally or with practice and trial and error. Whether you develop a good eye or not, a batten or chalk stick is an indispensable fairing tool. See Appendix A. A batten will also help you develop your eye by providing an accurate backup measurement to check against your eye and hand measurements.

As you hold the batten firmly against the surface, it will rest on the high spots and bridge the low areas. By moving the batten to different positions in an area, you should be able to get an idea of the surface topography.

Mark the high spots by applying carpenters chalk to the face of a batten, and rubbing the batten over the surface. The chalk will be deposited on the high spots (Figure 14-2). As you take the high spots down to fair, you can use the chalk stick as often as you like to monitor your progress. Continue removing high spots until you are satisfied with the fairness.

Methods for removing high spots depend on the material and how much of it needs to be removed. For aluminum, steel, fiberglass or other hard materials, a heavy duty disc sander may be the most practical tool to use. For rough fairing on wood or cured fairing compound, a plane, disc sander, belt sander or air file can be used, but some skill and experience are required to avoid sanding too deep. The short contact area of these tools also increases the risk of removing material from the wrong areas.

A long flexible sanding block, or fairing board, is the primary tool for overall fairing on wood and fairing compound. See Appendix A for information on making fairing boards.

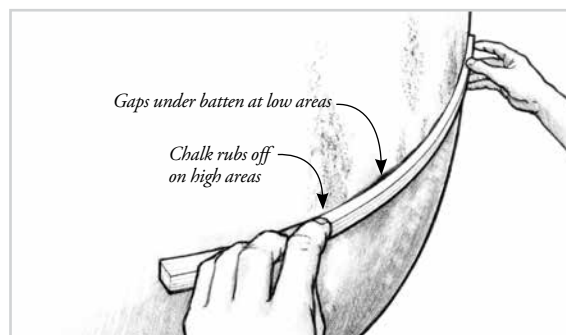

Figure 14-2 A batten will reveal the high and low areas, and the difference between them. Chalk applied to the batten will rub off on the high spots.

The key word is long, especially at early stages. Working on the same principle as the batten, the sanding board should bend to the overall shape of the surface, but be long enough and stiff enough to bridge the low areas and knock down the high spots over a large area. A short sanding block and most power tools at this stage will simply follow the contours and remove material from the low areas as well as the high areas.

We prefer aluminum oxide sandpaper as it seems to cut a wide range of materials, including cured epoxy/fairing material, better than other types of sandpaper. Zirconia alumina also cuts well and it wears longer. Stick sandpaper to boards and blocks with a feathering disc adhesive, or use adhesive backed sandpaper. Either will permit removal of the paper when replacement is needed. See Appendix A for more information about sanding tools and abrasives.

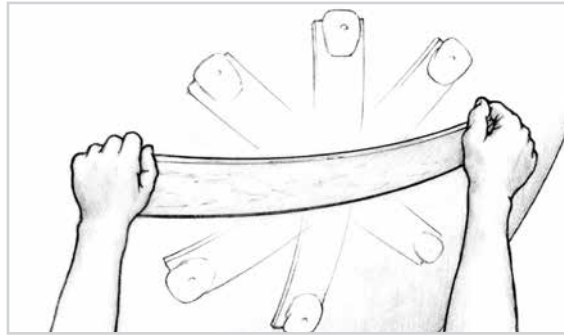

Figure 14-3 Vary the angle of the board (0°, 45°, 90°) to avoid sanding in or creating a valley

Begin your final fairing with 50 or 60-grit paper, concentrating on taking down the high spots over a broad area. Change sanding direction frequently and check your progress from time to time by eye or feel, or with a batten.

When you are getting close to final fairness, switch to 80-grit paper. If you will be clear coating wood, begin to sand only in the direction of the grain to remove and avoid cross-grain scratches. Vary the angle you hold the board to avoid sanding in or creating a valley (Figure 14-3). As a final check, place the batten in different positions on the surface. The batten should make solid contact everywhere on the surface with no voids anywhere along its length.

14.3 Filling low areas

If you will be painting the surface, you may decide that it is more practical at some point in the process to fill the remaining low areas with fairing compound rather than continue sanding high areas. Often the decision to begin filling low areas is determined simply by the volume of material remaining in the high areas and the time and effort required to remove it.

Four methods for filling low areas may be used depending on the area or volume to be filled and the degree of fairness and accuracy required. A large job may have applications for all of these methods.

The standard method relies on your eye or a batten to judge the application and removal of the fairing compound. It is the method most often used, but requires some experience and/or a good eye to fair very large areas efficiently.

Warning! The dust generated from fairing can make it the dirtiest and one of the most hazardous operations in the boat shop. An appropriate dust mask and eye protection should always be worn. Wear appropriate protective clothing and keep your work area well ventilated. Refer to the safety information in the WEST SYSTEM User Manual & Product Catalog and on all product labels. Read and follow all power tool safety information.

The notched trowel method is a variation of the standard method that makes it easier to sand larger areas. It also relies on your eye to judge the application of the fairing compound.

The batten guide method involves more steps than the standard or notched methods, but offers a more efficient application of the fairing compound.

The template guide method, similar to the batten guide method, is useful when the surface must describe a specific shape very accurately. It is often used to produce accurately faired keel and rudder foils.

14.3.1 Standard method

This method requires you to judge the application of the fairing compound visually and with the aid of a batten. You may need to repeat the process several times to reach a fair surface; however, you should become more efficient with practice.

1. Be sure surfaces to be coated are clean, dry and sanded. Clean contaminated fiberglass or metal surfaces with solvent before sanding. Sand or grind metal surfaces with a coarse grit to remove oxidation and provide a texture for the epoxy to key into. Before coating, identify the low areas by feel or with a batten and estimate the volume of filler required to slightly overfill the void.
2. Wet out the surface with resin/hardener mixture (Figure 14-4). It is a good idea to coat the entire surface or repair area at this time. When coating metal surfaces, you can increase the ultimate adhesion of the fairing material by sanding the wet epoxy mixture

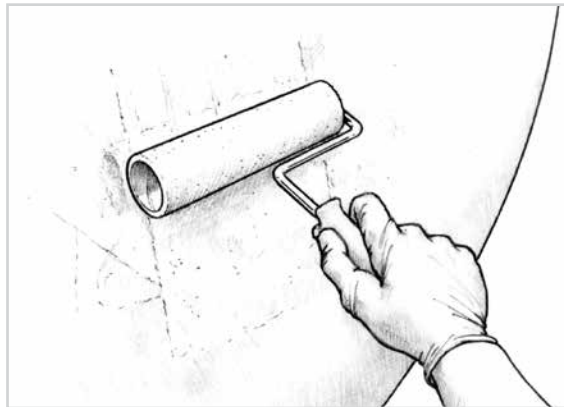

Figure 14-4 Wet out the surface with resin/hardener mixture. To avoid sags, allow the wet-out coat to gel before applying fairing compound.

into the metal with coarse sandpaper. To avoid sagging, allow the wet-out coat to gel before applying the fairing compound. Sanded epoxy surfaces do not need to be wet out.

3. Prepare a fairing compound with epoxy and either 407 Low-Density or 410 Microlight™ filler. Dispense no more than 1/4 of a pot full of resin/hardener to allow room for filler. Mix the resin/hardener together thoroughly. Stir in filler until it reaches a non-sagging, peanut butter consistency.
4. Trowel the mixture on with a plastic spreader. Fill the low areas to just above the fair level so the fairing compound can be sanded back down to fair without having to be refilled. Use the spreader to smooth the compound as close as possible to the desired shape to avoid excessive sanding after the mixture has cured (Figure 14-5). The contour of small areas can often be judged by eye. When filling voids over 1/2" deep, it's best to apply the mixture in two or more layers to avoid excessive heat build up from the exothermic curing reaction. Apply the second layer after the first layer has partially cured.
5. Use a batten to help shape larger areas. After slightly overfilling the area with a spreader, slowly drag a batten across the filled area while bending it to the contour of the surrounding fair areas (Figure 14-6). A slight "Z" or back and forth motion of the batten can help to reduce the drag of the fairing compound. Allow the fairing compound to cure thoroughly before sanding.
6. With the application of the fairing compound, low areas have now become high areas. Sand these areas down to fair using the techniques for overall fairing. Continue to check for fairness as you sand.

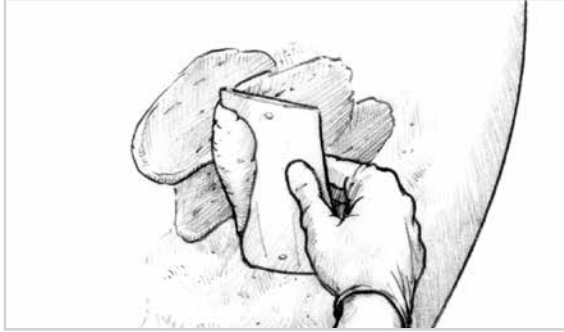

Figure 14-5 Use a spreader to apply fairing compound, and slightly overfill the area. Shape the mixture to blend with the surrounding contour.

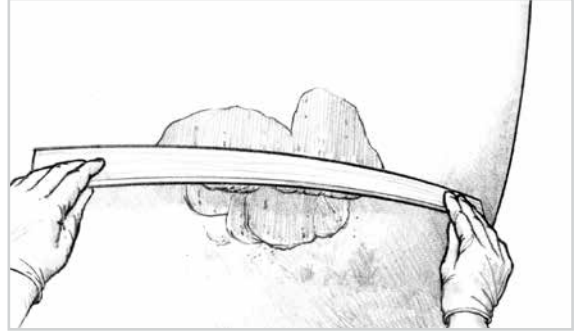

Figure 14-6 On large areas, use a batten to shape the compound after applying it with a spreader

7. Fill and sand any low areas you find as many times as necessary until you are satisfied with the overall fairness. When refilling areas, it is not necessary to re-coat the surface with unthickened epoxy unless you've sanded through the first coating into the original surface.

14.3.2 Notched trowel method

When fairing large areas that require a lot of filling, such as a steel or aluminum hull, it may be easier and more economical to divide the process into two stages. The notched trowel method helps to eliminate much of the sanding time required during the early part of the fairing process by reducing the volume of fairing compound to be sanded. The first layer of fairing compound is applied with a notched spreader to leave a pattern of ridges. Before starting the procedure, use a batten to determine the depths of the areas to be filled and cut the length of the notches in the spreader to match the deepest area.

1. Be sure surfaces to be coated are clean, dry and sanded. Clean contaminated fiberglass or metal surfaces with solvent before sanding. Sand or grind metal surfaces with a coarse grit to remove oxidation and provide a texture for the epoxy to key into.
2. Wet out the surface with resin/hardener mixture (Figure 14-4). Coat the entire surface or repair area at this time. To avoid sagging, allow the wet-out coat to gel before applying the fairing compound. Sanded epoxy surfaces do not need to be wet out.
3. Prepare a fairing compound with epoxy and either 407 Low-Density or 410 Microlight™ filler. Dispense no more than $\frac{1}{4}$ of a pot full of resin/hardener to allow room for filler. Mix the resin/hardener together thoroughly. Stir in filler until it reaches a stiff, peanut butter consistency.
4. Apply the fairing compound with the notched spreader (Figure 14-7). Hold the spreader at a higher angle to leave deeper ridges on the lowest areas and at a lower angle to leave shallower ridges on the higher areas. The tops of the ridges should be slightly above the finished fair level. Allow the fairing compound to cure thoroughly.



Figure 14-7 Apply the fairing compound with the notched spreader. Control the height of the ridges by the angle you hold the spreader.



Figure 14-8 Trowel a second layer of fairing compound over the surface to fill the grooves after the ridges have been sanded fair.

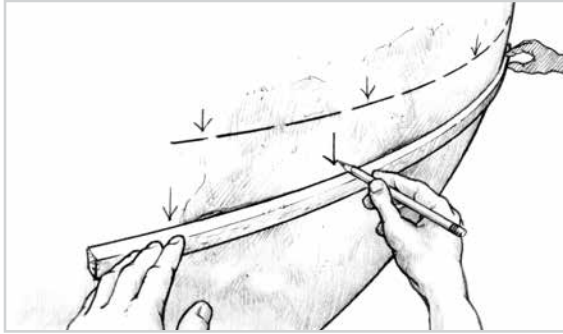

Figure 14-9 Use a long batten to locate the high and low areas and judge the amount of fairing compound required

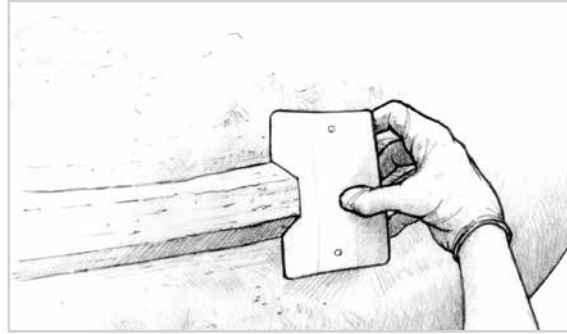

Figure 14-10 Use a spreader notched to the shape of the ridge to shape the mixture.

5. Sand the ridges fair. The ridges of fairing compound are much easier to sand than solid material.
6. Prepare the surface for bonding. Use a wire brush to rough up the exposed surface of the fairing compound within the grooves.
7. Trowel a second layer of fairing compound over the surface to fill the grooves (Figure 14-8). Use a smooth-edged spreader held firmly against the surface to drag away excess compound, leaving a smooth surface flush with the faired ridges. Mix the fairing compound for the second layer to the same density as the first layer. Allow the fairing compound to cure thoroughly.
8. Sand the surface smooth. It should require only minor local fairing before barrier coating and finishing as described in the Finishing section.

14.3.3 Guide methods

The standard method for filling low areas is often one of trial and error. Excess fairing material is applied, then removed and often reapplied and removed until a fair level is reached. Skill and experience are required to accurately apply the fairing compound and cut it away to produce a fair surface with a minimum of waste and effort. The batten guide or template guide methods allow you to accurately fill low areas over a very large area, even entire hulls, using a minimum of material and requiring less sanding time.

Ridges of fairing compound are applied across the unfair surface and a batten or templates are pressed into the ridges. When cured, the cast batten or template profiles provide guides for the application of the remaining fairing compound. A batten laid across the guides accurately controls the level of the fairing compound applied between the guides, in much the same way concrete is leveled between two forms to build a sidewalk. The number of guides required depends on the size and shape of the surface. On flat or simple curved areas like a hard chined hull or a fin keel, one to three guides may be enough to describe the surface. On curved surfaces, a number of closely spaced guides may be necessary to accurately describe surface. A single guide may be placed in an unfair area for general reference or many may be applied over an entire hull in a regular grid pattern for more precise application.

14.3.4 Batten guide method

The batten guide method uses a flexible batten to cast an impression in the ridge of fairing compound. The resulting profile is determined by the stiffness of the batten and the batten's points of contact with the unfair surface. The batten should be a suitable stiffness for the curve of the fairing area. This procedure may require at least two people to support and accurately position the batten.

1. Prepare the area for bonding. Remove all paint. Wire brush the entire surface of external keels to remove any contamination and to expose fresh iron or lead. Sand the surface of internal keels or hulls to remove loose fillers and gelcoat and expose solid fiberglass laminate. Dry the surface if necessary, using a hot air gun, hair dryer or heat lamp.

2. Determine and mark the locations for the guides. If you are fairing a curved surface like a hull, you may need to provide at least three parallel profile guides to describe the curve. Curves with a smaller radius and complex shapes may require more or closer spaced guides. Use a long batten to locate the high spots and determine how much fairing compound will be required to fill the low areas to a level above the bottom of the batten. Mark the high spots where the batten touches the surface (Figure 14-9).
3. Wet out a 2"–3" wide strip at each guide location. If you are working with a lead or metal keel, wire brush the surface while the epoxy is still wet for a better bond. Allow the epoxy to gel.
4. Apply a 1"–2" wide ridge of fairing compound to the surface at each guide location. Use the same mixture of 105 Resin-based epoxy thickened with 407 or 410 filler, thickened to a stiff, peanut butter consistency, that will be used to fill between the guides. Trowel on the fairing mixture with a plastic spreader, and then use a spreader notched to the shape of the ridge to shape the mixture (Figure 14-10). Cut the notch deep enough to equal the height of the ridge at the lowest area of the surface. Tilt the spreader as necessary to adjust the height.
5. Cover the ridges with strips of 879 Release Fabric. Press the fabric lightly to the surface. Do not press hard enough to flatten the ridges. Tape the fabric in place if necessary.
6. Press the batten into the ridge of thickened epoxy until it contacts the high spots in the surface. Push the batten into the ridge. Apply pressure only where the batten touched the

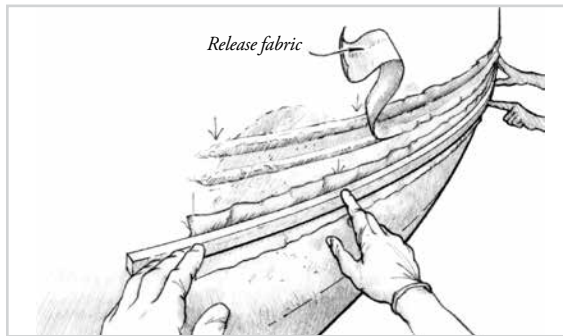

Figure 14-11 Push the batten into the ridge. Apply pressure only where the batten touched the high spot you marked earlier.

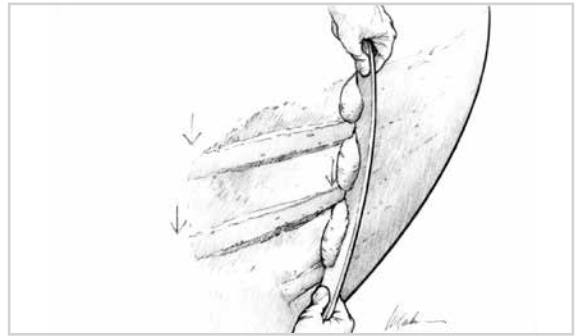

Figure 14-12 Drag the batten along the guides, removing excess mixture and leaving the surface between the guides smooth and level with the

high spot you marked earlier (Figure 14-11). If an area of the epoxy ridge is too low to contact the batten, squeeze the sides of the epoxy ridge together under the fabric so that it is forced up to contact the batten. When you're satisfied, carefully remove the batten without disturbing the ridge or the fabric. Repeat the process for each batten guide and allow the epoxy mixture to cure thoroughly.

7. Remove the release fabric strips and mark the center of the batten impression with a permanent felt marker to act as a sanding indicator. Sand the ridges on either side of the batten impression flush with the center. Avoid sanding into the profile. You should be left with smooth bands of fairing compound that will be used as guides to accurately apply the remaining fairing material.
8. Wet out the surface between the guides with epoxy. Allow the coating to gel.
9. Apply a layer of 105 Resin based epoxy thickened with 407 or 410 filler to the surfaces between the profile guides. Use the same filler and filler consistency that was used to make the guides. Use a plastic spreader to apply and smooth the mixture slightly higher than the guides.
10. Shape the fairing mixture before it begins to gel, using an appropriate batten. With the batten held perpendicular to and pressed to the guides, drag it along the guides. The batten will follow the guide profiles, removing excess mixture and leaving the surface between the guides smooth and level with the guides (Figure 14-12). To give yourself

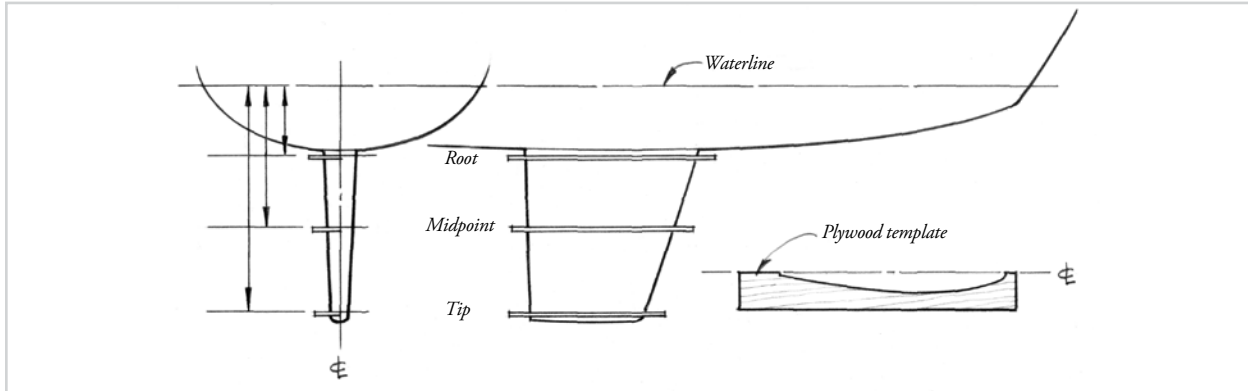

Figure 14-13 Obtain the profiles for three locations on the keel: the root (top of the keel near the hull attachment point), the midpoint and the tip of the keel.

adequate working time in warmer temperatures, use 206 or 209 Hardener or fill just one section at a time. Allow the fairing mixture to cure thoroughly.

11. Sand the cured surface fair, being careful not to sand through the indicator you marked on the top of the guide. Use battens to check for fairness in both directions. Fill any remaining low areas again when cured. Repeat as necessary until you are satisfied with the shape and fairness of the surface.
12. Repeat the process on all areas to be faired. When you are satisfied with the fairness and smoothness, apply epoxy barrier coats and finish as described in the Finishing section.

A variation of the previous method is to apply fairing compound to a large area. Lay strips of release fabric on the surface in several locations, and then press a batten to the surface at each location before the mixture begins to gel. If a thick enough layer of fairing compound is applied, the batten will leave a fair profile indentation in the fresh mixture. When the mixture cures, remove the strips and use the batten profiles as sanding guides. This method reduces the number of steps in the procedure, but requires more sanding.

14.3.5 Template guide method

This method is similar to the batten guide method except that a template describing a specific profile is used to shape the guide rather than a batten. Although a batten-generated profile may be fair, the high points of the unfair surface will determine the profile. Template profiles may be lofted from offsets (See Appendix A) or transferred from an existing surface (See Section 14.3.6—*Template Transfer*).

One of the best uses of this method is to improve the efficiency of rudders and centerboards. The following example describes the use of templates to establish foil shaped guides on the surface of a keel and the application of fairing compound between the guides. Although the procedure describes keel templating, the same procedure applies to rudders or any other lofted shape. This procedure may require at least two people to support and accurately position the templates.

1. Transfer the full size profiles to ½" A/C-grade plywood (Figure 14-13). Cut out the three templates with a band saw or saber saw and sand the edges of the foil shape carefully to eliminate any bumps or unfairness. Mark the keel's centerline on each end of the template. Seal the profile edge of the templates with a coat of epoxy and sand them smooth after the epoxy cures.
2. Prepare the area for bonding. Remove all paint. Wire brush the entire surface of external keels to remove any contamination and to expose fresh iron or lead. (Be sure to wear an appropriate dust mask, especially when sanding or wire brushing lead.) Sand the surface of internal keels (or hulls) to remove loose fillers and gelcoat and expose solid fiberglass laminate. Dry the keel using a hot air gun, hair dryer or heat lamp.

Locate and mark the centerline on the leading edge and, if necessary, the trailing edge of the keel. Mark the template locations on both sides of the keel. Check the keel's profile

- with the templates to locate any high spots and to gauge how much fairing compound to apply to the low areas. Grind down or plane off excessive high spots.
3. Wet out 2"–3" wide strips at the template locations with epoxy. If you are working with a lead or metal keel, wire brush the surface while the epoxy is still wet for a better bond. Allow the epoxy to gel.
 4. Apply a 1"–2" wide ridge of epoxy/407 or 410 filler mixture (thickened to a stiff, peanut butter consistency) to the surface at each template location. Use a plastic spreader to trowel on the fairing mixture slightly thicker than the finished profile. A spreader notched to the shape of the ridge is helpful to shape the mixture.
 5. Cover the ridges with a strips of 879 Release Fabric to keep the fairing mixture from sticking to the template. Lightly press the release fabric to the ridge. Do not press hard enough to flatten the ridge.
 6. Push the templates into the soft mixture to make an impression of the exact keel profile at each template location. To gauge the depth of the impression (height of the profile), push the template into the mixture until the centerlines marked on the template match the centerlines marked on the leading and trailing edges of the keel (Figure 14-14). If an area of the ridge is too low to contact the template when it is properly aligned, squeeze the material under the release fabric upward so it comes in contact with the template. When you're satisfied, carefully remove the template, leave the release fabric in place, and allow the mixture to cure thoroughly.
 7. Remove the release fabric and mark the center of the template impression with a permanent felt marker to act as a sanding guide. Sand the ridges on either side of the template impression flush with the profile. Avoid sanding into the profile. You should be left with smooth bands of fairing compound at the root, midpoint and tip of the keel that will be used as profile guides to accurately apply the remaining fairing material. Use the templates to check the profiles and sand or add filler to the profile as necessary to match the template.
 8. Wet out the surface between the guides with epoxy. Allow the coating to gel.
 9. Mix enough 105 Resin-based epoxy thickened with 407 or 410 fairing compound to fill the area between two of the profile guides. Use the same filler and filler consistency used to make the guides. With a plastic spreader or custom spreader, apply the mixture to the middle area of the foil. Leave the mixture higher than the guides. See Appendix A for information on mixing and applying large quantities of fairing compound.
 10. Lay a precut piece of release fabric over the fairing compound. The fabric should be large enough to cover the entire area from guide to guide. Using a length of 1½" diameter PVC pipe cut to span two of the guides, shape the fairing mixture flush with the guides. Beginning in the middle of the foil, roll the pipe back and forth, as you would a rolling

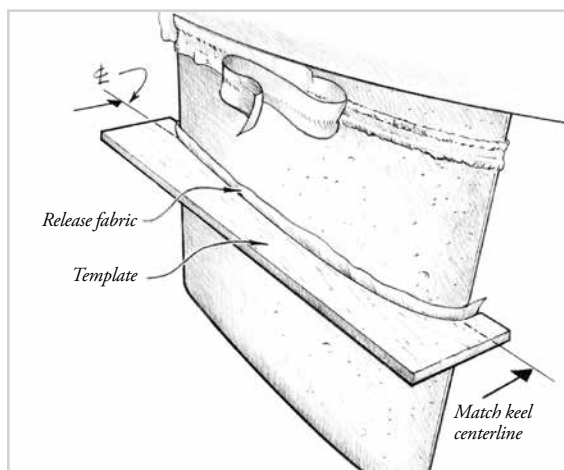

Figure 14-14 Push the batten into the ridge. Apply pressure only where the batten touched the high spot you marked earlier.

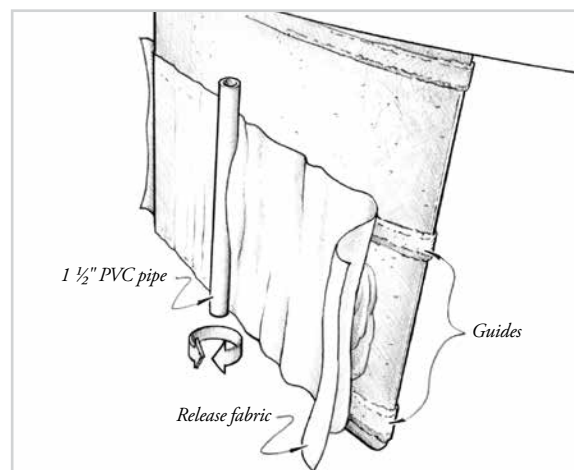

Figure 14-15 Drag the batten along the guides, removing excess mixture and leaving the surface between the guides smooth and level with the

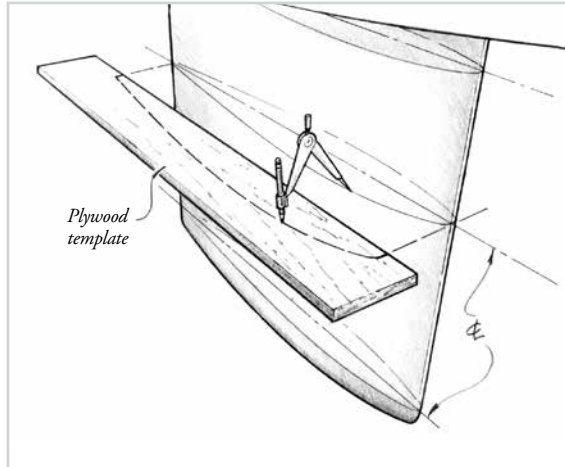

Figure 14-16 Prepare a rough plywood template scribed to within 1/4" of the profile you wish to transfer

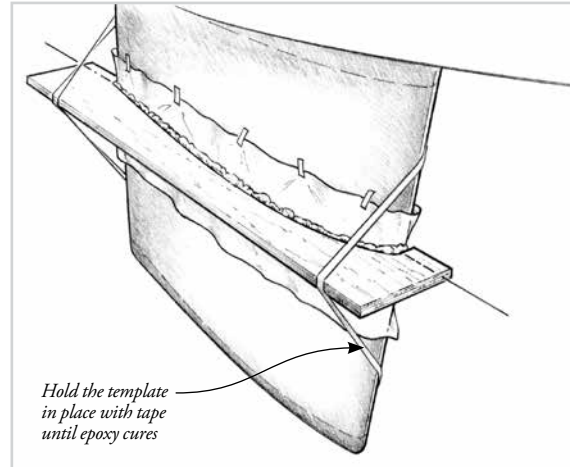

Figure 14-17 Press the template in place against the surface until the thickened mixture makes contact with the surface everywhere along the profile.

pin, forcing fairing compound under the release fabric toward the leading and trailing edges of the foil (Figure 14-15). Adjust the angle of the pipe as you approach the edges of the foil to finish with the pipe parallel to the leading and trailing edges. With the proper amount of fairing compound, a small amount of excess will squeeze from the leading and trailing edge. To give yourself adequate working time in warmer temperatures, use 206 or 209 Hardener. Allow the fairing mixture to cure thoroughly.

11. Remove the release fabric. Repeat the process on the remaining areas. Fill any large remaining low areas using the same procedure after the fairing compound has cured. Repeat as necessary until you are satisfied with the shape and fairness of the surface.
12. Sand the cured surface as necessary. It should require only minor local fairing. When you are satisfied with the fairness and smoothness, apply an epoxy barrier coat and finish as described in the Finishing section.

14.3.6 Template transfer

Template transfer is a method of casting a template profile of an existing shape, using its surface as a mold. The technique has a variety of uses. In the keel fairing situation above, the transfer method can be used to transfer the shape of one side of an existing keel to the opposite side to make the keel symmetrical or it can be used to transfer the shape of one keel or hull to another. The technique can also be used to cast an accurate hull profile to build bunks for cradles or trailers, or any similar situation that requires a shape to be accurately duplicated. The following procedure describes the transfer of a keel foil shape. For accuracy, templates should be transferred in at least two or three locations on the keel.

1. Determine the template transfer locations on the keel. To prevent the template from bonding to the keel, tape a strip of plastic over the area to be cast. (A smooth surface may be waxed to prevent bonding. Apply several coats of paste wax to act as a mold release. Be sure the surface has no recesses that would allow the epoxy to "key" into the surface.)
2. Prepare a rough plywood template scribed to within 1/4" of the profile you wish to transfer (Figure 14-16). Cut the template from 3/8" or 1/2" plywood or particle board several inches longer than the foil. Prepare a method to clamp or brace the template in position against the surface.
3. Wet out the profile edge of the plywood (the edge facing the surface) with epoxy. Apply a bead of 105 Resin-based epoxy thickened with 406 or 404 mixture (thickened to a stiff, peanut butter consistency) to the profile edge of the plywood. The bead should be high enough to bridge any gaps between the template and the foil.
4. Press the template in place against the surface until the thickened mixture makes contact with the surface everywhere along the profile (Figure 14-17). Use duct tape or masking

tape to brace the template in position. Fill in any gaps or displaced mixture and allow the mixture to cure thoroughly.

5. Carefully mark the leading and trailing edge centerlines on the template. Remove the clamps or braces. Remove the template from the surface. Sand the ridges that squeezed from the edge to make both faces of the plywood smooth. Repeat the procedure in the other transfer locations.

14.4 Local fairing

When the difference between high and low areas is reduced by overall fairing (either by sanding down or filling up) or if your hull is generally fair to begin with, you can begin to concentrate on local fairing. Local fairing may be done with smaller sanding blocks, an orbital sander or an air file, using 80-grit sandpaper. It is not necessary to use sandpaper finer than 80-grit. Finer sanding will be done after the final coating. The object is to remove minor bumps or flaws and leave a smooth even texture over the entire surface. A shorter batten may be useful at the early stages of local fairing, but as you continue to eliminate the minor bumps, the batten should become less and less useful.

This is the stage where you rely most on your eye to tell you what is fair. A light held close to the surface will cast long shadows that can help you detect slight surface variations. A clear bulb will cast sharper, more detailed shadows than a frosted or fluorescent bulb. Moving the light around to cast shadows from different directions will help you to locate bumps and voids and determine their height or depth. Fill voids with a thin layer of fairing compound if necessary. Rub your hand lightly over the surface in different directions to detect minor flaws that may not be apparent to your eye. As the surface becomes smoother, your fingertips may be the final judge of fairness. How far you continue with local fairing depends on your ability to detect flaws and how critical you are. Keep in mind that flaws that seem insignificant in a dull 80-grit finish will be more noticeable in a glossy finish, especially a dark colored glossy finish.

After the fairing is completed, fiberglass fabric can be applied to the surface if desired. Fabric is often used to reinforce the structure and/or to provide abrasion resistance to the surface. Refer to the current WEST SYSTEM *User Manual & Product Guide* for details on applying fiberglass cloth.

Note! An epoxy barrier coat is required over sanded 410 Filler, if you are going to apply a solvated coating over the faired surface. Solvents in these coatings can affect 410 Filler and result in print through. An epoxy barrier coat is recommended over sanded 407 Filler to provide a consistent non-porous surface for finish coatings.

15 Finishing

Applying an epoxy barrier coating is the last step in the fairing process and the first step in the finishing process. It is included in the Finishing section because an epoxy barrier coating is widely used as an interface between substrates and paints and varnishes even when fairing is not required. Epoxy bonds to a wide range of materials better than most finish coatings, it is compatible with a wide range of finish coatings, and the stability of an epoxy base helps finishes to last longer than they would over the substrate alone. The combination of an epoxy barrier coating topped with a durable finish coating provides a very effective finish system.

15.1 Epoxy barrier coating

The object of epoxy barrier coating is to build up an epoxy layer that protects the substrate from moisture. In doing so it stabilizes the substrate and provides a smooth stable base for the finish coating needed for UV protection.

For an effective moisture barrier on most exterior surfaces, apply a minimum of three coats (about 10 mils) of WEST SYSTEM Epoxy. Moisture protection will increase with additional coats, up to six coats or about a 20 mil thickness. A minimum of six coats is recommended on fiberglass hulls below the waterline. See Section 13.2.

For best results, apply the coatings at or above room temperature. Epoxy will be thinner and spread more easily in warmer temperatures. Adding solvents to thin WEST SYSTEM Epoxy compromises its strength and moisture resistance, and is not recommended. Additives or pigments should not be added to the first coat.

Disposable, thin urethane foam rollers, such as WEST SYSTEM 800 Roller Covers, are essential for applying epoxy. They allow you greater control over film thickness, leave less stipple than thicker nap-type roller covers, and the epoxy does not build up and cure as quickly on the cover. When used with an 801 Roller Frame, the covers may be cut into narrower widths to reach difficult areas or for coating long narrow surfaces like stringers.

Complete all fairing and cloth application before beginning the final coating. Allow the temperature of porous surfaces to stabilize before coating. Otherwise, as the material warms up, air within the porous material may expand and pass from the material through the coating (out-gassing) and leave bubbles in the cured coating. For most situations that will be coated with an opaque finish, 105 Resin with 205 or 206 Hardener are recommended.

When extra working time is needed in warmer temperatures, use 105 Resin with 209 Extra Slow Hardener. For clear finishes over wood, use 207 Special Clear Hardener.

While coating, remember that the thinner the film thickness, the easier it is to control the evenness of the film and avoid runs or sags in each coat. Thin coats also reduce the risk of trapped air bubbles in the coating. Fewer thick coats may take less time to apply, but will require more sanding and possibly more time overall.

Apply an epoxy barrier coat as follows:

1. Prepare the surface as necessary. After local fairing, the surface should be immediately ready for bonding. To avoid the possibility of surface contamination, begin the coating operation within 24 hours of final sanding.
2. Mix only as much resin/hardener as you can apply during the open time of the mixture. Pour the mixture into a roller pan as soon as it is mixed thoroughly.
3. Load the roller with a moderate amount of the epoxy mixture. Roll the excess out on the ramp part of the roller pan to get a uniform coating on the roller.

4. Transfer the epoxy evenly to a small area. Roll lightly and randomly over an area approximately 2' × 2' (Figure 15-1).
5. Work the epoxy from thicker areas into thinner areas to spread it into a thin even film. Increase pressure slightly as the roller dries out. Expand the coverage area if necessary to thin out the film. Avoid working air into the coating by rolling too vigorously.
6. Finish the area with long, light, even strokes to reduce roller marks. Overlap the previously coated area to blend both areas together.
7. Coat as many of these small working areas as you can with each batch. If a batch begins to thicken before it can be applied, discard it and mix a fresh, smaller batch.
8. Tip off each batch, as soon as it is applied, by dragging a roller cover brush lightly over the coating in continuous, parallel, overlapping strokes. Press hard enough to smooth the stipple and remove air bubbles, but not hard enough to remove any of the coating (Figure 15-2). Overlap and blend in the edge of the previous batch. The proper film thickness will flow out smooth and level, even on vertical surfaces. See Appendix A or the 800 Roller Cover package for information on making a roller cover brush.

15.1.1 Re-coating

Apply second and subsequent coats of epoxy following the same procedures. Make sure the previous coat has cured firmly enough to support the weight of the next coat. The ideal time to re-coat is when you can still leave a finger print in the previous coat, but it will no longer come off on your finger. Epoxy will chemically bond to a previous coat of epoxy that has not fully cured. Fully cured epoxy must be prepared by washing (see amine blush below) and sanding to achieve a mechanical bond with the next coat. To avoid sanding between coats, apply all of the coats in the same day (or apply each coat before the previous coat has fully cured). Tip off each coat in a direction perpendicular to the previous coat (e.g., first coat vertical, second horizontal, third vertical). After the final coat has cured thoroughly, wash and sand or wet-sand it to prepare for the final finish. If you are unable to apply all of the coats in the same day, allow the last coat to cure thoroughly and prepare the surface for re-coating by first removing the amine blush.

On very large coating projects consider whether the job can be accomplished in one working day and, if necessary, how the coating operation could be efficiently split into multiple days. If, for example, you are applying six coats of epoxy to a large hull, it is a good idea to apply all six coats to half the hull on one day and six coats to the other half on the next day, rather than applying three coats to the entire hull on each day. Instead of having to wash and sand the entire hull to prepare for the next coat, you need only wash and sand the small overlap area at the edge of the first half. The project could be split into three or four day session depending on the number of helpers available and the conditions you are working in. The type of hardener, film thickness, temperature, humidity all affect epoxy's cure time and your re-coating schedule. Refer to Section 16 for detailed information on handling epoxy.

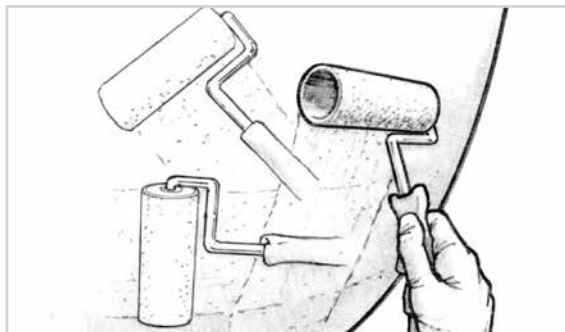

Figure 15-1 Using a foam roller, apply the epoxy and spread it into a thin even film.



Figure 15-2 Tip off each batch, as soon as it is applied, by dragging a roller cover brush lightly over the wet surface.

Amine blush

Amine blush is a byproduct of the epoxy curing process and can appear as a wax-like film on some cured epoxy surfaces. It is more noticeable on thicker films, cured in cool humid conditions. 207 Special Clear Hardener is blush free.

The blush is water soluble and can easily be removed, but can clog sandpaper and inhibit subsequent bonding if not removed. To remove the blush, wash the surface with clean water and an abrasive pad, such as 3M Scotch Brite™ 7447 General Purpose Hand Pads. Dry the surface with plain white paper towels to remove the dissolved blush before it dries on the surface. After washing with the abrasive pad, the surface should appear dull. Sand any remaining glossy areas with 80-grit sandpaper. Wet-sanding the surface will also remove the amine blush. If a release fabric is applied over the surface of fresh epoxy, all amine blush will be removed when the release fabric is peeled from the cured epoxy.

Epoxy surfaces that have not fully cured may be bonded to or coated with epoxy without washing or sanding. Before applying coatings other than epoxy (paints, bottom paints, varnishes, gelcoats, etc.), allow epoxy coated surfaces to cure fully, then wash and sand or wet-sand.

15.2 Final surface preparation

Preparation for the final finish is just as important as it is for re-coating with epoxy. The object of the final sanding is to smooth flaws in the epoxy coating and provide the appropriate “tooth” for the finish coating to key into. Allow the final epoxy coat to cure thoroughly and sand it to a smooth finish by either dry or wet sanding. Wet sanding will automatically remove the amine blush and it reduces sanding dust. If you prefer dry sanding, remove the amine blush (as described above) before beginning to sand.

The amount of sanding required will depend on how smoothly you applied the final epoxy coatings and which finish coating you choose. Since the epoxy is harder to sand than wood or fairing compound, power sanders can save a lot of work over hand sanding. An orbital or reciprocating sander with 80- or 100-grit paper works well for the initial sanding if the surface has stipple, sags or other unevenness. When the surface has reached an overall smoothness, switch to finer grits. Note that a dual-action (DA) orbital sander with coarser grit (e.g. 80-grit) will produce the same degree of smoothness as a reciprocating sander or hand sanding with a finer grit (e.g. 100-grit).

Complete the sanding with the appropriate grit for the type of coating to be applied. If a high-build or filling primer is to be applied, 80–100-grit is usually sufficient. 120–180-grit paper may be adequate for primers and high-solids coatings. Sanding with 220–400-grit paper will result in a high gloss finish for most paints or varnishes. Grit finer than this may not provide enough tooth. Keep in mind that light colored surfaces do not show sanding scratches as easily as dark surfaces. Sand to a finer grit finish under dark paints and clear finishes over dark wood. Always refer to the coating manufacturer’s specifications for the surface finish recommended for a particular coating.

Refer to Appendix A for more information on sanding equipment and abrasives.

When you are satisfied with the smoothness, rinse the surface with fresh water. The rinse water should sheet evenly without beading or fisheyeing, indicating that there is no surface contamination. Dry the surface with plain white paper towels and allow to air dry completely before coating. To reduce the possibility of contamination, it is a good idea to apply the finish coating within 24 hours of the final sanding.

15.3 Finish coatings

We’re using the term “finish coating” to distinguish it from the epoxy “barrier coating” and to include all coating materials (pigmented and non-pigmented) that can be applied over an epoxy barrier coat to form a protective system. Although modern linear polyurethane coatings are chemically quite different than traditional coatings, the term

paint is generally used to refer to all pigmented coatings. The term varnish is often used to refer to all clear coatings. However, manufacturers and others distinguish between traditional varnishes and modern clear urethanes or clear polyurethanes.

Traditionally, paints and varnishes have been called on to protect structures from corrosion, oxidation and other forms of deterioration from exposure to air, sunlight, and water. However, paints and varnishes are not as effective for moisture protection as epoxy. If buried in the ground, used only on interior surfaces or on surfaces otherwise protected from sunlight, an epoxy moisture barrier will remain effective indefinitely. However, under prolonged exposure to sunlight, an epoxy coating, like many other plastics, will chalk, turn yellow, and eventually break down. It is not intended to be an exposed finish coating. When applied over an epoxy barrier coat, the function of a finish coating like paint or varnish is to decorate the surface and protect the epoxy from sunlight. In doing so, the finish coating extends the life of the epoxy moisture barrier, which, in turn provides a stable base that extends the life of the finish coating. Together the two form a protective system far more durable than either coating by itself.

The ideal finish coating should not only look good and provide UV protection, it should be long lasting, tough, safe, easy to use, affordable, and compatible with epoxy. This section discusses these characteristics and the different types of coatings, to help you select the one best suited to your project.

15.3.1 Characteristics of coatings

Over the years, advances in chemistry have improved the durability of finish coatings and the protection they offer. Paint and varnish have evolved into an extensive and increasingly confusing family of coatings and coating systems. When evaluating different coatings for your project, several basic coating characteristics should be considered.

UV protection

Protection from sunlight is a primary consideration in the selection of a finish coating. The ultraviolet portion of sunlight (UV) is the primary catalyst in the degradation of epoxy and other plastics. The following factors affect a coating's ability to provide UV protection.

Pigmented vs clear coatings—Any coating that adheres to the surface and contains enough pigment will protect the epoxy barrier substrate from UV, for a time. Pigmented coatings work because opaque pigments reflect both visible and ultraviolet light before it passes through the coating film. Clear coatings and varnishes, on the other hand, are designed to allow light to pass through the film to the substrate and back out. They depend on “ultraviolet absorbers” to selectively trap radiation in the UV wavelength in the coating film before it reaches the barrier substrate. Without absorbers, UV would soon break down the substrate, causing the coating film to lose adhesion. UV absorbers alone are not as effective as pigments in blocking UV. Consequently, even the best clear coatings do not last as long as pigmented coatings, and require more frequent re-coating. UV absorbers are added to pigmented and clear coatings for their own durability. For both types of coatings, long term UV protection of the barrier coat depends on how well the finish coating itself resists UV and keeps its pigments, or its shield of UV filters on the surface of the epoxy barrier coat.

Glossy vs matte finishes—Surface gloss is an important contributor to the UV resistance of both pigmented and clear coatings. A high gloss finish reflects a higher proportion of the light hitting the surface than a dull surface. Coatings are often rated or promoted by their ability to retain their gloss. Chalking, or loss of gloss, is one of the first indications that a finish is breaking down. As a surface loses its gloss, it reflects a smaller proportion of light, absorbs more UV, and the pace of the breakdown accelerates. Matte or satin versions of the same type of coating have a much shorter life than gloss versions, and are generally limited to interior surfaces, unless the surface is protected from UV in other ways. UV damage is cumulative. Covering when not in use or storing indoors to limit the hours of exposure will extend the life of matte and gloss finish coatings.

Light vs dark colors—The shade and color of the finish is also a factor in UV resistance. Darker shades absorb more ultraviolet than lighter shades, and some colors absorb more ultraviolet than others. White reflects more light and will last longer in sunlight than any

color. It reflects all parts of the spectrum better, including infrared. This means the surface will remain cooler than a surface painted a dark color. All other things being equal, a white (especially a glossy white) coating will have the greatest longevity. A flat black coating will have the least. Cool colors (blues and greens) will last longer than warm colors (reds and browns). Clear coatings over light colored woods will outlast the same coating over dark colored woods. Remember! Sunlight is the enemy of epoxy.

Adhesion

Paint adhesion relies on the mechanical grip of the paint keying into the sanding scratches in the epoxy's surface. Big scratches provide the best adhesion, but they may show through the finish. As a general rule, use no coarser than 80-grit with a mechanical sander and no coarser than 100-grit when hand sanding. The final grit you use depends on the type of paint and how thick a film will be applied. Try to use the coarsest paper that will not show scratches through the paint.

Surface contamination is a common cause of adhesion problems. After an epoxy barrier coat is properly sanded, protect the surface from all potential sources of contamination such as engine and heater exhaust, hand and finger prints, and rags cleaned or dried with fabric softeners. To reduce the possibility of contamination, begin the final coating application as soon as possible after the barrier coat preparation.

Compatibility

Most types of coatings are compatible with epoxy. Thoroughly cured epoxy is an almost completely inert hard plastic. This means most paint solvents will not soften, swell or react with it. However, it is still a good idea to build a test panel to assure coating compatibility and work out application procedures before final application on a project. The test should duplicate the barrier coat finish, finish coating materials, application procedure and shop conditions. A lot of variables can affect the success of the final coating. Working out the bugs beforehand can save money, time and effort.

Note: Some types of one-part polyurethane coatings may not cure properly over epoxy. Incompatibility may be a result of a specific polyurethane catalyst reacting with or being affected by amine blush on the surface of the epoxy coating. Cure mechanisms vary from brand to brand. If a specific brand is incompatible, try a different brand or a different type of coating or use 207 Hardener. 207 Hardener is compatible with most coatings.

Hardness

The hardness of a coating is another factor to consider in selecting a finish. Manufacturers refer to coating hardness in terms of a "pencil" hardness scale: 6B (the softest), to HB (the middle), to 6H (the hardest). Harder coatings are more resistant to wear and last longer than soft finishes. It is easier to remove flaws or scratches in harder finishes by rubbing or buffing. (Some coatings may harden enough to buff only after weeks or months of curing.)

The biggest advantage of a hard glossy coating is that it is easier to keep clean. Softer or more flexible coatings hold dirt easier and require more abrasion to clean. The more they are abraded, the more dirt they hold, and the more abrasion is required to clean them the next time. The trade off is that too hard a finish can chip or crack if it's applied to a flexible surface.

Application considerations

The method of application is another important factor in the selection of a coating. Spray application is preferred if achieving the smoothest possible finish is the primary goal, but in some situations rolling, brushing or a combination of rolling and brushing may be your preferred or only choice. Spraying depends on access to proper equipment and an environment where overspray and solvent fumes can be controlled. Safety and health considerations are a major concern when spraying, especially with coatings like linear polyurethanes which require the applicator to wear special breathing equipment.

Roller/brush application is a good alternative to spraying. The same technique described for applying epoxy in *Epoxy Barrier Coating* (Section 16.4.6) can be used to achieve a reasonably smooth finish with most coatings. There are a number of advantages to this method. The cost of transporting large projects to the nearest suitable location for spraying can be prohibitive. Most coatings are much less hazardous when they are not atomized

and overspray is eliminated, allowing you to work wherever temperature, humidity and airborne contaminants can be controlled or at least tolerated.

Automotive finishes are limited to spray application, but most marine or architectural coatings can be applied by spraying or by rolling or brushing. Marine linear polyurethane (LP) systems require different catalysts for brushing and spraying. Additional reducers and additives are available to control the rate of cure and other handling characteristics.

Coatings are adjusted to the proper consistency for either spraying or brushing by the addition of reducers or thinners. The amount of reducer/thinner added also affects the film thickness and the rate of cure. They may also soften the surface of some substrates, providing a chemical “bite” that improves adhesion. Reducers and thinners are blends of volatile solvents. Coatings may contain more than 20% solvents, most all of which evaporate into the air. Environmental concerns have restricted or will restrict the use of many of the more hazardous paint solvents. The number of highly solvented coatings is declining and the number of coatings with lower or safer solvents is increasing.

Selecting the right finish coating is becoming increasingly difficult given the changes underway in the coating industries. Marine coatings, architectural coatings, automotive and industrial coatings are all suitable for use over epoxy, although some will be much more suited to an individual project than others.

15.3.2 Coating types

At one time “paint” referred to a protective and decorative coating consisting of a natural oil or resin binder and a solvent (together known as a vehicle), and pigments. When the solvent evaporated, the oils hardened to form a film, with the pigments suspended throughout. Although pigments have stayed pretty much the same, the natural oil and resin binders have been replaced or modified by a variety of synthetic resins and more complex film forming mechanisms.

Modern coatings offer a range of curing systems, handling characteristics and physical properties, from water-based latex to linear polyurethane. As durability and protection increase, cost, health hazards and difficulty of use often increase proportionately. The following types of coatings are listed in order of protection they offer, although physical properties can vary widely within each type. Coatings are commonly identified by the chemical names of their resin/oil and solvent vehicles.

Waterborne coatings

Latex paint is the most common water-borne coating and perhaps the safest and easiest to use of all coatings. Latex paints are compatible with epoxy and they do an adequate job of protecting the epoxy barrier from UV radiation. In many architectural applications latex paint may be the most suitable coating to use.

The number of waterborne coatings is increasing rapidly. In response to restrictions on volatile organic compound (VOC) emissions, massive research and development projects are currently underway to improve the protection and durability of waterborne systems. Water offers an obviously cleaner and safer alternative to the aromatics, ethers, esters and aliphatics used as coating systems solvents. Newer waterborne coatings include bottom paints, varnishes and top coats. They should be compatible with epoxy, although few have been available to test for compatibility or durability.

Alkyd finishes

Alkyd resins are a synthetic polymer used as the base for a large family of coatings. They are usually modified with natural oils like linseed, soybean, cotton, or sunflower seed, or with other synthetic polymers like phenolics, acrylics or silicones. Alkyd finishes are one part coatings that cure as a result of solvent evaporation. They have been around for a long time and are among the lowest priced and easiest to use coatings.

They can be applied by brush, roller or spray equipment, and they thin and clean up with relatively safe solvents, like mineral spirits. They may be labeled as enamel, alkyd enamel, marine enamel, acrylic enamel, alkyd modified epoxy, traditional varnish and spar varnish. Within this group are a wide range of coatings with a variety handling characteristics and cured physical properties. Generally, they offer ease of application, low

cost, low toxicity, and easy availability. Their disadvantages are low UV resistance and low abrasion resistance.

One-part polyurethanes

There are two types of one-part finish coatings labeled polyurethane. The first type are urethane modified oils and urethane modified alkyds, which are similar to alkyd coatings in that they cure by oxidation when exposed to air. They also are similar in handling, application and cleanup, but offer much higher performance than traditional alkyd finishes. The second type of polyurethane falls between the solvent evaporation type and the cross-linking type of coating. It relies on solvent evaporation, but cures by a cross-linking reaction when exposed to humidity in the air. This type of polyurethane forms a durable film with good gloss retention and chemical resistance. They may be labeled urethane, polyurethane varnish, or polyurethane enamel. They offer easy application, cleanup and better physical properties than alkyds. They are also more expensive and some may be incompatible with amine cure epoxy systems such as WEST SYSTEM.

Two-part epoxy paint

Epoxy paints are available in one-part and two-part versions. Two-part epoxies offer many characteristics similar to the higher performance polyurethanes. They are durable and chemical resistant, but offer limited UV protection compared to the linear polyurethanes. Epoxy paints are useful as a stain resistant, easy to clean coating for interior surfaces like kitchens and bathrooms or in areas subject to oil or chemical spills.

Two-part polyurethanes

Two-part linear polyurethane (LP) paints offer the most durable protection available. They are two part systems that cure by a cross-linking chemical reaction, initiated when a hardener (or converter) is mixed with the base resin. LP's shrink less than coatings that cure by solvent evaporation. They can be applied in thinner films and they hide more flaws. LP's are available as pigmented or clear coatings and offer excellent UV protection, gloss retention, abrasion resistance, plus compatibility with epoxy. However, they are expensive, require more skill to apply and present a greater health hazard than all other types of coatings.

Two-part polyurethanes contain isocyanates, which are hazardous, especially when sprayed. Spraying requires the use of forced air breathing equipment, making it more suited to professional application. However, good results are possible with roller/brush application at much safer vapor levels. Awlgrip, Interlux and Sterling are manufacturers of marine LP's that offer reducers for both roller/brush and spray application. Although automotive LP coatings are limited to spray application, they offer the same durability and protection as marine versions. They also offer a larger variety of colors (including metallics) and are available at local auto parts stores.

Note! An epoxy barrier coat is required over epoxy/410 Microlight Filler, if you are going to apply a solvented coating over the faired surface. Solvents in these coatings can affect 410 Filler and result in print through. Barrier coating is recommended over sanded epoxy/407 Filler to provide a consistent non-porous surface for finish coatings.

Other coatings

Some coatings are formulated for specific functions—protection in a particular environment, as an interface between substrates and finish coatings or for certain application or handling traits. The following are examples of coatings designed for these kinds of limited applications.

Bottom paint—Bottom paints are available in a variety of formulations. Most bottom paints use copper as the biocide for algae and other forms of fouling. Some paint films are designed to wear away over time (ablative types), exposing fresh copper compounds. Most bottom paint systems are compatible with epoxy and can be applied directly over a prepared epoxy barrier coat. If you are unsure of compatibility or have curing or adhesion problems with a specific bottom paint, use only a primer recommended for that bottom paint over the barrier coat. Follow the recommendations given for preparation of fiberglass surfaces. Other paints, including marine LP's and primers, are not recommended for use below the waterline.

Primers—Many primers are epoxy based because of epoxy’s ability to adhere to a wide variety of materials and its compatibility with a wide variety of finish coatings. Primers are usually not needed to help a paint film bond to epoxy, although interfacing primers may be required with some specialized bottom paints and high-build primers are useful for hiding scratches or flaws in the substrate. If the instructions on your paint or varnish recommend a specially primed surface, follow the recommendations given for fiberglass preparation. Self-etching primers do not work well on an epoxy coating because of epoxy’s chemical resistance.

Polyester gelcoats—Polyester gelcoat is a pigmented version of the resin used to build fiberglass boats and other products. Gelcoat is sprayed into a mold before the glass fabric and resin are applied to provide a smooth pre-finished surface when the part is removed from the mold. It is not often used as a post-production finish coating, but it can be applied over cured and properly prepared epoxy and is useful in some repair situations.

15.3.3 Gelcoat finishes

In answer to questions concerning compatibility and techniques for applying polyester gelcoats over repairs made with WEST SYSTEM Epoxy, we can say epoxy provides an excellent base for polyester gelcoats. The following procedure will assure good adhesion and a well matched repair color. If you have only a shallow crack or scrape that does not extend into the laminate, begin with Step 1. If you have repaired minor cracks or scrapes with epoxy and are ready to proceed with the final gelcoat finish, begin with Step 4. Be sure the epoxy has cured thoroughly. Wash the surface thoroughly with water to remove all traces of amine blush.

1. Remove any surface contaminants such as wax, oil or mold release. Wipe an area at least twice as large as the damaged area with a wax and silicone remover (Dupont Prep-Sol™ #3919S), acetone or appropriate solvent. Dry the area with clean paper towels before the solvent evaporates.
2. Scrape out the cracks or scratches with a 90° “V” shaped scraper to expose clean gelcoat and increase the bonding area slightly. Do not scrape through the gelcoat.
3. Fill the scraped out voids with gelcoat. Mix a small batch of gelcoat without thinners. Trowel the mixture into the voids, leaving it slightly higher than the surface. Allow the gelcoat mixture to cure thoroughly. If the color match is good, wet sand to a 600-grit finish and buff.
Voids can also be filled with Six10 Epoxy Adhesive or 105 Epoxy/406 mixture, cured and sanded, prior to applying gelcoat.
4. Apply tape around the perimeter of the de-waxed area. Mask the area beyond the repair to protect the boat from overspray. If there is a molded body line or corner near the repair, you may want to extend the color patch to that point. The same is true for a painted or vinyl stripe.
5. Sand the additional area out to the tape line with 320-grit paper. This will be the total area to be gelcoated.
6. Determine the gelcoat batch size for the size of the repair—approximately 80 square feet per gallon of gelcoat (20 sq. ft. per qt.).
7. Tint the batch of gelcoat to match the color of the boat. If the boat is fairly new and the manufacturer is still in business, you may be able to get gelcoat that will be a very close color match. If this is not an option, you will need to get the gelcoat from a FRP product supplier. Many marine distributors handle the gelcoats from various resin manufacturers. You will also need pigments to tint the base color to obtain a good match. These pigments are generally available from the gelcoat suppliers. Frequently, local repair yards that do fiberglass repairs will sell these products.

There are gelcoat additives (available through most gelcoat suppliers) that, when used properly, make matching a repair easier. These are clear, low-viscosity resins that are not air inhibited. These products are mixed with the pigmented gelcoat in place of a wax solution to provide a tack-free cured surface. They also provide the added benefit of thinning the gelcoat without changing the color of the cured patch the way acetone

or styrene can. Gelcoat additives are manufactured by Duratec, and Cook Paint and Varnish Company.

Matching the repair color to the color of the boat can be difficult. Most gelcoat colors change as they cure. As you tint the gelcoat to match, apply a small amount of uncatalyzed material to the sanded area surrounding the repair. Use your gloved finger to spread this into a sample the size of a quarter. Wait a couple of minutes for the solvents to flash off. Any color variation will be evident. If the color match is not acceptable, change the color by adding small amounts of tinting pigments. As you adjust the gelcoat color, think in terms of the basic color hues, i.e.; the color needs to be more red, blue, green or yellow. This will help you identify which of the pigments to use. Use very small amounts of the pigments. When the hue is right, adjust the brightness, darker or lighter by adding black or white. It will take much more white pigment to lighten a mixture than it will a small amount of black pigment to darken it. Apply an uncatalyzed smear with each change of color no matter how small. Leave each of these smears on the surface until you have the color as close to the boat color as you can get it. When you are satisfied with the color match, wipe away all of the test smears with acetone or lacquer thinner.

8. Divide the batch into a $\frac{2}{3}$ portion and a $\frac{1}{3}$ portion. Our technique for using the patching additives is slightly different than the manufacturers recommended procedure.
9. Mix the patching additive with equal parts of the $\frac{2}{3}$ portion of the matched gelcoat. Catalyze following the recommendations of the gelcoat supplier. Over or under catalyzation may prevent the product from reaching a proper cure.

Apply this mixed gelcoat to the repair with a spray gun. Apply several light coats, feathering each one farther from the repair area. Allow the solvent to flash off between coats. You may need to apply five or six coats to hide the shadow of the repair. Most gelcoats will cure lighter in color if they are too thin. Most manufacturers recommend a total film thickness of 15 to 20 mils. Avoid applying the gelcoat in two or three heavy coats, which may cause solvent entrapment and improper curing. This may also have an effect on the color of the cured repair.

10. Mix a second batch using the $\frac{1}{3}$ portion of gelcoat and patching additive. This time use about three parts of patching additive with one part gelcoat.

Spray the first coat of this mixture over the previously sprayed area. Then apply two or three more coats of this mixture over the entire area. Extend each coat farther than the previous one, with the last coat out to the tape line. The semitransparent film of lightly tinted clear patching additive will allow the original gelcoat color to show through around the perimeter of the patch. This will help blend any subtle color change into the original gelcoat.

11. Allow the gelcoat to reach a full cure. Pull the tape and sand the tape line smooth. Start with 320-grit wet or dry paper and work up to 600-grit. Sand the surface of the middle of the repair if necessary.
12. Buff the surface with a white, medium-cut rubbing compound. Take your time and do not overheat the surface while buffing. The excess heat can cause a stain that will be very difficult to remove. Finish with a fine compound and wax the area.

There are times when the repair will not match simply because the original gelcoat color has faded. You may need to polish the entire section of the boat to restore the original color.

15.3.4 Paint finishes

Although almost any high-quality marine-grade paint will work, we recommend using one or two-part polyurethane paint systems above the waterline. (Below the waterline, apply bottom paint directly over thoroughly cured WEST SYSTEM Epoxy.) These paints provide ultraviolet protection, have good gloss retention and a durable, abrasion-resistant surface, provided you follow the manufacturer's instructions carefully. Light colors, especially white, are recommended over dark colors. White reflects UV and infrared radiation better than other colors and all other things being equal outlasts other colors. Polyurethanes adhere well to fiberglass surfaces bonded with both polyester and epoxy resins.

Note: seal all areas of sanded 407 and 410 fairing compound with epoxy before applying primers or paints.

It is possible to color match small areas, particularly if they are in fairly inconspicuous locations. However, if you have a large repair, or several smaller repairs over a large area, you may find it easier to repaint the entire hull or deck.

Polyurethanes, just like epoxies, are affected by moisture contamination. This means use caution when painting: don't paint early in the morning or late in the afternoon. Also avoid painting in direct sunlight.

If you've chosen to paint, you will probably be painting the entire hull, deck or cabin top. Begin by inspecting the entire surface. Wipe with a silicone and wax remover (such as DuPont Prep-Sol™#3919-S) to eliminate any trace of mold release agents or wax. It may require two or three washings. Thoroughly abrade the surface to be painted by wet-sanding with 180-grit sandpaper, followed by 220-grit. Follow the paint manufacturer's recommendation for the final grit. Generally, the thinner the paint, the finer the grit of the final sanding. You must remove all glossiness from the surface. Polyurethanes tend to highlight any surface imperfections, rather than hide them. Check for nicks, dings or gouges and repair them as described previously.

After all repairs have been made, wash the entire painting surface with the paint manufacturer's recommended solvent. Follow the manufacturer's mixing and application instructions to the letter. It's far better to apply two or three thin coats than one thick coat.

15.3.5 Final notes

A few paints and varnishes do not cure well over the epoxy. If the coating does not dry in the specified time or flow on evenly, try a different brand or use a primer.

Follow all instructions from the coating systems manufacturer. It is a good idea to make a test panel to evaluate the degree of surface preparation required, and the compatibility and handling characteristics of the finish system.

Be sure to familiarize yourself with the use and handling of WEST SYSTEM Epoxy products by reading the *WEST SYSTEM User Manual & Product Guide*.

For structural repairs to wood or fiberglass, refer to 002-970 *Wooden Boat Restoration & Repair*.

Additional Reading

Fine Boat Finishes by Paul and Marya Butler is an excellent marine oriented guide to materials and techniques used to produce professional quality finishes.

The Gougeon Brothers on Boat Construction discusses many aspects of fairing and includes an extensive chapter on lofting.

16 Using WEST SYSTEM Epoxy

This section is designed to help you understand and safely handle WEST SYSTEM® Epoxy products and to provide the basic techniques used in most repair and building operations. Refer to the WEST SYSTEM *User Manual & Product Guide* for more complete product information.

16.1 Epoxy safety

Epoxyes can be used safely if handled properly. To use WEST SYSTEM Epoxyes safely, you must understand their hazards and take precautions to avoid them.

Hazards

The primary hazard associated with epoxy involves skin contact. WEST SYSTEM resin may cause moderate skin irritation. WEST SYSTEM hardeners are corrosive and may cause severe skin irritation. Resins and hardeners are also sensitizers and may cause an allergic reaction similar to poison ivy. Susceptibility and the severity of a reaction varies with the individual. Although most people are not sensitive to WEST SYSTEM resins and hardeners, the risk of becoming sensitized increases with repeated contact. For those who become sensitized, the severity of the reaction may increase with each contact. The hazards associated with resins and hardeners also apply to the sanding dust from epoxy that has not fully cured. These hazards decrease as resin/hardener mixtures reach full cure. Refer to product labels or Safety Data Sheets for specific product warnings and safety information.

Precautions

1. Avoid contact with resin, hardeners, mixed epoxy and sanding dust from epoxy that is not fully cured. Wear protective gloves and clothing whenever you handle WEST SYSTEM Epoxyes. Barrier skin creams provide additional protection. If you do get resin, hardener or mixed epoxy on your skin, remove it as soon as possible. Resin is not water soluble—use a waterless skin cleanser to remove resin or mixed epoxy from your skin. Hardener is water soluble—wash with soap and warm water to remove hardener or sanding dust from your skin. Always wash thoroughly with soap and warm water after using epoxy. Never use solvents to remove epoxy from your skin.
Stop using the product if you develop a reaction. Resume work only after the symptoms disappear, usually after several days. When you resume work, improve your safety precautions to prevent exposure to epoxy, its vapors, and sanding dust. If problems persist, discontinue use and consult a physician.
2. Protect your eyes from contact with resin, hardeners, mixed epoxy, and sanding dust by wearing appropriate eye protection. If contact occurs, immediately flush the eyes with water under low pressure for 15 minutes. Seek medical attention or advice.
3. Avoid breathing concentrated vapors and sanding dust. WEST SYSTEM Epoxyes have low volatile organic compounds (VOC) content, but vapors can build up in unvented spaces. Use adequate ventilation to avoid breathing vapors, fumes and sanding dust, particularly when working in confined spaces, such as boat interiors. When ventilation cannot be made adequate enough to keep exposures below safe levels, use a NIOSH approved respirator with an organic vapor cartridge, organic vapor cartridge + P100 particulate filter or multi-contaminant cartridge. Consult with your respiratory and cartridge supplier to ensure the proper selection based on chemical ingredients and specific workplace conditions.

Provide ventilation and wear a dust mask when sanding epoxy, especially uncured epoxy. Breathing dust from epoxy that is not fully cured increases your risk of

sensitization. Although epoxy cures quickly to a sandable solid, it may take over two weeks at room temperature, or post-curing, to cure completely.

4. Avoid ingestion. Wash thoroughly after handling epoxy, especially before eating or smoking. If epoxy is swallowed, rinse mouth with water—DO NOT induce vomiting. Because hardeners are corrosive, they can cause additional harm if vomited. Call a physician immediately. Refer to First Aid procedures on the Safety Data Sheet.
5. **KEEP RESINS, HARDENERS, FILLERS AND SOLVENTS OUT OF THE REACH OF CHILDREN.** For additional safety information or data, refer to the Safety Data Sheets or write to: EPOXY SAFETY, WEST SYSTEM, P.O. Box 908, Bay City, MI 48707 USA

16.1.1 Cleanup

Contain large spills with sand, clay or other inert absorbent material. Use a squeegee to contain small spills and collect as much material as possible. Follow up with absorbent towels. Uncontaminated resin or hardener may be reclaimed for use. DO NOT use saw dust or other cellulose materials to absorb hardeners. DO NOT dispose of hardener in trash containing sawdust or other cellulose materials—spontaneous combustion can occur.

Clean resin or mixed epoxy residue with lacquer thinner, acetone or alcohol. Follow all safety warnings on solvent containers. Clean hardener residue with warm soapy water. Clean 207 Hardener residue with lacquer thinner, acetone or alcohol.

Dispose of resin, hardener and empty containers safely. Puncture a corner of the can and drain residue into the appropriate new container of resin or hardener. DO NOT dispose of resin or hardener in a liquid state. Waste resin and hardener can be mixed and cured (in small quantities) to a non-hazardous inert solid.

CAUTION! Large pots of curing epoxy can get hot enough to ignite surrounding combustible materials and give off hazardous fumes. Place pots of mixed epoxy in a safe and ventilated area, away from workers and combustible materials. Dispose of the solid mass only if curing is complete and the mass has cooled. Follow federal, state or local disposal regulations.

16.2 Epoxy products

This section provides a short description of WEST SYSTEM resin, hardeners and fillers. Refer to the current *User Manual & Product Guide* for complete information on all WEST SYSTEM products.

16.2.1 105 Resin and hardeners

Resin

105 Epoxy Resin[®]—A clear, low-viscosity, epoxy resin that can be cured in a wide temperature range to yield a high-strength, rigid solid that has excellent cohesive properties and is an outstanding bonding adhesive and moisture vapor barrier. Two types of WEST SYSTEM hardeners are formulated for use with 105 Resin. 205 and 206 Hardeners require a 5 part resin-to-1 part hardener mixing ratio. 207 and 209 Hardeners require a 3-to-1 mixing ratio.

Hardeners

205 Fast Hardener[®]—Used for general bonding, barrier coating and fabric application. Formulated to cure at lower temperatures and to produce a rapid cure that develops its physical properties quickly at room temperature. 5:1 mix ratio.

206 Slow Hardener[®]—Used for general bonding, barrier coating and fabric application. Formulated for a longer working and cure time or to provide adequate working time at higher temperatures. 5:1 mix ratio.

Note: 205 Fast and 206 Slow Hardener may be blended for intermediate cure times. Always maintain the proper 5 part resin to 1 part hardener ratio. Do not mix 205 or 206 (5-to-1 ratio) Hardeners with 207 or 209 (3-to-1 ratio) Hardeners.

209 Extra Slow Hardener™—Used for general bonding, barrier coating and fabric application in extremely warm and/or humid conditions. Provides approximately twice the pot life and working time as 206 Slow Hardener and adequate pot life up to 110°F (43°C). Also used at room temperatures when a long pot life and working time are required. 3:1 mix ratio.

HARDENER	USES Resin/Hardener	HARDENER TEMPERATURE RANGE (°F)						CURE SPEEDS at room temp.*		
		Room Temp.						POT LIFE 100g cupful	WORKING TIME thin film	CURE TO SOLID thin film
		40°	50°	60°	70°	80°	90°			
205	Fast cure—General bonding, fabric application and barrier coating	[Shaded area]						9–12 minutes	60–70 minutes	6–8 hours
206	Slow cure—General bonding, fabric application and barrier coating	[Shaded area]						20–25 minutes	90–110 minutes	10–15 hours
209	Extra Slow cure—General bonding, fabric application, barrier coating	[Shaded area]						40–50 minutes	3–4 hours	20–24 hours
207	Clear fabric application and clear coating for a natural wood finish	[Shaded area]						20–26 minutes	100–120 minutes	10–15 hours

*Epoxy cures faster in warmer temperatures and in thicker applications—Epoxy cures slower in cooler temperatures and in thinner applications.

Figure 16-1 Select a hardener for its intended use and for the cure speed best suited for your job, in the temperature range you are working in.

207 Special Clear Hardener™—Formulated specifically for barrier coating and fabric application where clear finish is desired. Blush free 207 contains a UV stabilization additive, but still requires long term UV protection with paint or varnish. It provides good physical properties for bonding, but it is less cost effective for this purpose than 205 or 206 hardener. 207 cures clear for a natural wood or clear carbon fiber finish. 3:1 mix ratio.

16.2.2 Specialty Epoxies

G/flex® Epoxies—G/flex Epoxy is a toughened, resilient two-part epoxy engineered to absorb the stresses of expansion, contraction, shock and vibration. It has excellent adhesion to metals, plastics, glass, fiberglass, and wet and difficult-to-bond woods. G/flex is more suitable than 105 Resin-based epoxy for bonding thicker, less dimensionally stable framing members. A 1:1 mix ratio gives you 46 minute pot life and a working time of 75 minutes at 72°F (22°C). It reaches an initial cure in 3–4 hours and a workable cure in 7–10 hours. G/flex is Available in two consistencies. 650 Epoxy is a versatile easily-modified liquid epoxy. 655 Epoxy Adhesive is a convenient pre-thickened epoxy.

Six10® Epoxy Adhesive—Six10 is a two-part thickened epoxy adhesive in a convenient, self-metering cartridge, designed for permanent, waterproof, structural gap-filling and gluing. Six10 Bonds to wood, fiberglass, metals and masonry. With the included 600 Static Mixer attached, fully mixed, non-sagging adhesive can be dispensed in a continuous bead or into tight spaces using a standard caulking gun. Working time is 42 minutes at 72°F (22°C). It cures to a solid in 5–6 hours and takes high loads in 24 hours.

16.2.3 Fillers

Throughout this manual, we will refer to epoxy or resin/hardener mixture, meaning mixed resin and hardener without fillers added; and thickened mixture or thickened epoxy, meaning resin/hardener with one of six fillers added.

Fillers are used to thicken the epoxy for specific applications. They are categorized as either Adhesive Fillers—used for structural bonding or gluing, and gap-filling; or Fairing Fillers—used for cosmetic surface filling. Although each filler has unique handling and cured characteristics that make it more suitable for some jobs than others (Figure 16-2), for most bonding applications any of the adhesive fillers can be used. And for most surface filling, either of the fairing fillers can be used. Fillers may also be blended for intermediate characteristics.

Adhesive fillers

403 Microfibers—For general bonding and gap filling. Epoxy/403 mixtures have superior gap-filling qualities and good strength for most bonding applications while retaining wetting/penetrating capabilities. Works especially well with porous woods. Cures to an off-white color.

404 High-Density Filler—For hardware fastener bonding and applications that require maximum physical properties and where high-cyclic loads are anticipated. Also used for gap-filling where maximum strength is necessary. Cures to an off-white color.

405 Filleting Blend—For use in bonding and filleting on naturally finished wood projects. A strong, wood-toned filler that mixes easily and spreads smoothly. Cures to a brown color and can be used to tint other fillers.

406 Colloidal Silica—For general bonding, gap-filling, high-strength bonds and fillets. A practical and versatile, smooth-textured filler. Can be used alone or mixed with other fillers to improve workability and smoothness. Cures to an off-white color.

Fairing fillers

407 Low-Density Filler—A blended microballoon-based filler used to make a fairing compound that is easy to sand or carve while still being reasonably strong on a strength-to-weight basis. Cures to a reddish-brown color.

410 Microlight™—A very low-density filler for creating a light, easily-worked fairing compound. 410 spreads smoothly and sands very easily when cured. Not recommended under dark colored paint or on other surfaces subject to high temperatures. Cures to a light tan color.

See Appendix B for additional filler selection information.

Filler Selection Guide

Uses—Use description—desired characteristics (Resin/Hardener mixture thickened with a Filler)	ADHESIVE FILLERS				FAIRING FILLERS	
	Highest Density Highest Strength				Lowest Density Easiest Sanding	
	404 High-Density	406 Colloidal Silica	403 Microfibers	405 Filleting Blend	407 Low-Density	410 Microlight®
Bonding Hardware —Increased fastener interface and hardware load capability—maximum strength	★★★★	★★★	★★★	★★		
General Bonding —Join parts with epoxy thickened to create a structural gap filler—strength/gap filling	★★★	★★★	★★★	★★	★	
Bonding with Fillets —Increase joint bonding area and create a structural brace between parts—smoothness/strength	★★	★★★★	★★	★★★	★★★	
Laminating —Bond layers of wood strips, veneers, planks, sheets and cores—gap filling/strength	★★	★★★	★★★★	★★	★★	
Fairing —Fill low areas and voids with an easily sanded surface filler/fairing compound—sandability/gap filling					★★★	★★★★

Filler suitability for various uses: ★★★★★=excellent, ★★★=very good, ★★=good, ★=fair, (no stars)=not recommended.

Figure 16-2 Suitability of WEST SYSTEM fillers for various applications. As a rule, use higher strength fillers when bonding higher density materials, such as hardwoods or metal. Any adhesive filler is suitable for most bonding situations. Your choice of a filler for general use may be based on the handling properties you prefer. Fillers may also be blended to provide intermediate properties.

16.3 Handling epoxy

This section explains the fundamentals of epoxy curing and the steps for proper dispensing, mixing, and adding fillers to assure that every batch of epoxy cures to a useful high-strength solid.

16.3.1 Understanding epoxy's cure stages

Mixing epoxy resin and hardener begins a chemical reaction that transforms the combined liquid ingredients to a solid. The time it takes for this transformation is the

cure time. As it cures the epoxy passes from the liquid state, through a gel state, before it reaches a solid state (Figure 16-3).

1. Liquid—Open time

Open time (also working time or wet lay-up time) is the portion of the cure time, after mixing, that the resin/hardener mixture remains a liquid and is workable and suitable for application. All assembly and clamping should take place during the open time to assure a dependable bond.

2. Gel—Initial cure phase

The mixture passes into an initial cure phase (also called the green stage) when it begins to gel, or “kick off”. The epoxy is no longer workable and will progress from a tacky, gel consistency to the firmness of hard rubber. You will be able to dent it with your thumb nail.

The mixture will become tack free about midway through the initial cure phase. While it is still tacky, a new application of epoxy will still chemically link with it, so the surface may still be bonded to or re-coated without special preparation. However, this ability diminishes as the mixture approaches the final cure phase.

3. Solid—Final cure phase

The epoxy mixture has cured to a solid state and can be dry sanded and shaped. You should not be able to dent it with your thumbnail. At this point the epoxy has reached about 90% of its ultimate strength, so clamps can be removed. It will continue to cure over the next several days at room temperature.

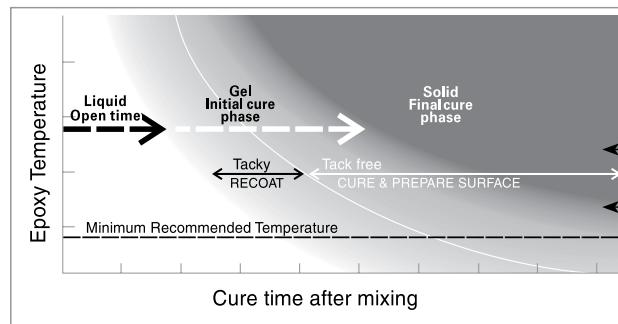

Figure 16-3 As it cures, mixed epoxy passes from a liquid state, through a gel state, to a solid state.

Cure time is *shorter* when the epoxy is warmer.

Cure time is *longer* when the epoxy is cooler.

A new application of epoxy will no longer chemically link to it, so the surface of the epoxy must be properly prepared and sanded before re-coating to achieve a good mechanical, secondary bond. See Section 16.4.1—*Surface Preparation*.

16.3.2 Understanding and controlling cure time

Open time and cure time govern much of the activity of building and repairing with epoxy. Open time dictates the time available for mixing, application, smoothing, shaping, assembly and clamping. Cure time dictates how long you must wait before removing clamps, or before you can sand or go on to the next step in the project. Two factors determine an epoxy mixture’s open time and overall cure time—hardener cure speed and epoxy temperature.

Hardener speed

Each hardener has an ideal temperature cure range (Figure 16-1). At any given temperature, each resin/hardener combination will go through the same cure stages, but at different rates. Select the hardener that gives you adequate working time for the job you are doing at the temperature and conditions you are working under. The product guide and container labels describe hardener pot lives and cure times.

Pot life is a term used to compare the cure speeds of different hardeners. It is the amount of time a specific mass of mixed resin and hardener remains a liquid at a specific temperature—a 100g-mass mixture in a standard container at 72°F (22°C). Because pot life is a measure of the cure speed of a specific contained mass (volume) of epoxy rather than a thin film, a hardener’s pot life is much shorter than its open time.

Epoxy temperature

The warmer the temperature of curing epoxy, the faster it cures (Figure 16-3). Curing epoxy's temperature is determined by the ambient temperature plus the exothermic heat generated by its cure.

Ambient temperature is the temperature of the air or material in contact with the epoxy. Air temperature is most often the ambient temperature unless the epoxy is applied to a surface with a different temperature. Generally, epoxy cures faster when the air temperature is warmer.

Exothermic heat is produced by the chemical reaction that cures epoxy. The amount of heat produced depends on the thickness or exposed surface area of mixed epoxy. In a thicker mass, more heat is retained, causing a faster reaction and more heat. The mixing container shape and mixed quantity have a great affect on this exothermic reaction. A contained mass of curing epoxy (8 fl oz or more) in a plastic mixing cup can quickly generate enough heat to melt the cup and burn your skin. However, if the same quantity is spread into a thin layer, exothermic heat is dissipated, and the epoxy's cure time is determined by the ambient temperature. The thinner the layer of curing epoxy, the less it is affected by exothermic heat, and the slower it cures.

Controlling cure time

In warm conditions use a slower hardener, if possible. Mix smaller batches that can be used up quickly, or quickly pour the epoxy mixture into a container with greater surface area (a roller pan, for example), thereby allowing exothermic heat to dissipate and extending open time. The sooner the mixture is transferred or applied (after thorough mixing), the more of the mixture's useful open time will be available for coating, lay-up or assembly.

In cool conditions use a faster hardener or use supplemental heat to raise the epoxy temperature above the hardeners minimum recommended application temperature. Use a hot air gun, heat lamp or other heat source to warm the resin and hardener before mixing or after the epoxy is applied. At room temperature, supplemental heat is useful when a quicker cure is desired.

CAUTION! Heating epoxy that has not gelled will lower its viscosity, allowing the epoxy to run or sag more easily on vertical surfaces. In addition, heating epoxy applied to a porous substrate (soft wood or low density core material) may cause the substrate to "out-gas" and form bubbles in the epoxy coating. To avoid outgassing, wait until the epoxy coating has gelled before warming it. Never heat mixed epoxy in a liquid state over 120°F (49°C).

Regardless of what steps are taken to control the cure time, thorough planning of the application and assembly will allow you to make maximum use of the epoxy mixture's open time and cure time.

16.3.3 Dispensing and mixing

Careful measuring of epoxy resin and hardener and thorough mixing are essential for a proper cure. Whether the resin/hardener mixture is applied as a coating or modified with fillers or additives, observing the following procedures will assure a controlled and thorough chemical transition to a high-strength epoxy solid.

Dispense the proper proportions of resin and hardener into a clean plastic, metal or wax-free paper container. Don't use glass or foam containers because of the potential danger from exothermic heat build-up. DO NOT attempt to alter the cure time by altering the ratio. An accurate ratio is essential for a proper cure and full development of physical properties.

Dispensing with Mini pumps

Most problems related to curing of the epoxy can be traced to the wrong ratio of resin and hardener. To simplify metering, we recommend using WEST SYSTEM Mini Pumps to dispense the resin and hardener. Mini Pumps mount onto the resin and hardener containers and are calibrated to deliver the proper working ratio of resin to hardener.

Pump one full pump stroke of resin for each one full pump stroke of hardener.

Depress each pump head fully and allow the head to come completely back to the top before beginning the next stroke (Figure 16-4). Partial strokes will give the wrong ratio. Read the pump instructions before using pumps.

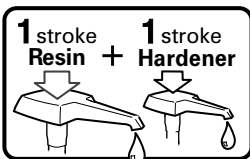

Before you use the first mixture on a project, verify the proper ratio according to the instructions that come with the pumps. Recheck the ratio anytime you experience problems with curing.

Dispensing without Mini Pumps—Weight/volume measure

To measure 105 Resin and 205 or 206 Hardener by weight or volume, combine 5 parts resin with 1 part hardener. To measure 105 Resin and 207 or 209 Hardener by volume, combine 3 parts resin with 1 part hardener. Measuring by weight, 209 Hardener is 3.5 parts resin to 1 part hardener and 207 Hardener is 3.7 parts resin to 1 part hardener.

First time users—If this is the first time you have used WEST SYSTEM Epoxy, begin with a small test batch to get the feel for the mixing and curing process before applying the mixture to your project. This will demonstrate the hardener's open time for the temperature you are working in and assure you that the resin/hardener ratio is metered properly. Mix small batches until you are confident of the mixture's handling characteristics.

Mixing

Stir the two ingredients together thoroughly, at least one minute—longer in cooler temperatures (Figure 16-5). To assure thorough mixing, scrape the sides and bottom of the pot as you mix. Use the flat end of the mixing stick to reach the inside corner of the pot. If you are using a power mixer, occasionally scrape the sides and corners of the mixing pot while mixing. If you are going to be using the mixture for coating, quickly pour it into a roller pan to extend the open time.

WARNING! *Curing epoxy generates heat. Do not fill or cast layers of epoxy thicker than 1/2" (12 mm)—thinner if enclosed by foam or other insulated material. Several inches of mixed epoxy in a plastic mixing cup will generate enough heat to melt the cup if left to stand for its full pot life. For this reason do not use foam or glass mixing containers. If a pot of mixed epoxy begins to exotherm (heat up), quickly move it outdoors. Avoid breathing the fumes. Do not dispose of the mixture until the reaction is complete and has cooled.*

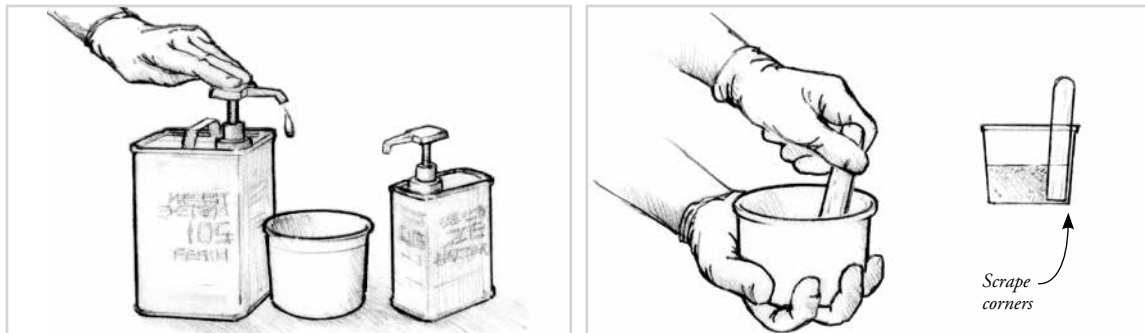

Figure 16-4 Dispense the proper proportions of resin and hardener. **Figure 16-5** Stir resin and hardener together thoroughly, at least one minute—longer in cooler temperatures.

16.3.4 Adding fillers and additives





Fillers

After selecting an appropriate filler for your job (Section 16.2.3), use it to thicken the epoxy mixture to the desired consistency. The thickness of a mixture required for a particular job is controlled by the amount of filler added. There is no strict formula or measuring involved—use your eye to judge what consistency will work best. Figure 16-6 gives you a general guide to the differences between unthickened epoxy and the three consistencies referred to in this manual.

Always add fillers in a two-step process:

1. Mix the desired quantity of resin and hardener thoroughly before adding fillers. Begin with a small batch—allow room for the filler.

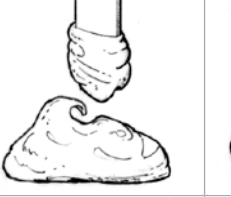
Figure 16-6 Epoxy can be thickened to the exact consistency needed for a particular job. The procedures in this manual refer to four common consistencies; syrup, catsup, mayonnaise and peanut butter.

CONSISTENCY	Unthickened (neat)	Slightly Thickened	Moderately Thickened	Maximum Thickness
	Syrup	Catsup	Mayonnaise	Peanut Butter
GENERAL APPEARANCE				
CHARACTERISTICS	Drips off vertical surfaces.	Sags down vertical surfaces.	Clings to vertical surfaces, peaks fall over.	Clings to vertical surfaces, peaks stand up.
USES	Coating, "wetting-out" before bonding, applying fiberglass, graphite and other fabrics.	Laminating/bonding flat panels with large surface areas, injecting with a syringe.	General bonding, filleting, hardware bonding.	Gap filling, filleting, fairing, bonding uneven surfaces.

2. Blend in small handfuls or scoops of the appropriate filler until the desired consistency is reached (Figure 16-7).

For maximum strength, add only enough filler to completely bridge gaps between surfaces without sagging or running out of the joint or gap. A small amount should squeeze out of joints when clamped. For thick mixtures, don't fill the mixing cup more than $\frac{1}{3}$ full of epoxy before adding filler. When making fairing compounds, stir in as much 407 or 410 as you can blend in smoothly—for easy sanding, the thicker the better. Be sure all of the filler is thoroughly blended before the mixture is applied.

Additives

Additives are used to give epoxy additional physical properties when used as a coating. Although additives are blended with mixed epoxy in the same two-step process as fillers, they are not designed to thicken the epoxy. Follow the mixing instructions on the individual additive containers.



Figure 16-7 Blend in small handfuls or scoops of the appropriate filler until the desired consistency is reached.

16.3.5 Removing epoxy

Removing uncured or non-curing epoxy. Removed uncured epoxy as you would spilled resin. Scrape as much material as you can from the surface using a stiff metal or plastic scraper—warm the epoxy to lower its viscosity. Clean the residue with lacquer thinner, acetone, or alcohol. Follow safety warnings on solvents and provide adequate ventilation. After re-coating wood surfaces with epoxy, it's a good idea to brush the wet epoxy (in the direction of the grain) with a wire brush to improve adhesion. Allow solvents to dry before re-coating.

Removing fiberglass cloth applied with epoxy. Use a heat gun to heat and soften the epoxy. Start in a small area near a corner or an edge. Apply heat until you can slip a putty knife or chisel under the cloth—about 200°F (93°C). Grab the edge with a pair of pliers and pull up on the cloth while heating just ahead of the separation. On large areas, use a utility knife to score the glass and remove in narrower strips. Resulting surface texture may be coated or remaining epoxy may be removed as follows.

Removing cured epoxy coating. Use a heat gun to soften the epoxy (200°F). Heat a small area and use a paint or cabinet scraper to remove the bulk of the coating. Sand the surface to remove the remaining material. Provide ventilation when heating epoxy.

16.4 Basic techniques

The following basic techniques are common to most repair or building projects, regardless of the type of structure or material you are working with.

16.4.1 Surface preparation

Whether you are bonding, fairing or applying fabrics, the success of the application depends not only on the strength of the epoxy, but also on how well the epoxy adheres to the surface to which it is being applied. Unless you are bonding to partially cured epoxy, the strength of the bond relies on the epoxy's ability to mechanically "key" into the surface. That is why the following three steps of surface preparation are a critical part of any secondary bonding operation.

For good adhesion, bonding surfaces should be:

1. **Clean**—Bonding surfaces must be free of any contaminants such as grease, oil, wax or mold release. Clean contaminated surfaces with lacquer thinner, acetone or other appropriate solvent. Wipe the surface with paper towels before the solvent dries. Clean surfaces before sanding to avoid sanding the contaminant into the surface. Follow all safety precautions when working with solvents.
2. **Dry**—All bonding surfaces must be as dry as possible for good adhesion. If necessary, accelerate drying by warming the bonding surface with hot air guns, hair dryers or heat lamps. Use fans to move the air in confined or enclosed spaces. Watch for condensation when working outdoors or whenever the temperature of the work environment changes.
3. **Sanded**—Sand smooth non-porous surfaces—thoroughly abrade the surface. For most surfaces, 80-grit aluminum oxide paper will provide a good texture for the epoxy to "key" into. Be sure the surface to be bonded is solid. Remove any flaking, chalking, blistering, or old coating before sanding. Remove all dust after sanding.



Special preparation for various materials

Cured epoxy—Amine blush can appear as a wax-like film on cured epoxy surfaces. It is a byproduct of the curing process and may be more noticeable in cool, moist conditions. Amine blush can clog sandpaper and inhibit subsequent bonding, but it can easily be removed. It's a good idea to assume it has formed on any cured epoxy surface.

To remove the blush, wash the surface with clean water only (not solvent) and an abrasive pad, such as Scotch-brite™ 7447 General Purpose Hand Pads. Dry the surface with paper towels to remove the dissolved blush before it dries on the surface. Sand any remaining glossy areas with 80-grit sandpaper. Wet-sanding will also remove the amine blush. If a release fabric is applied over the surface of fresh epoxy, all amine blush will be removed when the release fabric is peeled from the cured epoxy and no additional sanding is required.

Epoxy surfaces that have not fully cured may be bonded to or coated with epoxy without washing or sanding. Before applying coatings other than epoxy (paints, bottom paints, varnishes, gelcoats, etc.), allow epoxy surfaces to cure fully, then wash and sand.

Hardwoods—Sand with 80-grit paper

Teak/oily woods—Wipe with acetone 15 minutes before coating. The solvent dries the oil at the surface and allows epoxy to penetrate. Be sure the solvent has evaporated before coating.

Porous woods—No special preparation needed. If surface is burnished, possibly by dull planer blades, sand with 80-grit paper to open pores.

Steel, lead—Remove contamination, sand or grind to bright metal, coat with epoxy then sand fresh epoxy into surface. Re-coat or bond after first coat gels.

Aluminum—Sand with 80-grit sandpaper and apply epoxy within an hour.

Polyester (fiberglass)—Clean contamination with a silicone and wax remover such as DuPont Prep-Sol™ 3919S. Sand with 80-grit paper to a dull finish.

Plastic—G/flex epoxy provides the best adhesion to plastics but adhesion varies. If a plastic is impervious to solvents such as acetone, epoxy generally will not bond to it. Soft, flexible plastics such as polyethylene, polypropylene, nylon, Plexiglas and polycarbonate fall into this category.

Hard, rigid plastics such as PVC, ABS and styrene provide better adhesion with good surface preparation and adequate bonding area. After sanding, flame oxidizing (by quickly passing propane torch over the surface without melting the plastic) can improve bonding in some plastics including polyethylene. It's a good idea to conduct an adhesion test on a plastic that you are uncertain about.

16.4.2 Bonding (gluing)

This section refers to two types of bonding. Two-step bonding is the preferred method for most situations because it promotes maximum epoxy penetration into the bonding surface and prevents resin-starved joints. Single-step bonding can be used when joints have minimal loads and excess absorption into porous surfaces is not a problem.

Before mixing epoxy, check all parts to be bonded for proper fit and surface preparation (Section 16.4.1—*Surface preparation*), gather all the clamps and tools necessary for the operation, and cover any areas that need protection from spills.

Two-step bonding

1. Wet-out bonding surfaces—Apply a straight resin/hardener mixture (without fillers) to the surfaces to be joined (Figure 16-8). Wet out small or tight areas with a disposable brush. Wet out larger areas with a foam roller or by spreading the resin/hardener mixture evenly over the surface with a plastic spreader. You may proceed with step two immediately or any time before the wet-out coat becomes completely tack free.
2. Apply thickened epoxy to one bonding surface. Modify the resin/hardener mixture by stirring in the appropriate filler until it becomes thick enough to bridge any gaps



Figure 16-8 Wet out bonding surfaces with unthickened epoxy for maximum penetration and greater adhesion.



Figure 16-9 Apply enough thickened epoxy to one of the bonding surfaces so that a small amount will squeeze out of the joint when clamped with moderate pressure.

between the mating surfaces and to prevent “resin-starved” joints. Apply enough of the mixture to one of the surfaces so that a small amount will squeeze out when the surfaces are joined together with a force equivalent to a firm hand grip (Figure 16-9). Six10 Epoxy Adhesive may also be used.

Thickened epoxy can be applied immediately over the wet-out surface or any time before the wet-out becomes completely tack free. For most small bonding operations, add the filler to the resin/hardener mixture remaining in the batch that was used for the wet-out. Mix enough resin/hardener for both steps. Add the filler quickly after the surface is wet out and allow for a shorter working life of the mixture.

3. Clamp components. Attach clamps as necessary to hold the components in place. Use just enough clamping pressure to squeeze a small amount of the epoxy mixture from the joint, indicating that the epoxy is making good contact with both mating surfaces (Figure 16-10). Avoid using too much clamping pressure, which can squeeze all of the epoxy mixture out of the joint.
4. Remove or shape excess adhesive that squeezes out of the joint as soon as the joint is secured with clamps. A wooden mixing stick with one end sanded to a chisel edge is an ideal tool for removing the excess (Figure 16-11).

Single-step bonding

Single-step bonding is applying the thickened epoxy directly to the component without first wetting out with resin/hardener only. Six10 Epoxy Adhesive and G/flex 655 Epoxy are thickened epoxies that are ideal for single-step bonding because they are formulated to wet out surfaces. When using 105 Resin-based epoxy we recommend that you thicken the epoxy no more than is necessary to bridge gaps in the joint. Keep in mind that thinner mixtures are more able to penetrate the surface, but less able to bridge gaps. Conversely, thicker mixtures are more able to bridge gaps but less able to penetrate surfaces. We do not recommend this single-step method using thickened 105 Resin epoxies for highly-loaded joints or for bonding end grain or other porous surfaces.

Laminating

The term “laminating” refers to the process of bonding numbers of relatively thin sheets, like plywood, veneers, fabrics or core material to create a composite. A composite may be any number of layers of the same material or combinations of different materials. Methods of epoxy application and clamping will differ depending on what you are laminating.

Because of large surface areas and limitations of wet lay-up time, roller application is the most common method for applying epoxy. A faster method for large surfaces is to simply pour the resin/hardener mixture onto the middle of the panel and spread the mixture evenly over the surface with a plastic spreader. Apply thickened mixtures with an 809 Notched Spreader.

Using staples or screws is the most common method of clamping when you laminate a solid material to a solid substrate. An even distribution of weights will work when you are laminating a solid material to a base that will not hold staples or screws, such as a foam or honeycomb core material.

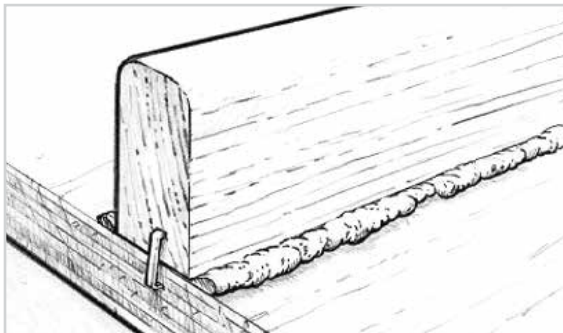

Figure 16-10 A small amount of epoxy will squeeze out of the joint with just the right amount of thickened mixture and clamping pressure.

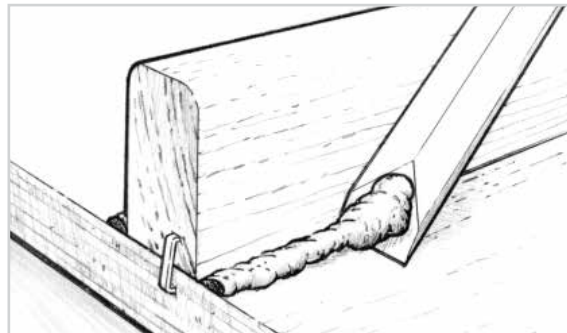

Figure 16-11 Remove excess epoxy before it begins to gel. A sharpened mixing stick makes an excellent cleanup tool.

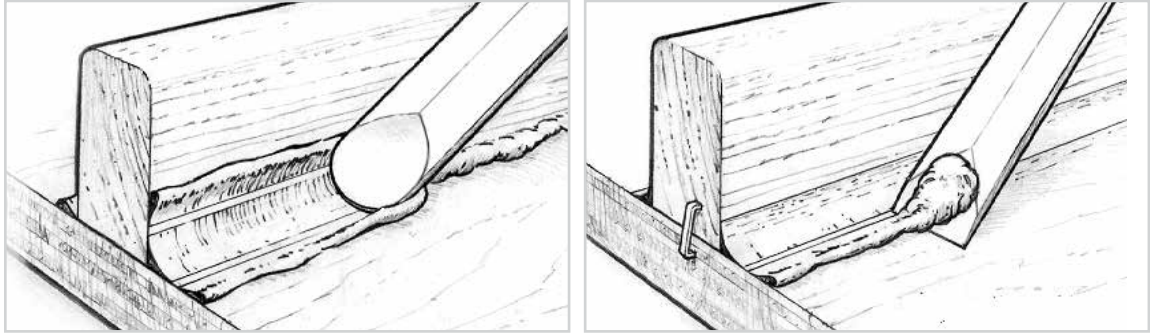

Figure 16-12 Shape and smooth the fillet with a rounded tool.

Figure 16-13 Clean up remaining excess epoxy outside of the clean margin before it cures.

Vacuum bagging is the ideal clamping method for laminating a wide range of materials. Through the use of a vacuum pump and plastic sheeting, the atmosphere is used to apply perfectly even clamping pressure over all areas of a panel regardless of the size, shape or number of layers.

Clamping

Any method of clamping is suitable as long as the parts to be joined are held so that movement will not occur. Methods of clamping include spring clamps, “C” clamps and adjustable bar clamps, heavy rubber bands cut from inner tubes, nylon-reinforced packaging tape, applying weights, and vacuum bagging. When placing clamps near epoxy-covered areas, use polyethylene sheeting or peel ply under the clamps so they don’t inadvertently bond to the surface. Staples, nails or drywall screws are often used where conventional clamps will not work. Any fasteners that need to be left in should be of a non-corroding alloy such as bronze. In some cases the thickened epoxy or gravity will hold parts in position without clamps.

16.4.3 Bonding with fillets

A fillet (fil’it) is a cove-shaped application of thickened epoxy that bridges an inside corner joint. It is excellent for bonding parts because it increases the surface area of the bond and serves as a structural brace. All joints that will be covered with fiberglass cloth will require a fillet to support the cloth at the inside corner of the joint.

The procedure for bonding with fillets is the same as normal bonding, except that instead of removing the squeezed-out thickened epoxy after the components are clamped in position, you shape it into a fillet. For larger fillets, add thickened mixture to the joint as soon as the bonding operation is complete, before the bonding mixture is fully cured, or any time after the final cure and sanding of exposed epoxy in the fillet area.

1. Bond parts as described in Section 16.4.2.
2. Shape and smooth the squeezed-out thick epoxy into a fillet by drawing a rounded filleting tool (mixing stick) along the joint, dragging excess material ahead of the tool and leaving a smooth cove-shaped fillet bordered on each side by a clean margin. Some excess filleting material will remain outside of the margin (Figure 16-12). Use the excess material to refill any voids. Smooth the fillet until you are satisfied with its appearance. A mixing stick will leave a fillet with about a $\frac{3}{8}$ " (9 mm) radius. For larger fillets, an 808 Plastic Squeegee, cut to shape or bent to the desired radius, works well.

Apply additional thickened epoxy to fill voids or make larger fillets. Apply the mixture along the joint line with the rounded mixing stick, using enough mixture to create the desired size of fillet. For longer or multiple fillets, empty caulking gun cartridges or disposable cake decorating bags can be used. Cut the plastic tip to lay a bead of thickened epoxy large enough for the desired fillet size. Heavy duty, sealable food storage bags with one corner cut off may also be used.

3. Clean up the remaining excess material outside of the margin by using a sharpened mixing stick or a putty knife (Figure 16-13). Fiberglass cloth or tape may be applied over the fillet area before the fillet has cured (or after the fillet is cured and sanded).

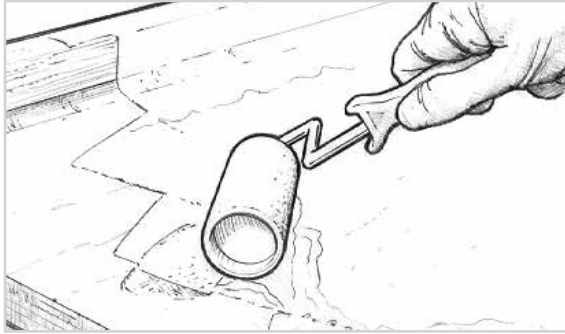

Figure 16-14 Wet out porous surfaces before applying thickened fairing compound.

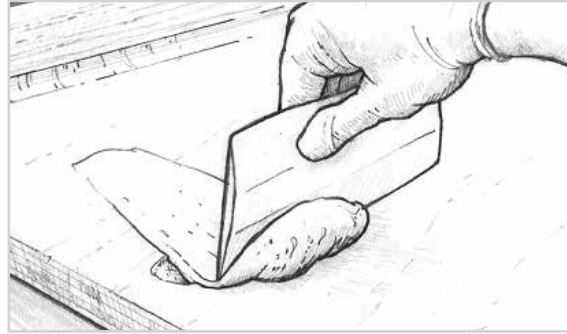

Figure 16-15 Trowel the thickened epoxy fairing compound into the voids and depressions with a plastic spreader.

4. Sand smooth with 80-grit sandpaper after the fillet has fully cured. Wipe the surface clean of any dust and apply several coats of resin/hardener over the entire fillet area before final finishing.

16.4.4 Fairing

Fairing refers to the filling and shaping of low areas so they blend with the surrounding surfaces and appear “fair” to the eye and touch. After major structural assembly has been completed, final fairing can be easily accomplished with WEST SYSTEM Epoxy and low-density fillers.

1. Prepare the surface as you would for bonding (Section 16.4.1). Sand smooth any bumps or ridges on the surface and remove all dust from the area to be faired.
2. Wet out porous surfaces with unthickened epoxy (Figure 16-14).
3. Mix resin/hardener and thicken with 407 Low-Density or 410 Microlight® filler to a peanut butter consistency.
4. Trowel on the thickened epoxy mixture with a plastic spreader, working it into all voids and depressions. Smooth the mixture to the desired shape, leaving the mixture slightly higher than the surrounding area (Figure 16-15). Remove any excess thickened epoxy before it cures. If the voids you are filling are over ½" deep, apply the mixture in several applications or use 206 Slow Hardener or 209 Extra Slow Hardener, depending on ambient temperature.
5. Allow the final thickened epoxy application to cure thoroughly.
6. Sand the fairing material to blend with the surrounding contour (Figure 16-16). Begin with 50-grit sandpaper if you have a lot of fairing material to remove. Use 80-grit paper on the appropriate sanding block when you are close to the final contour.

CAUTION! Don't forget your dust mask. Remove the sanding dust and fill any remaining voids following the same procedure.

7. Apply several coats of resin/hardener to the area with a disposable brush or roller after you are satisfied with the fairness. Allow the final coat to cure thoroughly before final sanding and finishing.



Figure 16-16 Sand the fairing material to blend with the surrounding contour.

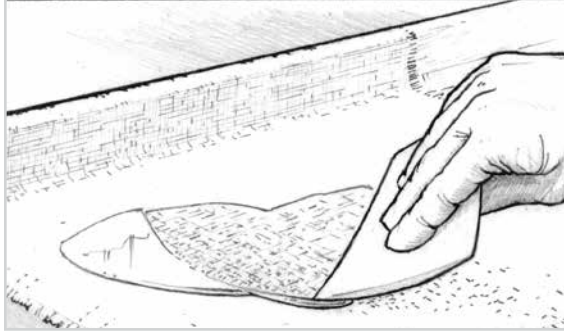

Figure 16-17 Spread the epoxy from the center of the fabric toward the edges with a plastic spreader.

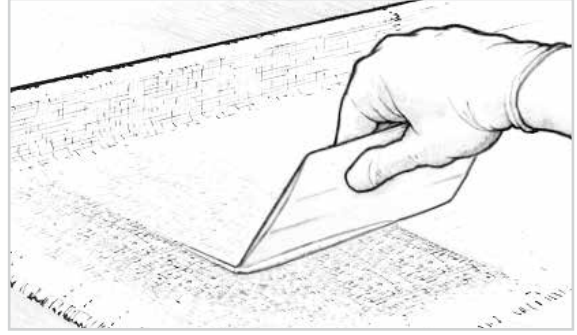

Figure 16-18 Squeegee away excess epoxy before the first batch begins to gel.

16.4.5 Applying woven cloth and tape

Fiberglass cloth is applied to surfaces to provide reinforcement and/or abrasion resistance, or in the case of Douglas Fir plywood, to prevent grain checking. It is usually applied after fairing and shaping are completed, and before the final coating operation. It is also applied in multiple layers (laminated) and in combination with other materials to build composite parts. Fiberglass cloth may be applied to surfaces by either of two methods. The “dry” method refers to applying the cloth over a dry surface. The “wet” method refers to applying the cloth to an epoxy-coated surface often after the wet-out coat becomes tacky, which helps it cling to vertical or overhead surfaces. Since this method makes it more difficult to position the cloth, the dry method is the preferred method especially with thinner cloth.

Dry method

1. Prepare the surface as you would for bonding (Section 16.4.1).
2. Position the cloth over the surface and cut it several inches larger on all sides. If the surface area you are covering is larger than the cloth size, allow multiple pieces to overlap by approximately two inches. On sloped or vertical surfaces, hold the cloth in place with masking or duct tape, or with staples.
3. Mix a small quantity of epoxy (three or four pumps each of resin and hardener).
4. Pour a small pool of resin/hardener near the center of the cloth.
5. Spread the epoxy over the cloth surface with a plastic spreader, working the epoxy gently from the pool into the dry areas (Figure 16-17). Use a foam roller or brush to wet out fabric on vertical surfaces. Properly wet out fabric is transparent. White areas indicate dry fabric. If you are applying the cloth over a porous surface, be sure to leave enough epoxy to be absorbed by both the cloth and the surface below it. Try to limit the amount of squeegeeing you do. The more you “work” the wet surface, the more minute air bubbles are placed in suspension in the epoxy. This is especially important if you plan to use a clear finish (see below). You may use a roller or brush to apply epoxy to horizontal as well as vertical surfaces.

Smooth wrinkles and position the cloth as you work your way to the edges. Check for dry areas (especially over porous surfaces) and re-wet them as necessary before proceeding to the next step. If you have to cut a pleat or notch in the cloth to lay it flat on a compound curve or corner, make the cut with a pair of sharp scissors and overlap the edges for now.

Note: For clear wood finishes, an alternative wet out method is to lay the epoxy onto the fabric with a short-bristled brush. Dip the brush in the epoxy and lay the epoxy on the surface in a light even stroke. Don't force the epoxy into the cloth, which may trap air in the fabric and show through the clear finish. Apply enough epoxy to saturate the fabric and the wood below. After several minutes, lay on additional epoxy to dry (white) areas.

7. Squeegee away excess epoxy before the first batch begins to gel (Figure 16-18). Drag the spreader over the fabric, using even-pressured, overlapping strokes. Use enough pressure to remove excess epoxy that would allow the cloth to float off the surface, but

not enough pressure to create dry spots. Excess epoxy appears as a shiny area, while a properly wet-out surface appears evenly transparent, with a smooth, cloth texture. Later coats of epoxy will fill the weave of the cloth.

8. Trim the excess and overlapped cloth after the epoxy has begun to gel, using a sharp utility knife (Figure 16-19). Trim overlapped cloth, if desired, as follows:
 - a) Place a metal straightedge on top of and midway between the two overlapped edges.
 - b) Cut through both layers of cloth with a sharp utility knife (Figure 16-20).
 - c) Remove the topmost trimming and then lift the opposite cut edge to remove the overlapped trimming (Figure 16-21).
 - d) Re-wet the underside of the raised edge with epoxy and smooth into place.

The result should be a near perfect butt joint, eliminating double cloth thickness. A lapped joint is stronger than a butt joint, so if appearance is not important, you may want to leave the overlap and fair in the unevenness after coating.

9. Coat the surface to fill the weave before the wet-out becomes completely tack free (Figure 16-22). Follow the procedures for epoxy barrier coating under Section 16.4.6. It will take two or three coats to completely fill the weave of the cloth and to allow for a final sanding that will not affect the cloth.



Figure 16-19 Trim excess cloth after the epoxy has begun to gel using a sharp utility knife.

Wet method

An alternative is to apply the fabric or tape to a surface coated with wet epoxy. As mentioned, this is not the preferred method, especially with large pieces of cloth, because of the difficulty removing wrinkles or adjusting the position of the cloth as it is being wet out. However, you may come across situations when this method may be useful or necessary.

1. Prepare the surface (Section 16.4.1).
2. Pre-fit and trim the cloth to size. Roll the cloth neatly so that it may be conveniently rolled back into position later.
3. Roll a heavy coat of epoxy on the surface.
4. Unroll the glass cloth over the wet epoxy and position it. Surface tension will hold most cloth in position. If you are applying the cloth vertically or overhead, refer to Appendix C for detailed instructions. Work out wrinkles by lifting the edge of the cloth and smoothing from the center with your gloved hand or a spreader.

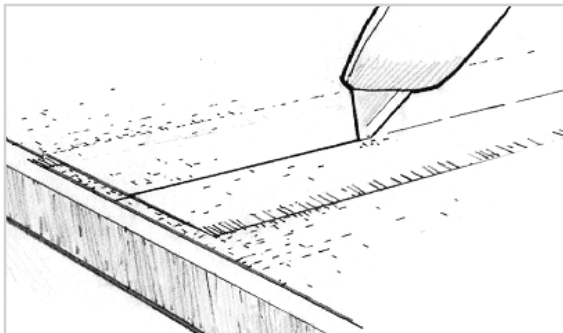

Figure 16-20 Trim overlapping fabric using a metal straightedge and a sharp utility knife, for a flush butt joint.

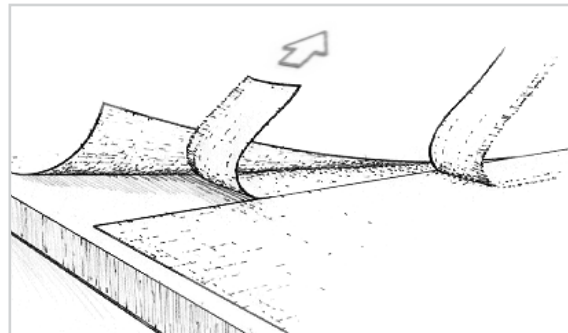

Figure 16-21 Remove the topmost trimming. Then lift the opposite cut edge to remove the overlapped trimming.

5. Apply a second coat of epoxy with a foam roller. Apply enough epoxy to thoroughly wet out the cloth.
6. Remove the excess epoxy with a spreader, using long overlapping strokes. The cloth should appear consistently transparent with a smooth cloth texture.
7. Follow steps 7, 8 and 9 under the dry method to finish the procedure.

Any remaining irregularities or transitions between cloth and substrate can be faired by using an epoxy/filler fairing compound if the surface is to be painted. Any additional fairing done after the final coating should receive several additional coats over the faired area.

16.4.6 Epoxy barrier coating

The object of final coating is to build up an epoxy coating that provides an effective moisture barrier and a smooth base for final finishing.

Apply a minimum of two coats of WEST SYSTEM Epoxy for an effective moisture barrier. Apply three coats if sanding is to be done. Moisture protection will increase with additional coats, up to six coats or about a 20 mil thickness. Additives or pigments should not be added to the first coat. Mixing thinners with WEST SYSTEM Epoxy is not recommended.

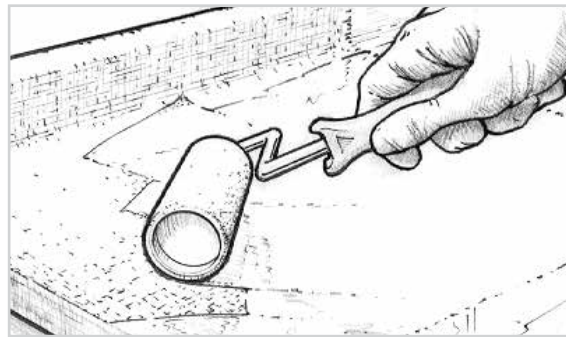

Figure 16-22 Apply the first coat of unthickened epoxy to fill the weave of the cloth before the wet-out coat becomes completely tack free.

Disposable, thin urethane foam rollers, such as WEST SYSTEM 800 Roller Covers, allow you greater control over film thickness, are less likely to cause the epoxy to exotherm and leave less stipple than thicker roller covers. Cut the covers into narrower widths to reach difficult areas or for long narrow surfaces like stringers.

Complete all fairing and cloth application before beginning the final coating. Allow the temperature of porous surfaces to stabilize before coating. Otherwise, as the material warms up, air within the porous material may expand and pass from the material (outgassing) through the coating and leave bubbles in the cured coating.

1. Prepare the surface as necessary (Section 16.4.1).
2. Mix only as much resin/hardener as you can apply during the open time of the mixture. Pour the mixture into a roller pan as soon as it is mixed thoroughly.
3. Load the roller with a moderate amount of the epoxy mixture. Roll the excess out on the ramp part of the roller pan to get a uniform coating on the roller.
4. Roll lightly and randomly over an area approximately 2'x2' (60 cm x60 cm) to transfer the epoxy evenly over the area (Figure 16-23).
5. As the roller dries out, increase pressure enough to spread the epoxy into a thin, even film. Increase the coverage area, if necessary, to spread the film more thinly and evenly. The thinner the film, the easier it is to keep it even and avoid runs or sags in each coat.
6. Finish the area with long, light, even strokes to reduce roller marks. Overlap the previously coated area to blend both areas together.
7. Coat as many of these small working areas as you can with each batch. If a batch begins to thicken before it can be applied, discard it and mix a fresh, smaller batch.
8. Drag a foam roller brush lightly over the fresh epoxy in long, even, overlapping strokes after each full batch is applied. Use enough pressure to smooth the stipple, but not enough to remove any of the coating (Figure 16-24). Alternate the direction in which

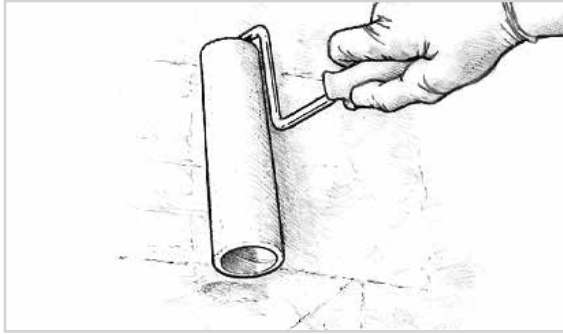

Figure 16-23 Apply the epoxy in thin even coats using a thin foam roller.

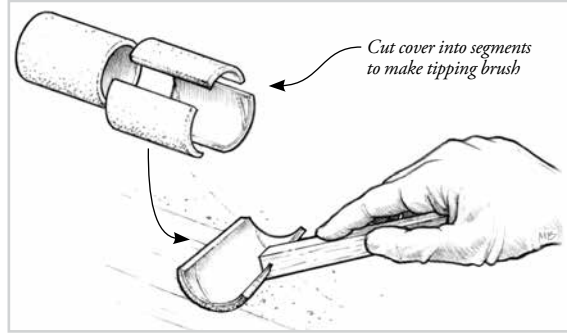

Figure 16-24 Tip off the fresh coat of epoxy with the grain, using a foam roller brush to remove bubbles and roller marks.

each coat is tipped off, 1st coat vertical, 2nd coat horizontal, 3rd coat vertical, etc. A WEST SYSTEM 800 Roller Cover can be cut into segments to make a tipping bush.

Re-coating

Apply second and subsequent coats of epoxy following the same procedures. Make sure the previous coat has cured firmly enough to support the weight of the next coat. To avoid sanding between coats, apply additional coats before the previous coat has become completely tack free and apply all of the coats in the same day. See Special preparation—Cured epoxy in Section 16.4.1. After the final coat has cured overnight, wash and sand it to prepare for the final finish.

16.4.7 Final surface preparation

Proper finishing techniques will not only add beauty to your efforts, but will also protect your work from ultraviolet light which will break down the epoxy over time. The most common methods of finishing are painting or varnishing. These coating systems protect the epoxy from ultraviolet light and require proper preparation of the surface before application.

Preparation for the final finish is just as important as it is for re-coating with epoxy. The surface must first be clean, dry and sanded (Section 16.4.1).

1. Allow the final epoxy coat to cure thoroughly.
2. Wash the surface with a Scotch-brite™ pad and water. Dry with paper towels
3. Sand to a smooth finish. If there are runs or sags, begin sanding with 80-grit paper to remove the highest areas. Sand until the surface feels and looks fair. Complete sanding with the appropriate grit for the type of coating to be applied. Generally, the thinner the coating, the finer the grit. Paint adhesion relies on the mechanical grip of the paint keying into the sanding scratches in the epoxy's surface. If a high-build or filling primer is to be applied, 80–100-grit is usually sufficient. For primers and high-solids coatings, 120–180-grit may be adequate. Finishing with 220–400-grit paper is often recommended for coatings with high-gloss finishes. Grits finer than this may not provide enough tooth for good adhesion. Follow the coating manufacturer's recommendation for surface preparation. Wet sanding is preferred by many people because it reduces sanding dust and it will allow you to skip Step 2. Wet sanding is often used for final sanding after an initial machine sanding with a coarse grit.
4. After you are satisfied with the texture and fairness of the surface, rinse the surface with fresh water. Rinse water should sheet evenly without beading or fish-eyeing. If rinse water beads up (a sign of contamination), wipe the area with solvent and dry with a paper towel, then wet sand again until beading is eliminated.

Proceed with your final coating after the surface has dried thoroughly. To reduce the possibility of contamination, it is a good idea to begin coating within 24 hours of the final sanding. Follow all of the instructions from the coating system's manufacturer. It may be a good idea to make a test panel to evaluate the degree of surface preparation required and the compatibility of the finish system.

Appendix A

Abrasives

Abrasives, specifically the different types of sandpaper, are the primary tool for removing material in fairing and finishing operations. Sandpaper is available in a variety of forms, grits and composition.

The abrasive mineral particles are bonded to a cloth or paper backing, in sheets, discs and belts. 9" x 11" sheets are the most common form. They can be cut or folded to a convenient size for hand sanding or to fit pad sanders. Narrower sheets are sized for machine sanders. 2¾" x 16½" or 17½" adhesive backed sizes are designed for air file sanders, but also work well on fairing boards or blocks. Discs come in a variety of diameters. 5", 6" and 8" are the most common and are available with pressure sensitive adhesive backs. Some manufacturers offer hook and loop type discs and corresponding pads. Plain backed papers can be mounted to blocks or boards with contact adhesive.

Sandpaper can come in "open coat" or "closed coat". Open coat means the mineral particles are spread out more and are less likely to "load up" or clog as easily as closed coat papers. Sandpaper is identified by the abrasive mineral on the face. Each mineral has different qualities of hardness (cutting ability) and toughness (wearing ability). The following types are most often used for fairing and finishing:

Zirconia Alumina—Fairly aggressive cutting action, very long wearing (toughest), useful for rough fairing.

Aluminum Oxide—Aggressive cutting action, long wearing, good all around paper for rough and finish sanding.

Silicon Carbide—Very aggressive cutting action (hardest), moderately long wearing, useful for finishing and wet-sanding (with waterproof paper).

Grit refers to the mineral particle size and generally determines the amount of material a paper will remove and how smooth it will leave the surface. The following grits are useful for fairing and finishing:

36 to 50 grit—Rough fairing depending on the type and amount of material.

50 to 80 grit—Local fairing and preparation for the epoxy barrier coat.

80 to 100 grit—Preparing the epoxy barrier coat if a high-build or filling primer is to be applied.

120 to 180 grit—Preparing the epoxy barrier coat for primers and high-solids coatings.

220 to 400 grit—Preparing the epoxy barrier coat for most paints or varnishes and sanding between coats of paint or varnish. The thinner the coating film thickness, the finer the grit.

Tools

Most fiberglass repair procedures can be completed with a small inventory of common or readily available hand and power tools. The tools listed here are specially suited for repair procedures in this manual or for working with epoxy.

Roller cover brushes

Roller cover brushes are made by cutting WEST SYSTEM 800 Roller covers into segments. They are used to "tip off" coats of epoxy to remove bubbles and roller marks. Drag the brush over fresh epoxy in long, even, overlapping strokes after each batch is applied. Use enough pressure to smooth the surface without removing epoxy.

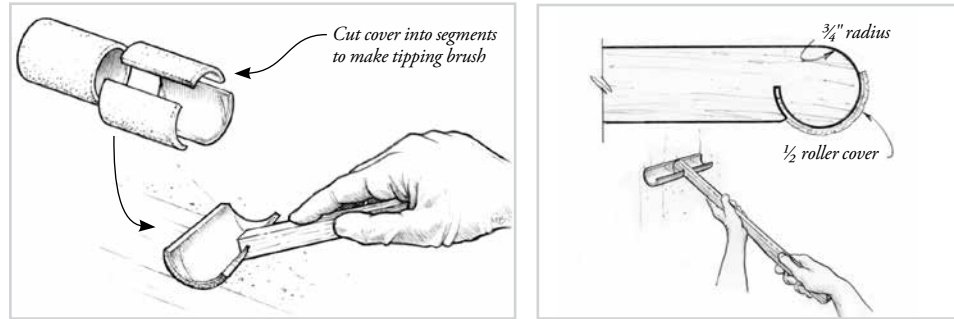

To create a roller brush, cut an 800 roller cover in half to create a 3 1/2" wide roller. Cut one of the halves of roller cover lengthwise into three equal segments and attach a handle.

Cooler box—pot life extender

This insulated box is designed to control the pot life of a roller pan or mixing cup full of epoxy by removing excess heat generated by the epoxy's exothermic reaction. In warm climates the cooler can extend the working life of a batch of epoxy.

All parts are 1" Styrofoam™ building insulation bonded together with epoxy thickened to a "peanut butter" consistency. Any available filler may be used.

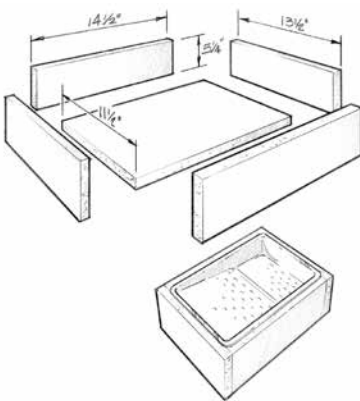

Apply fillets at all inside corners and coat with epoxy to extend the life of the cooler box, after the bonds holding the panels together have cured.

To use in hot weather, fill the box with two or three inches of water (enough to contact the bottom of the pan) and a couple ice cubes. The box is designed to absorb excess heat rather than chill the epoxy and can extend the working life of a batch of epoxy up to 10 times longer than what would be expected at high temperatures. This allows 205 Fast Hardener to be used in temperatures that normally would have required you to use 206 Slow or 209 Extra Slow Hardener.

In cool weather, fill the box with warm water to keep the viscosity of the epoxy thin and easy to apply.

Alter the dimensions as necessary so your particular roller pan fits within the sides of the box and the lip of the pan rests on top of the side panels.

Designed by John Koeck

Grinders

Grinding to remove damaged laminate and preparing an area for bonding is a key step in many of the procedures throughout this manual. The proper grinder can make a big difference in the quality and efficiency of these operations.

We recommend using a 7" polisher (about 2000 RPM), with an 8" diameter, 1/2" thick foam sanding pad attached.

Use 36-50 grit paper, either self adhesive or attached with feathering disc adhesive, for quick removal or general shaping. Use 80 grit for finer shaping and smoothing.

RapidStrip™ Brush

We recommend the Norton® RapidStrip Brush #01123 for cleaning heavily textured areas like the exposed woven roving in the bottom of hulls. Running the 4" RapidStrip Brush in a drill motor in two directions, one 90° from the other will insure that the low spots between fiberglass bundles are thoroughly abraded in preparation for bonding.



Fairing boards

A long flexible sanding block is the primary tool for overall fairing. Working on the same principle as a batten, it will bend to the overall shape of the surface, bridging the low areas and knocking down the high spots. A long fairing block can be made of 1/4" to 1/2" plywood, depending on the curve of the surface to be faired. The length of the block is a multiple of 11" to make economical use of a 9" x 11" sheet of sandpaper. The width of the

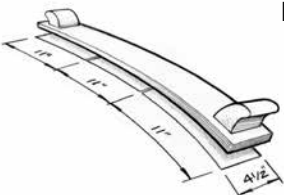

block is $4\frac{1}{2}$ " or half a sheet. The sandpaper is applied to the block with feathering disc adhesive. Handles may be bonded to the ends of the block for greater control.

Making a flexible sanding board

Long, stiff sanding boards work well on gently curving structures. However, where surfaces are more tightly curved, very little of the sanding board will actually touch the surface.

Make a flexible sanding block for these surfaces by gluing $\frac{3}{8}$ "-thick redwood to conveyor belt material. Scuff the belt material up so it will bond with epoxy. After the epoxy cures, make saw cuts parallel to the length of the redwood on $\frac{1}{2}$ " apart. Make the cuts just deep enough to pass through the wood but not into the conveyor belt. These cuts allow the sanding board to conform to concave or convex surfaces across the width of the sanding board while remaining stiff along the length. By varying the thickness of the wood and the distance between saw cuts, you can adjust the stiffness and edgewise flexibility of the tool.

Make a waterproof version for wet sanding by using of two skins of flexible conveyor belting separated by a layer of low-density closed-cell foam core. Glue $\frac{1}{16}$ " thick conveyor belting to both sides of the foam core, creating a stiff laminate. Like the wooden version, make deep saw cuts parallel to the length of the sanding board, going through the first skin and core but not into the second skin.

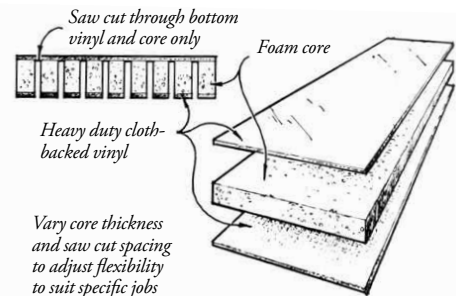

Belting materials, core thickness and cut spacing can be varied to achieve different results for specific jobs. Sizes can range from 1" thick by 6" wide by 36" long, to much smaller versions $\frac{1}{4}$ " thick by 1" wide by 2" long. A thickness that works well for $\frac{1}{3}$ to $\frac{1}{2}$ sheet of sandpaper is $\frac{1}{2}$ " thick, made of $\frac{3}{8}$ " thick foam core separated by two layers of belting. These sanding blocks work particularly well with adhesive-backed sandpaper.

Making a fairing file

Hacksaw blades can be modified and used for fairing. Sanding the cured epoxy with sanding boards can be slow work. A new hacksaw blade will easily cut through the low-density filler and occasional high spots in the fiberglass.

Clamp the hacksaw blade between two $\frac{1}{4}$ "-thick wooden strips. The strips provide a handle and add stiffness to the blade, but are flexible enough to bend slightly over curved surfaces. Round the corners of the wooden strips with sandpaper, to make it comfortable to hold. Hold the blade and strips together with epoxy or G/5, Five Minute Adhesive. Keep the glue out of the saw teeth while bonding the wooden strips to the saw blade.

For surfaces with lots of curve, add thinner strips of wood to each side of the hacksaw blade. If it's still too stiff, a few strokes of a hand plane on each side will fine tune flexibility.

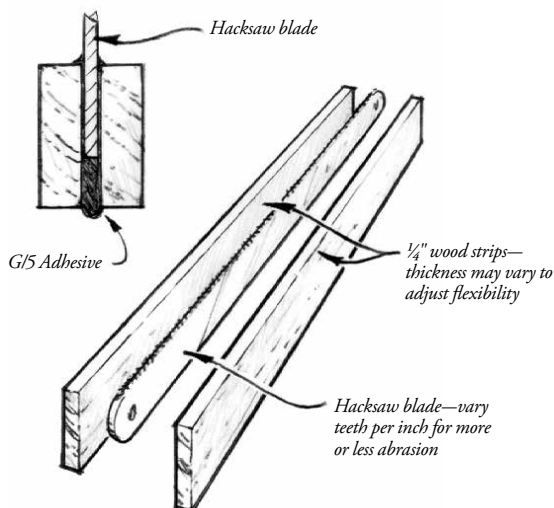

Some industrial or power hacksaw blades may be stiff enough to use without adding wood. When doing a lot of fairing, it is helpful to have a variety of these tools, to allow a change of handholds to reduce fatigue.

Just like sandpaper, hacksaw blades offer differing abrasive qualities. A 6 to 10 TPI (teeth per inch) blade will offer good coarse fairing capability. A 16 to 20 TPI blade offers medium fairing capability and the 28 to 32 TPI offers fine fairing capability.

To work this modified tool effectively, hold it so the saw teeth are against the surface to be faired. Lean the tool over slightly at a 10° to 20° angle and push the tool across the surface in a direction that is diagonal to the length of the tool. Avoid pushing in a direction parallel to the tool length, because the saw blade will cut a slot in the surface. Think of the modified saw as a file that is used in a diagonal direction to maximize the cut. Experiment with the angle at which you push or pull the tool across the surface.

As with sandpaper, it is best to fair the surface in opposing directions on a diagonal. To do this, turn the saw around so the teeth are facing the other direction and repeat the fairing process working in the opposite direction. Fairing in opposing directions will quickly establish a fair surface and help to better maintain fairness.

Making a batten

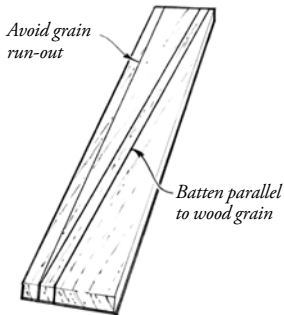

The simplest battens are produced from straight-grained softwood like pine or fir. Select stock with no grain run-out and cut the batten parallel to the grain, rather than the edge of the stock. You may need several battens of different lengths and cross sections if you are fairing a large hull or a variety of surfaces. A long batten may be between $\frac{3}{4}$ " and $1\frac{1}{4}$ " square (depending of the flexibility of the wood and the shape of the hull) and as long as the length of the hull. It should be thin enough to conform to the overall shape, but stiff enough to bend in a fair curve. A short batten, up to 6' long, is useful for fairing smaller areas. It may be up to $\frac{3}{4}$ " square or as thin as $\frac{1}{4}$ " x $\frac{3}{4}$ " to conform to tighter curves, such as the turn of the bilge. If joining shorter lengths of wood to make a long batten, use long scarf joints (20:1) to avoid hard spots. Painting the batten a flat color can reduce any visual deception from the wood grain

Moisture Meters

There are several non-destructive meters available to measure the relative moisture level in fiberglass laminate. These meters work by measuring the resistance of electrical signals transmitted through the laminate. The level of moisture within the laminate affects the level of resistance. Keep in mind that these readings can indicate relative dryness at different locations, and not accurate true measurements of the moisture content throughout the laminate. Moisture meters are available from:

J.R. Overseas Co., P.O. Box 370, Kent, CT 06757, USA
(502) 228-8732 jroverseas.com



Gelcoat Sprayers

For small areas of gelcoat or paint finishing, as described in Section 2.2, the Preval® Auto Sprayer is a handy, self-contained, reusable sprayer. Holds up to 16 oz. of custom mixed paints or gelcoats. It can be purchased at automotive paint supply stores. Precision Valve Corporation, Yonkers, NY10703.

Fairing fillers

WEST SYSTEM 407 Low-Density and 410 Microlight™ fillers are blended to create fairing compounds when mixed with epoxy. 407 filler is a phenolic microballoon based mixture. It sands and carves easily when cured, and is strong enough to be used in some structural applications. 407 can be mixed to a stiffer consistency than 410. 410 Microlight is about three times lighter and about 25% easier to sand than 407. It mixes easier and is more economical. However, 410 is not recommended under dark paint or other surfaces subject to high temperatures. 407 filler is a better choice for thicker applications or applications requiring more impact or abrasion resistance.

Fairing compound is generally mixed to the consistency of peanut butter. The more filler added to the epoxy—the stiffer the mixture and the easier it is to sand. Because epoxy is thinner at higher temperatures, it takes more filler to make a specific consistency at higher temperatures than it does at lower temperatures.

Mixing large quantities

Use the above guide as a starting point for determining the proportion of epoxy and filler. Increase quantities of mixed epoxy and filler proportionately. Monitor and record quantities and modifications so workers have a gauge to assure greater accuracy and speed of mixing. Mixing and applying large quantities of epoxy requires an efficient, coordinated operation.

First, stir resin and hardener thoroughly in a mixing pot. Then pour the mixed epoxy over an equal volume of filler in a container that holds at least four times the volume of the mixed epoxy. Using a stiff wooden paddle, stir the mixture until it reaches a smooth consistency. Continue stirring and adding filler, gradually thickening the mixture. When you arrive at stiff (peanut butter) consistency, dump the material onto a 2' x 2' piece of scrap ½" thick plywood. Spread the fairing compound out on the plywood to make it easier to see dry or unmixed areas and allow you to better judge the consistency. This also increases the material's surface area, allowing heat to dissipate and providing more working time. Use 206 or 209 Hardener to provide more working time at room temperature or adequate working time at warmer temperatures. Apply the mixture as soon as possible after mixing.

Filler	Package Size	Quantity of Mixed Epoxy Required for		
		"Catsup" Consistency	"Mayonnaise" Consistency	"Peanut Butter" Consistency
407-5	4.0 oz	.5 qt	.4 qt	.3 qt
407-15	12.0 oz	1.7 qt	1.3 qt	1.0 qt
407-B	14.0 lb	6.0 gal	4.8 gal	3.7 gal
410-2	2.0 oz	1.2 qt	.9 qt	.7 qt
410-7	5.0 oz	3.0 qt	2.4 qt	1.8 qt
410-B	4.0 lb	8.9 gal	7.2 gal	5.6 gal

Lofting foil shapes for rudders and keels

Whether you are going to build an airfoil from scratch or fair an existing foil with a template as described in the Template guide method in Section 14.3.5, you have to establish the section profile accurately.

Airfoils are cambered sections that are designed to produce lift (with minimum drag) as they operate in a fluid (air or water). Certain sections produce the most lift with the least amount of drag for given conditions of fluid density and foil speed.

When a designer chooses a foil section for a particular design, that section is often not produced to a close tolerance. Optimization of the airfoil section translates into measurable performance and handling benefits.

Airfoil sections of all NACA (National Advisory Committee for Aeronautics) families are obtained from dimensions off the centerline from specific station points. Station points begin at zero at the nose. The stations are spaced more closely in the forward third of the foil section's chord length. This area carries more shape, thus requiring more reference points to define it.

Chord line is defined as the straight line connecting the leading and trailing edges (or centerline). Station locations are expressed as a percentage, measured from the forward #0 station of the chord line. Chord thickness is described as a percentage of chord line, measured in half breadths at a particular station.

x (percent c)	y (percent c)	$(v/V)^2$	v/V	$\Delta v_d/V$
0	0	0	0	1.988
.5	0.640	0.800	1.475
1.25	1.894	1.010	1.005	1.199
2.5	2.615	1.241	1.114	0.934
5.0	3.555	1.378	1.174	0.685
7.5	4.200	1.402	1.184	0.558
10	4.683	1.411	1.188	0.479
15	5.345	1.411	1.188	0.381
20	5.737	1.399	1.183	0.319
25	5.941	1.378	1.174	0.273
30	6.002	1.350	1.162	0.239
40	5.803	1.288	1.135	0.187
50	5.294	1.228	1.108	0.149
60	4.563	1.166	1.080	0.118
70	3.664	1.109	1.053	0.092
80	2.623	1.044	1.022	0.068
90	1.448	0.956	0.978	0.044
95	0.807	0.906	0.952	0.029
100	0.126	0	0	0
L.E. radius: 1.58 percent c				

1. Establish overall chord line length (c); our example is 24".

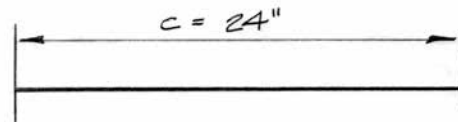

2. Refer to NACA 0012 Basic Thickness Form. Calculate and mark the station locations (x) which are a percentage of the overall chord line length, measured from 0%.

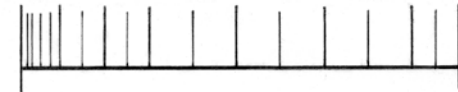

3. Calculate and mark the y dimensions (thickness from the chord line) at each station.

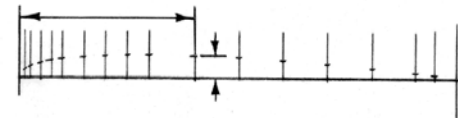

4. Duplicate the y dimension points on the other half of the foil.



5. Connect the plotted points with a batten or ship's curve.

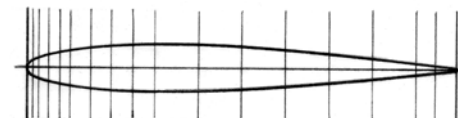

6. Lay out the leading edge line. The actual line is a 90 degree segment of a circle drawn tangent to #0, bisected by the chord line. Its radius is 1.58% of the chord line length (c).

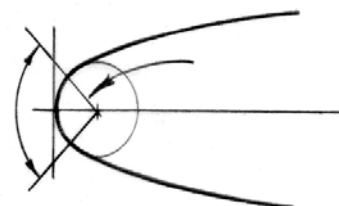

Techniques for bonding and coating at low temperatures

Epoxy can be used under cold weather conditions, but you must use special application techniques. These precautions are not elaborate or difficult, but they are necessary to achieve acceptable long-term epoxy performance. These precautions do not apply to WEST SYSTEM Epoxy alone; any epoxy used in critical marine structural situations may have its capabilities and performance affected by cold weather. In fact, due to differences in formulation, not all epoxies possess the necessary characteristics to ever cure well under cold weather conditions.

Chemical characteristics

When you mix an epoxy resin and hardener together, you start a chemical reaction which, as a byproduct, produces heat. This is called an exothermic reaction. The ambient temperature in which an epoxy chemical reaction takes place affects the rate of reaction. Warmer temperatures accelerate the reaction time, while cooler temperatures retard it.

Duration of reaction, among other variables, influences inter-bonding of the epoxy molecules. If the reaction is too slow, even though the epoxy may harden, it may not cure completely and possibly never achieve its designed physical properties. This is where danger lies, for improperly cured epoxy may possess enough strength to hold a structure together, yet it may fail after repeated loadings during normal operation.

Working properties

Temperature has a profound effect on the working properties of uncured epoxy. Ambient temperature changes will drastically change the epoxy's viscosity (thickness). Viscosity of water varies little with temperature changes until it either boils or freezes. Epoxy, however, is made of heavier molecules and temperature can have a 10 times greater effect on epoxy molecules than on water molecules over a temperature change of 30°F (16°C).

The colder it gets, the thicker the epoxy becomes, reducing its ability to flow out. This kind of change has three important consequences for working with epoxy under cold conditions.

First, it is more difficult to mix the resin and hardener thoroughly: the resin flows through the dispensing pumps and out of containers with greater difficulty; the cold resin and hardener are prone to clinging to the surfaces of the pumps, containers and mixing tools; and they resist being completely blended unless mixed very thoroughly. Remember, because of the low temperature, the chemical reaction isn't going off as well either.

Compounding a less efficient exothermic reaction with potential for incomplete and/or inaccurate mixing, you have the recipe for a permanently deficient bond.

Second, the mixed epoxy is much harder to apply. If you've ever tried to spoon honey right out of the refrigerator instead of at room temperature, you know just what we're referring to: the chilled mixture has become stiff. When cold temperatures make epoxy stiff, it's extremely difficult to coat and wet out surfaces.

Third, air bubbles may be introduced when mixing and held in suspension due to the chilled epoxy's increased surface tension. This can be especially troublesome in clear-finish applications.

Cold weather techniques

Up to this point, we've told you all of the reasons why cold weather epoxy usage is difficult and potentially dangerous. However, with a little advance planning and certain simple precautions, all of these problems can be addressed and their consequences avoided. The following are six basic cold weather rules. We've used these guidelines for over 20 years and have yet to experience a cold weather curing problem with WEST SYSTEM Epoxy.

1. Use WEST SYSTEM 205 Fast Hardener.

WEST SYSTEM 205 Hardener has been designed with a chemically-activated polyamine system which exhibits a good cure as low as 35°F (1.5°C). It exhibits a faster cure characteristic than 206 Slow Hardener and offers less uncured exposure time which reduces the chances of incomplete cure due to cold temperatures.

2. Dispense resin and hardener in the proper mixing ratio.

All epoxies have been formulated for a specific mixing ratio of resin to hardener. It is important to mix your epoxy in the precise ratio recommended by the manufacturer. Increasing the amount of hardener will not accelerate cure, but it will seriously compromise the epoxy's ultimate strength. WEST SYSTEM Mini Pumps are designed and calibrated to dispense the correct ratio with one pump stroke of resin for every one pump stroke of hardener.

3. Warm resin and hardener before using.

As we discussed above, the warmer the resin and hardener, the lower the viscosity. Thinner resin and hardener will flow through mechanical pumps better, cling less to containers and mixing equipment, and exhibit superior handling and wet-out characteristics. The epoxy can be warmed using heat lamps or can simply be kept in a warm area until you are ready to use it. Another simple method of warming the resin and hardener is to construct a small hot box out of rigid sheets of foil-backed insulation. Place a regular light bulb or an electric heating pad inside to maintain a temperature of no greater than 90°F (32°C).

4. Stir the resin and hardener thoroughly.

Use extra care when mixing the resin and hardener, and mix for longer than normal periods of time. Scrape the sides and bottom of the mixing container, using a flat-ended mixing stick to reach the corners. Using a smaller diameter mixing pot will also improve the chemical activity because the limited surface area will not dissipate heat produced by the reaction.

5. Warm working surfaces.

Applying warmed epoxy to a cold structure will quickly retard the molecular bonding activity of the epoxy. Be certain the structure, as well as the area surrounding the structure, is brought up to temperature. A hull, for example, which is colder than the surrounding air may experience condensation and result in water contamination to epoxy applied on it. Warm the structure as much as possible. This can be done by constructing tents around small areas and heating with portable heaters or warming the area with hot air guns or heat lamps. Small components or materials (such as fiberglass cloth) can be warmed before use in a hot box as described above.

6. Prepare surfaces carefully between applications.

When coating under cold conditions, a thin film of epoxy often dissipates any exothermic heat generated by the reaction. When heat is dissipated quickly, the epoxy may not cure for an extended period of time. Some reaction with water may occur, resulting in the formation of an amine blush on the surface. Immediately prior to applying subsequent coatings, wash the surface with clean water and allow it to dry thoroughly.

Cold weather storage

It is best to store WEST SYSTEM materials above 35°F (1.5°C) with the container caps screwed down tightly. Storing epoxy in extreme cold may cause crystallization. The formation of crystals does not compromise the epoxy and can be remedied. Boil water in a pot large enough to hold your epoxy containers. Remove each container's lid to avoid pressure buildup, which may cause the cans to burst, and place the cans in the hot water. Continually stir the epoxy with a clean stick until the liquid regains clarity and all crystals have melted. Remove from the water, replace the lids tightly and invert the container to melt any crystals which may be clinging to the top of the container. If the resin pump has crystallized, pumping warm resin through it should dissolve the crystals.

Additional reading

Blackwell, E., D. Jones and A. Wolfe. "Marine Composite Structures, Failures and their Causes." BJ&A, Inc., 6281 39th Street North, Suite B, Pinellas Park, FL 34665.

Burrell, P.P., D. J. Herzog and R. T. McCabe. "A Study of Permeation Barriers to Prevent Blisters in Marine Composites and a Novel Technique for Evaluating Blister Formation." SPI Reinforced Plastics/Composites Institute, 42nd Annual Conference, 1987.

Curry, B. "The Effects of Gelcoat Composition on Osmotic Blister Formulation." SPI Reinforced Plastics/Composites Institute, 42nd Annual Conference, 1987.

Florio, J., V. C. Rose and T. J. Rockett. "Effects of Selected Manufacturing Procedures on Water Resistance of Marine Laminates." SPI Reinforced Plastics/Composites Institute, 42nd Annual Conference, 1987.

Hulden, Margareta and Charles M. Hansen. "Water Permeation in Coatings." PROGRESS IN ORGANIC COATINGS, 13(3-4), 171-94.

Marshall, J.M. and R. F. Pinzelli. "The Diffusion of Liquids into Resins and Composites." SPI Reinforced Plastics/Composites Institute, 37th Annual Conference, 1982.

Marshall, J.M. "The Diffusion of Water and Hydrochloric Acid into Glass Reinforced Vinyl Ester Laminates." SAMPE QUARTERLY, July 1982.

Reference Series. "Blisters, Professional Boatbuilder Magazine's Guide to Understanding, Preventing, and Repairing Them." 1994, Professional Boatbuilder Magazine, P.O. Box 78, Brooklin, ME 04616.

Strand, R. "Blisters under the Microscope." PRACTICAL SAILOR. May 1, 1990, 8-10.

Strand, R. "New Insights into Hull Blistering." PRACTICAL SAILOR. February 15, 1990, 10-15.

Appendix B

Estimating guides for WEST SYSTEM products

Group size quantities and coating coverage

WEST SYSTEM® Epoxy resin and hardeners are packaged in three “Group Sizes.” For each container size of resin, there is a corresponding sized container of hardener and a corresponding mini pump size. When purchasing resin, hardener and mini pumps, be sure all containers are labeled with the same Group Size letter (A, B or C).

Group Size	Resin Quantity	Hardener Quantity	Mixed Quantity	Saturation Coat Porous Surfaces	Build-up Coats Non-Porous Surfaces
A	105-A 1 qt. (.94 L)	205-A or 206-A .43 pt. (.20 L)	1.2 qt. (1.15 L)	90–105 sq. ft. (8.5–10m ²)	120–135 sq. ft. (11–12.5 m ²)
		207-A or 209-A .66 pt. (.31 L)	1.3 qt. (1.26 L)	90–105 sq. ft. (9–10 m ²)	120–135 sq. ft. (11–13 m ²)
B	105-B .98 gal (3.74 L)	205-B or 206-B .86 qt. (.81 L)	1.2 gal. (4.55 L)	350–405 sq. ft. (32–37 m ²)	462–520 sq. ft. (43–48 m ²)
		207-B or 209-B 1.32 qt. (1.24 L)	1.3 gal. (4.98 L)	370–430 sq. ft. (35–40 m ²)	490–550 sq. ft. (45–50 m ²)
C	105-C 4.35 gal (16.47 L)	205-C or 206-C .94 gal (3.58 L)	5.29 gal. (20 L)	1530–1785 sq. ft. (142–165 m ²)	2040–2300 sq. ft. (190–213 m ²)
		207-C or 209-C 1.45 gal (5.49 L)	5.8 gal. (21.9 L)	1675–1955 sq. ft. (155–180 m ²)	2235–2520 sq. ft. (207–233 m ²)

Filler/epoxy proportion guide

Approximate mixed epoxy required to produce a catsup, mayonnaise or peanut butter consistency for the various sized filler products at 72°F. Mixtures will be thinner at higher temperatures.

Filler	Package Size	Quantity of Mixed Epoxy Required for		
		“Catsup” Consistency	“Mayonnaise” Consistency	“Peanut Butter” Consistency
403-9	6.0 oz	3.8 qt	2.5 qt	1.0 qt
403-28	20.0 oz	3.2 gal	2.0 gal	.9 gal
403-B	20.0 lb	48.0 gal	32.0 gal	15.3 gal
404-15	15.2 oz	1.2 qt	.9 qt	.7 qt
404-45	45.6 oz	3.6 qt	2.8 qt	2.0 qt
404-B	30.0 lb	9.4 gal	7.4 gal	5.3 gal
405	8.0 oz	.9 qt	.7 qt	.6 qt
406-2	1.9 oz	1.3 qt	.9 qt	.5 qt
406-7	6.0 oz	1.1 gal	3.0 qt	1.7 qt
406-B	10.0 lb	27.0 gal	16.0 gal	6.0 gal
407-5	4.0 oz	.5 qt	.4 qt	.3 qt
407-15	12.0 oz	1.7 qt	1.3 qt	1.0 qt
407-B	14.0 lb	6.0 gal	4.8 gal	3.7 gal
410-2	2.0 oz	1.2 qt	.9 qt	.7 qt
410-7	5.0 oz	3.0 qt	2.4 qt	1.8 qt
410-B	4.0 lb	8.9 gal	7.2 gal	5.6 gal

Adhesive fillers vs. fairing fillers

Fillers are used to thicken the basic resin/hardener mixture for specific applications. Each filler possesses a unique set of physical characteristics, but they can be generally categorized as either Adhesive (high-density) or Fairing (low-density). Adhesive filler mixtures (403, 404, 405 and 406) cure to a strong, hard-to-sand plastic useful in structural applications like bonding, filleting and hardware bonding. Fairing filler mixtures (407 and 410) cure to light, easily sandable material that is generally used for cosmetic or surface applications like shaping, filling or fairing. Seal all faired surfaces with epoxy before painting.

Fiberglass metric conversions

- 4 oz/yd² = 135.6 g/m²
- 6 oz/yd² = 203.4 g/m²
- 9 oz/yd² = 305.2 g/m²
- 10 oz/yd² = 324 g/m²

Fiberglass Thickness Per Layer

Product number	740	742	713	702	729, 731, 732, 733	745	727, 737	738
Fabric weight	4 oz.	6 oz.	11 oz.	11 oz.	9 oz.	12 oz.	15 oz.	22 oz.
Single layer thickness*	.006"-.008"	.009"-.011"	.016"-.021"	.015"-.018"	.013"-.017"	.014"-.019"	.025"-.032"	.039"-.053"

*Average of multiple layers applied by hand lay-up

Estimated Epoxy Coverage for Fabric Application

Fabric Product Number	Fabric Weight per yd ²	Mixed Epoxy Needed to wet out 1 ft ² of fiberglass and apply 2 fill coats
740	4 oz.	1.4 fl.oz.
742	6 oz.	1.61 fl.oz.
729, 731, 732, 733	9 oz.	1.94 fl.oz.
745	12 oz.	2.05 fl.oz.
727, 737	17 oz.	2.81 fl.oz.
738	23.8 oz.	3.55 fl.oz.

*Includes 15% waste factor.

Estimated Epoxy Coverage for Gelcoat Blister Repair and Coating

Product	Length of Boat				
	20 ft.	25 ft.	30 ft.	35 ft.	45 ft.
	(100 sq. ft.)	(200 sq. ft.)	(300 sq. ft.)	(400 sq. ft.)	(500 sq. ft.)
Gallons of resin, plus hardener (Group Size B)	1	2	3	4	5
Mini Pumps	1 pair	1 pair	1 pair	1 pair	1 pair
407 Low-Density					
No bottom blistering. Faring not required	0	0	0	0	0
Moderate Blistering. Minor Fairing required.	18 oz.	27 oz.	36 oz.	54 oz.	108 oz.
Severe blistering. Extensive fairing required.	36 oz.	54 oz.	72 oz.	108 oz.	216 oz.
or 410 Microlight					
No bottom blistering. Faring not required	0	0	0	0	0
Moderate Blistering. Minor Fairing required.	6 oz.	9 oz.	12 oz.	18 oz.	36 oz.
Severe blistering. Extensive fairing required.	12 oz.	18 oz.	24 oz.	36 oz.	72 oz.
Solvent	1 qt.	1 qt.	2 qt.	3 qt.	1 gal.
422 Barrier Coat Additive	32 oz.	64 oz.	96 oz.	128 oz.	160 oz.
Gloves	12 pair	12 pair	24 pair	24 pair	36 pair
Roller Covers	6	6	12	12	24
Roller Frames	2	2	2	4	4
Squeegees					
No bottom blistering. Faring not required	0	0	0	0	0
Moderate Blistering. Minor Fairing required.	2	2	2	4	4
Severe blistering. Extensive fairing required.	4	4	4	4	4
Mixing Pots	6	6	6	6	6
Mixing Sticks	12	12	24	24	36

Estimates are based on a moderate displacement sailboat. For full keel boats or power boats, add approximately 10% to the product quantity. Quantities assume a 5 or 6 coat buildup. You may find it more economical to purchase supplies in larger quantities. Your actual usage may vary.

Epoxy handling

Shelf life

If the containers are kept sealed when not in use WEST SYSTEM resin and hardeners should remain usable for many years. Over time, 105 Resin will thicken slightly and will therefore require extra care when mixing. Hardeners may darken with age, but physical properties are not affected by color. Mini Pumps may be left in containers during storage. It is a good idea, after a long storage to verify the metering accuracy of the pumps and mix a test batch to assure proper curing before applying epoxy to your project.

Low temperature considerations

When using WEST SYSTEM Epoxy at low temperatures, special precautions can be taken to assure maximum performance. For detailed information on working with epoxy at low temperatures, refer to Appendix A. Visit westsystem.com for information on this and other supplemental WEST SYSTEM publications.

Thinning epoxy

There are epoxy-based products specifically designed to penetrate and reinforce rotted wood. These products, basically an epoxy thinned with solvents, do a good job of penetrating wood, but the solvents compromise the strength and moisture barrier properties of the epoxy. WEST SYSTEM Epoxy can be thinned with solvents for greater penetration, but not without the same compromise in strength and moisture resistance. Acetone and lacquer thinner have been used to thin WEST SYSTEM Epoxy and duplicate these penetrating epoxies with about the same effectiveness. If you choose to thin the epoxy, keep in mind that the strength, especially compressive strength, and moisture protection of the epoxy are lost in proportion to the amount of solvent added.

There is a better solution to get good penetration without losing strength or moisture resistance. We recommend moderate heating (up to 120°F) of the repair area with a heat gun or heat lamp before applying epoxy. On contact with the warmed wood, the epoxy will thin out, penetrating cavities and pores, and will be drawn even deeper into pores as the wood cools. Although the working life of the epoxy will be considerably shortened, slower hardeners (206, 207, 209) will have a longer working life and should penetrate more than 205 Hardener before they begin to gel. When the epoxy cures it will retain all of its strength and effectiveness as a moisture barrier, which we feel more than offsets any advantages gained by adding solvents to the epoxy.

Appendix C

Applying fiberglass overhead

The prospect of having to fiberglass the bottom of a hull can be a bit ominous. Any type of overhead work can be frustrating, but the thought of trying to hold fiberglass in place while applying epoxy can produce nightmares for some people. This is especially true if you will be working alone.

You can fiberglass overhead alone without going crazy in the process. Having faced this demon in the past we struggled until we found a relatively easy method. The technique is similar to hanging wallpaper. We trim the dry fiberglass fabric into narrow strips like wallpaper and wet it out on a flat surface. Then we roll the wet fabric onto cardboard tubes, carry them to our project and unroll them onto the prepared overhead surface.

Here's a more detailed plan for fiberglassing overhead.

1. Precut fiberglass into sizes required for your project. Cut the fiberglass into manageable widths of 24"–30" (half of a standard 4' or 5' wide roll). Roll the dry fiberglass onto cardboard tubes (or sections of PVC plastic pipe) that are 3"–4" in diameter. Plan to orient the fabric strips vertically, working from the top down. Gravity will work in your favor if you apply the fabric this way. Label the fiberglass rolls so you'll know where to locate them later.
2. Prepare the surface of the project for epoxy. Be sure the surface is clean and freshly sanded.
3. Prepare a fiberglass wet out bench. This can be any flat surface such as an old door or plywood panel that is covered with plastic. Ideally the surface should be at least as wide as the fabric, and located close to your project. Having it nearby will help reduce the time between when you apply the epoxy to the fiberglass and when you unroll it onto the project.
4. Apply a coat of unthickened epoxy to the hull but only to as much area as can be fiberglassed before the epoxy gels (Figure 1). When working overhead, it is especially important to wear goggles, gloves and protective clothing to keep epoxy off of your skin, hair and eyes.



Figure 1 Apply a coat of unthickened epoxy to the hull.



Figure 2 Wet out the fabric by pouring epoxy onto it and spreading it out with a plastic spreader

5. Unroll a single piece of fiberglass cloth onto the plastic covered bench. Wet out the fabric by pouring epoxy onto it and spreading it out with a plastic squeegee (Figure 2). Apply a generous coat to ensure thorough wet out of the fibers, but don't use too much because you've already coated the overhead project. Additional epoxy adds weight, increasing the fabric's tendency to fall or slide off.

6. Roll the wet fiberglass fabric onto the pre-cut tubes to allow ease of handling. Carry the fiberglass covered tube to the project quickly. Epoxy generates heat when confined in mass. There is a limited amount of time to apply the fabric before exotherm (excessive heat build-up) occurs. This can result in epoxy-coated fiberglass curing on the tube.
7. Carefully position the fiberglass roll at the point you've chosen to start. It's generally a good idea to start high and work low. Unroll 6" of fiberglass from the roll. Press the fabric against the hull. It should stick to the epoxy coated surface without pulling away. Unroll the fiberglass/cardboard tube onto the surface with one hand. Use the other gloved hand to spread out wrinkles and press the fabric against the surface, removing air (Figure 3).
If the roll is not tracking where you'd like, roll some of the fiberglass strip back onto the tube. This will enable you to redirect the fabric slightly by shifting the short section still attached to the hull. Unroll the fabric again making slight adjustments for position along the way. Use the tube like a rolling pin to press the fabric into the surface. Pick up the roll from the surface to stretch the fabric occasionally. This will minimize wrinkles and make the going easier.



Figure 3 *Unroll the fiberglass onto the surface with one hand—spread out wrinkles and press the fabric against the surface with the other.*

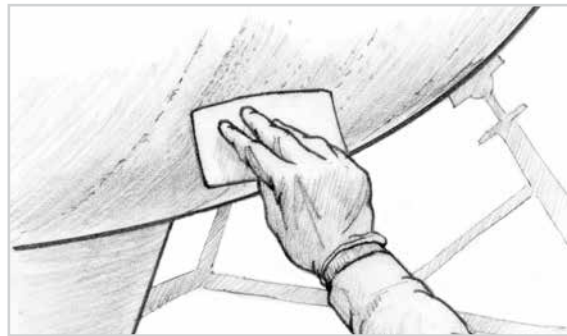

Figure 4 *Use a plastic squeegee to press the fabric securely against the hull.*

Light-weight fabrics will have no trouble clinging to a recently coated surface. Heavier fabrics may require an extra step to get the fabric to stay put. If necessary, after the wet out coat apply a light coat of epoxy that has been thickened with 404 High Density filler or 406 Colloidal Silica filler to the hull before applying heavier fabrics. The layer of thickened epoxy gives the wet fiberglass something to nest into.

8. After applying the fiberglass strip, use a plastic squeegee to press the fabric securely against the hull (Figure 4). Use this step to draw off excess epoxy and force out trapped air bubbles. If additional layers of fiberglass are required, repeat the process. Apply additional layers while the previous layer is still tacky. This saves time and eliminates the normal wash and sand step required if the epoxy were allowed to cure hard between coats.

You can apply multiple layers of fiberglass like shingles on a roof. The first piece of the second layer should be narrower than the piece below it, followed by normal width strips, so that all of the joints are staggered. Stagger the layers so each edge falls at least 3" from the nearest edge below or above it. The individual strips can usually be butted because the adjoining layer laps the butt joint. Apply all of the strips using the techniques described above. Repeat the process until the hull is covered.

This technique allows you to stop and start without causing a problem. If you get tired, take a break before wetting out the next piece of fabric. Just be sure to get back on it with additional layers while the previous layer is still tacky. If the epoxy will be past the tacky cure before you get back, consider applying release fabric to the areas. This saves the wash and sand surface prep normally required for bonding to a cured surface.

If it looks like the epoxy will cure too far before you can apply the remaining fiberglass strips, you can buy more re-coat time by rolling on a fresh coat of epoxy while the previous coat is still a bit tacky. The period when a curing epoxy surface or coating is still tacky is the ideal time for applying subsequent layers of epoxy, fiberglass, or epoxy fairing putties.

Appendix D

Repairing machined holes in fiberglass laminate

First, we will classify the types of holes we are discussing as ones that are round and have been machined, probably with a drill, as opposed to punctures and cracks incurred from damage. The reasons they may need to be repaired are numerous: refitting, resizing, removing obsolete equipment, or mistakes. When repairing fiberglass boats, the challenge is to determine an appropriate repair strategy. You want a repair that is safe and adequate, but also realistic. You want to ensure that the repair is strong enough for the anticipated worst-case load and err on the side of being conservative. Other things to consider include the costs in time and money and the skill required to perform the repair.

Few repairs are identical, and many variables can influence the appropriate repair strategy. In a best-case scenario, a repair can be very simple: force thickened epoxy to fill the hole, scrape it flush, and allow the epoxy to cure. At the other extreme, a repair of structural fiberglass might involve grinding both sides, bonding in reinforcing fibers, sanding the

entire repair flush, gelcoating, and finishing to a high gloss. The first job could take ten minutes and the latter many hours, if not days. There is no tidy repair sequence for all hole repairs. First, you need to think carefully about each hole. The chart above and this discussion of different types of repair strategies from the simplest to the most complex can help you decide the best repair strategy for most hole repairs.

Use this chart by finding a vertical line on the graph that balances both hole diameter and laminate thickness. Determine the consequences of repair failure and find a horizontal line that represents the level of risk. Where the lines intersect will determine the importance of repair strength. Repairs that are in the upper right corner need to be done very conservatively, and repairs that are in the lower left corner can place a lower emphasis on strength. The chart also demonstrates the relationship between thickness and hole diameter. A hole with a large diameter is more highly stressed in a thin laminate than in a thick laminate.

Figure 1
Hole Repair Chart

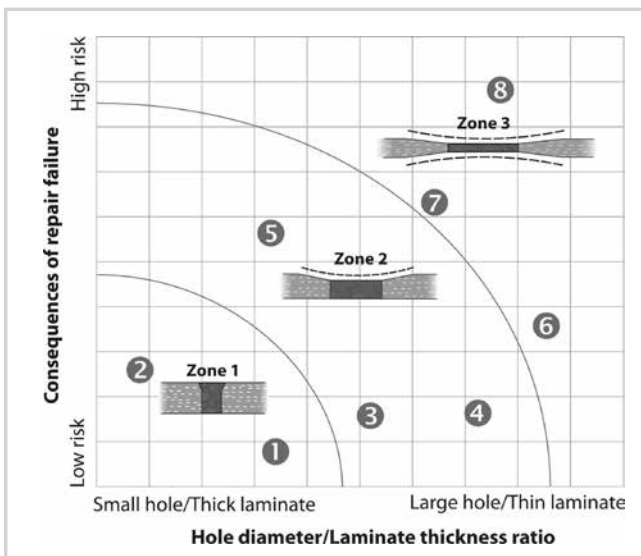

Zone 1—Low-risk repairs using thickened epoxy

The following two examples can be repaired with thickened epoxy because their characteristics put them in the lower left-hand corner of the chart. They require no additional fiberglass reinforcement.

Example 1

A #8 self-tapping screw, just over $\frac{1}{8}$ " (3 mm) diameter, is removed from the deck of a boat. The deck is $\frac{1}{8}$ " (3 mm)-thick fiberglass skin with a plywood core.

This is a low-risk repair. The hole is small in diameter, the skin is relatively thick compared to the hole diameter, and the skin is backed by

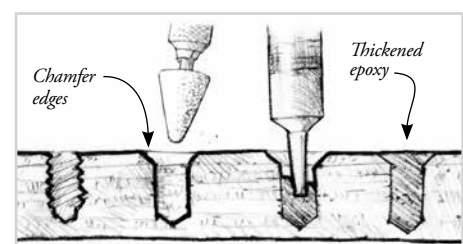

dense core material, plywood. If this repair fails, the worst thing that will happen is the plywood core may rot someday.

To begin the repair, ream the hole with a drill bit slightly larger than the existing hole to expose clean, fresh laminate and wood. Then chamfer the hole with a countersink. Do this on both sides of the hole if you can reach the backside. The chamfer softens the sharp edge left from the reaming operation so the repair is less likely to telegraph through the final finish. Additionally, when the hole is chamfered on both sides, a mechanical lock is formed when the hole is filled.

In thicker laminates, removing the screw may result in a blind hole, a hole that does not go completely through the laminate. In this case, use a syringe to fill from the bottom of the blind hole. If the hole is deeper than the length of a static mixer or syringe nozzle, use a soda straw to extend the length of the nozzle. Trying to force thickened epoxy into a blind hole with a putty knife always leaves an air bubble at the bottom of the hole. Filling from the bottom forces all air out of the hole.

Use Six10 Epoxy Adhesive dispensed from a static mixer or 105 Resin/hardener thickened with 404 High-Density filler or 406 Colloidal Silica filler and dispensed with a 807 Syringe. Fiberglass laminate is hard and strong and using 404 or 406 Filler creates a hard, strong epoxy filler, which more closely matches the characteristics of the laminate. A word of caution: These fillers make epoxy difficult to sand. When you fill a hole, clean up around the hole as thoroughly as possible to minimize sanding.

When using thickened 105 Resin/hardener follow the standard two-step bonding techniques. First wet out the hole with neat epoxy. Even though this hole repair example is considered a low-risk repair, any repair that has the potential to allow water into your boat deserves the best possible bonding techniques. You will be able to sleep better at night if the repair is done correctly.

Example 2

A ¼" (6 mm) diameter hole passes through the transom below the waterline. The transom has a fiberglass skin on both sides of a 2" (50 mm) thick plywood core. There is no access to the backside of the hole.

This hole has a risk factor similar to Example 1, that is, low-risk, below the waterline. It is low risk because the hole is deep and there is a lot of surface for the plug to bond to. In addition, the hole has very little surface area exposed to the water so there is very little pressure trying to push the repair through the hole. Also, the hole is not located where it will be subject to impact or pounding.

Prepare this hole by reaming and countersinking as described in Example 1. Because there is no access to the inside of the transom, you should install a plug in the hole to keep the epoxy from running through while it is curing. You can make a plug by saturating some type of absorbent material with epoxy and forcing the wet plug to the back of the hole. Cotton balls, foam ear plugs, foam rubber from a pillow, paper towel, Kleenex, or any other absorbent material will work. Once the plug is in place and at least partially cured, finish the repair.

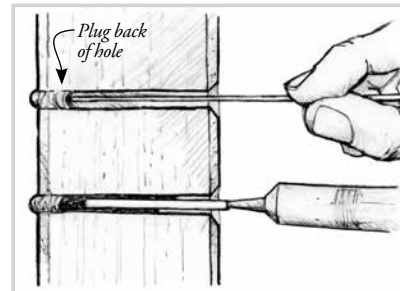

Zone 2—Medium-risk repairs using solid wood plugs and fiberglass patches

The next three examples are repaired through a combination of filling with thickened epoxy, bonding solid plugs in place, and using laminates of fiberglass. These repairs fall into the middle of the chart (see Figure 1) with some higher risks, larger holes and thinner laminates.

Example 3

A 1" (25 mm) diameter hole exists in a cockpit seat (lazarette) hatch. It's a solid ¼" (6 mm) thick fiberglass laminate with no core. The topside has a gelcoated non-skid pattern (a type of pyramid). The underside is not an issue cosmetically and is accessible by opening the hatch.

Although the safety risk is low, you want a strong repair to reduce the risk of having the seat crack in use and avoid future repairs. The most difficult part of this repair will be the time consuming work of matching the color and non-skid pattern of the gelcoat surface after the hole is filled. Sand the inside surface of the hole to expose clean laminate. Also sand a 3" (76 mm) diameter area around the hole, on the underside of the laminate. Chamfer the top lip (the gelcoated side) of the hole, about ¼" (6 mm) back, with a countersink bit or a rotary abrasive tool.

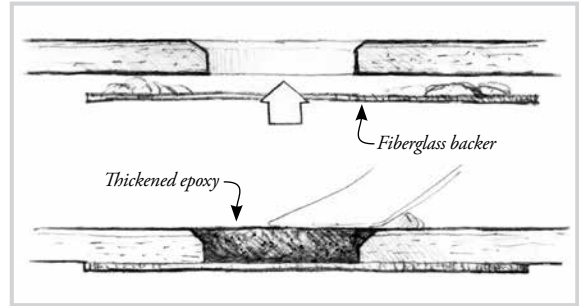

Wet out these areas by applying a coat of unthickened (neat) epoxy. Then wet out a 2½"–3" (63 mm–76 mm) diameter piece of fiberglass cloth and apply it to the sanded area on the inside of the hatch. Allow it to cure to a soft gel. Then fill the hole flush with the surface, using Six10 Epoxy Adhesive or 105 Resin-based epoxy thickened with a high-density filler. If matching the non-skid pattern is important to you, we recommend contacting Gibco Flex-Mold for flexible non-skid patterns that are available for molding the exact pattern over the repair.

Example 4

An instrument is eliminated and now a 2" (50 mm) diameter hole exists in a bulkhead, which is fiberglass with a plywood core.

Although it is a larger hole, this is not a high-risk repair since the hole has existed without weakening the boat and is not underwater.

Sand the inside of the hole to expose clean wood. Cut a 2" (50 mm) diameter wood plug that matches the thickness of the original plywood core. Then dry fit the plug to assure a loose fit. Remove the plug and sand a slight chamfer around the perimeter of the hole on both sides of the bulkhead that flares out onto the fiberglass ½" (12 mm) or so. Glue the wood plug in place with Six10 Epoxy Adhesive or 105 Epoxy thickened with 403 Microfibers. Allow it to cure to a soft gel before filling the low spots on each side of the bulkhead. Fill the low spots on each side of the plug with a layer or two of 6–10 oz. fiberglass cloth if the area will be exposed to impact or abuse.

If the area will not be highly stressed, you can fill the low spots on either side of the plywood plug with 105 Epoxy thickened with 407 Low-Density Filler or 410 Microlight™. Allow the epoxy to cure before sanding smooth, sealing with a coat of epoxy, and painting or gelcoating. Refer to Finishing, Section 2.2 for information on painting and applying gelcoat over epoxy.

Example 5

A 1" (25 mm) diameter hole drilled near the hull bottom through a structural laminated fiberglass bulkhead with a ¾" (19 mm) plywood core. Bilge water should not be allowed to flow through the hole.

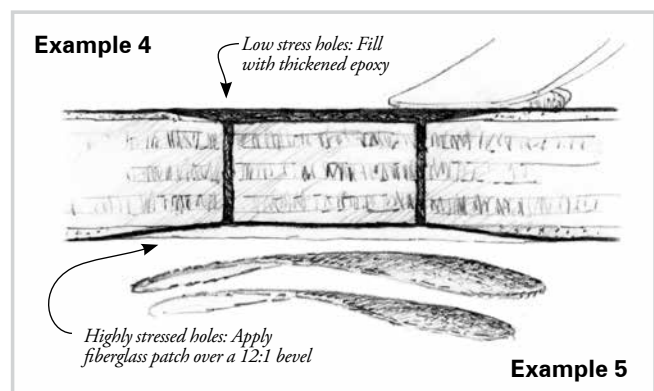

Since the repair is to a structural component and needs to be watertight, the consequences of failure are higher than the previous examples. While it is likely that simply filling this hole will provide enough strength, overlaying the plug with fiberglass will provide more strength and better sealing. What is needed here is to bond in a wood plug that is a bit

thinner than the plywood core so that once the epoxy cures you can laminate over it and maintain the original bulkhead thickness.

Fill the hole with a wood plug using the method described in the previous example and then bevel the laminate at 12:1 ratio on the edges where the new laminate will overlap onto the original. Apply enough fiberglass to match the thickness of the original laminate. Apply paint or gelcoat over the finished surface.

Zone 3—High-risk repairs requiring additional reinforcing

The final three examples describe repair procedures used when a more serious situation would result if the repair were to fail. Each repair uses some form of reinforcing material.

Example 6

A 3" (76 mm) diameter hole was mistakenly cut through the ¼" (6 mm) fiberglass liner. No access hole exists to the back side.

This repair would meet the criteria in the lower right quadrant of the chart (see Figure 1). It is a relatively large hole, and liners are generally thinner laminates even though they often provide a structural component to the hull. While the consequences of a complete repair failure would be quite low, it would still be a good idea to repair this hole by grinding a 12:1 bevel around the circumference of the hole and laminating in a layered fiberglass patch, as described in detail in our manuals.

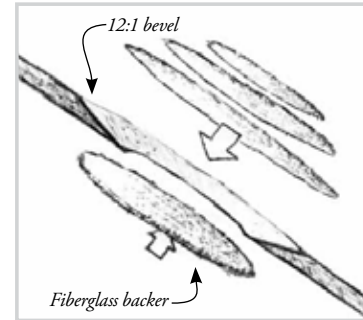

A backer plate may be necessary to keep the layers in the patch from pushing through the hole. A simple way to make a backer is to wet out a piece of lightweight fiberglass on a sheet of polyethylene plastic and allow it to cure. You can then easily cut this single thickness of glass with scissors to a size larger than the hole and bend it to fit through the hole. Bond this backer plate to the inner surface of the laminate with G/5 Five-Minute Adhesive. You can then lay the fiberglass patch in place without pushing through, squeegee it down and allow it to cure. Then prepare this surface for fairing and finishing.

Example 7

A seacock, located below the waterline, is being replaced with a smaller diameter one. There is a 2" (50 mm) diameter hole through a ½" (12 mm) thick solid fiberglass laminate. The new seacock requires a 1½" (38 mm) diameter hole. Access to the back is good. The bottom is painted with antifouling paint.

In situations like this, where the difference in hole diameter between the old and new hole is ½" (12 mm) or less and the screw pattern for the new thru-hull will be in the original laminate, you can get away with adding minimal reinforcement from one side. To do this, sand 4"–5" (10 cm–12 cm) diameter area on the backside of the hole, centered on the hole and apply the reinforcement. The reinforcement could be a laminate, a layer or two of fiberglass/epoxy, a thin layer of cured fiberglass laminate like G-10, or a ¼" (6 mm) thick piece of plywood sealed with epoxy.

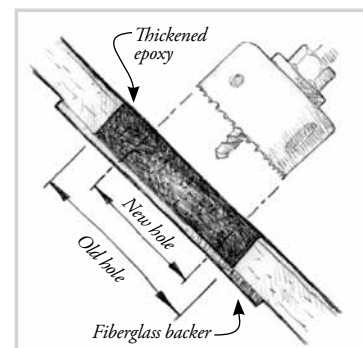

When the epoxy used in your reinforcement has gelled, fill the hole with Six10 Epoxy Adhesive or 105 Epoxy thickened with 403, 404, or 406 filler. After the thickened epoxy has cured, use a hole saw to cut the new hole. Dry fit the new thru-hull fitting, trimming the fiberglass as needed. Use the fitting as a template for locating the new screw holes. Be sure to seal all exposed fiberglass edges and drilled holes to prevent moisture from wicking into the laminate before installing the fitting with a flexible sealant like 3M™ 5200.

Example 8

A seacock that is located below the waterline is being relocated. The hole is 2" (50 mm) diameter through a solid laminate ½" (12 mm) thick. Access to the backside is good. The bottom is painted with antifouling paint.

The chart (see Figure 1) would place this repair in the upper right quadrant due to the hole's location—a hole below the waterline certainly raises the consequences if it fails—yet, because this is a machined hole and not a puncture or impact hole, the repair should be easy to accomplish. The first step is to sand the inside of the hole to expose fresh laminate.

Next, pour some mixed epoxy into a 2" (50 mm) diameter cup to form a "puck" when cured that is about ¼" to ⅜" (3 mm–4.7 mm) thick. Sand the edge of the puck and both face surfaces, and then dry fit the puck in the hole so that it is centered with regard to the thickness of the laminate. You can then bond the puck in by brushing a thickened mixture of epoxy and 406 Colloidal Silica or Six Adhesive on the inside of the hole and the edges of the puck. If the puck fits loosely and doesn't stay where placed, use duct tape to hold it in place until the epoxy cures.

Now grind back about ¼" to ⅜" (3 mm–4.7 mm) (depending on how thick the puck is) thickness from the laminate on both sides of the hole on a 12:1 bevel. This will give the beveled area about 5" (12.7 cm) diameter. Fill the beveled area on both sides with a layered fiberglass patch and epoxy. Once the patches cure, sand them and an area larger than the patch to prep for fairing and finishing. It is especially important to remove all the antifouling paint anywhere epoxy will be applied because epoxy will not stick well to most bottom paints.

By carefully weighing the particulars of the hole and the importance of the repair, you can make a sound decision on what repair method to choose.

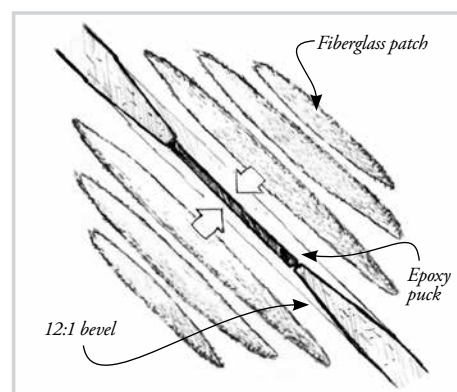

Appendix E

PROBLEM SOLVING GUIDE

This guide is designed to help identify and prevent potential problems you may encounter using WEST SYSTEM Epoxy. If the solutions described here do not resolve the problem, call the Gougeon Brothers technical staff, 866-937-8797.

PROBLEM	POSSIBLE CAUSES	SOLUTION
The epoxy mixture has not cured after the recommended cure time has passed.	Off ratio—too much or too little hardener will affect the cure time and thoroughness of the cure.	<ol style="list-style-type: none"> 1. Remove epoxy. Do not apply additional material over non-curing epoxy. See Removing epoxy, Section 16.3. 2. Check correct number of pump strokes—use equal strokes of resin and hardener. DO NOT add extra hardener for faster cure! 3. Check for correct pump (5:1 or 3:1 ratio). 4. Check pump metering ratio (see pump instructions). See Dispensing, Section 16.3.3.
	Low temperature—epoxy mixtures cure slower at low temperatures.	<ol style="list-style-type: none"> 1. Allow extra curing time in cool weather. 2. Apply heat to maintain the chemical reaction and speed the cure. Raise the temperature above the hardener's minimum recommended cure temperature. (NOTE! Unvented kerosene or propane heaters can inhibit the cure of epoxy and contaminate epoxy surfaces.) 3. Use a faster hardener, designed to cure at lower temperatures. See Controlling cure time, Section 16.3.2.
	Insufficient mixing.	<ol style="list-style-type: none"> 1. Remove epoxy. Do not apply additional material over non-curing epoxy. See Removing epoxy, Section 16.3.5. 2. Mix resin and hardener together thoroughly to avoid resin rich and hardener rich areas. 3. Add fillers or additives after resin and hardener have been thoroughly mixed. See Mixing, Section 16.3.3.
	Incorrect products.	<ol style="list-style-type: none"> 1. Remove epoxy. Do not apply additional material over non-curing epoxy. See Removing epoxy, Section 16.3.5. 2. Check for proper resin and hardener. Resin will not cure properly with other brands of hardener or with polyester catalysts.
Bond failure.	Insufficient cure.	See above.
	Resin starved joint—epoxy has wicked into porous surfaces leaving a void at the joint.	Wet out bonding surfaces before applying thickened epoxy. Re-wet very porous surfaces and end grain. See Two-step bonding, Section 16.4.2.
	Contaminated bonding surface.	Clean and sand the surface following the procedure in Section 16.4.1. Sand wood surfaces after planing or joining.
	Bonding area too small for the load on the joint.	Increase bonding area by adding fillets, bonded fasteners or scarf joints.
	Too much clamping pressure squeezed epoxy out of the joint.	Use just enough clamping pressure to squeeze a small amount of epoxy from the joint. See Clamping, Section 16.4.2.
Clear coating turned cloudy.	Moisture from condensation or very humid conditions reacts with components in uncured hardener.	<ol style="list-style-type: none"> 1. Apply moderate heat to partially cured coating to remove moisture and complete cure. See Caution! note, Section 16.3.2. 2. Use 207 Special Clear Hardener for clear coating applications and for bonding thin veneers where epoxy may bleed through to the surface.
	Entrapped air from aggressive roller application.	<ol style="list-style-type: none"> 1. Apply coating at warmer temperature—epoxy is thinner at warmer temperatures. 2. Apply epoxy in thin coats. 3. Apply moderate heat to release trapped air and complete cure. See Caution! note, Section 16.3.2.

PROBLEM	POSSIBLE CAUSES	SOLUTION
Waxy film appears on surface of cured epoxy.	Amine blush formation is a typical result of the curing process.	<ol style="list-style-type: none"> 1. Blush is water soluble. Remove with water. See Special preparation—Cured epoxy note, Section 16.4.1. 2. Use 207 Special Clear Hardener. 207 Hardener is blush free.
Runs or sags in coating.	Epoxy applied too thickly.	<ol style="list-style-type: none"> 1. Use 800 Roller Covers and roll the coating out into a thinner film. A thin film will flow out much smoother than a thicker film after it is tipped off with the foam roller brush. 2. Warm the epoxy to thin it or apply the coating at a warmer temperature. See Epoxy barrier coating, Section 16.4.6.
	Coating curing too slowly.	<ol style="list-style-type: none"> 1. Apply the coating at a warmer temperature. 2. Warm the resin and hardener before mixing to speed the cure in cool weather. 3. Switch to a faster hardener if possible. See Controlling cure time, Section 16.3.2.
Fairing compound (epoxy/407 or 410 mixture) sags and is difficult to sand.	Fairing material not thick enough.	Add more filler to the mixture until it reaches a “peanut butter” consistency—the more filler added, the stiffer and easier it will be to sand.
Thick fairing compound (epoxy/407 or 410 mixture) sags.	Fresh epoxy wet-out won't support weight of fairing.	Allow the wet-out coat to gel before applying the fairing material to vertical surfaces. See Fairing, Section 16.4.4.
Paint, varnish or gelcoat will not set up over epoxy.	Epoxy not completely cured.	Allow the final epoxy coat to cure thoroughly. Allow several days if necessary for slow hardeners at cooler temperatures. Apply moderate heat to complete the cure if necessary. See Controlling cure time, Section 16.3.2.
	Paint incompatible with epoxy.	<ol style="list-style-type: none"> 1. Use a different type of paint. Some paints and varnishes may be incompatible with some hardeners. If unsure, test for compatibility on a coated piece of scrap material. 2. Use 207 Hardener. It is compatible with most paints and varnishes.
	Epoxy surface not thoroughly prepared.	Remove the amine blush and sand the surface thoroughly before applying paints or varnishes. See Final surface preparation, Section 16.4.7.
Epoxy became very hot and cured too quickly.	Batch too large, or left in mixing pot too long.	<ol style="list-style-type: none"> 1. Mix smaller batches. 2. Transfer the mixture to a container with more surface area, such as a paint roller tray, immediately after mixing. See Controlling cure time, Section 16.3.2, Dispensing and Mixing, Section 16.3.3.
	Temperature too warm for the hardener.	Use 206 Slow or 209 Extra Slow Hardener in very warm weather.
	Application too thick.	Apply thick areas of fill in several thin layers.
Bubbles formed in coating over porous material (bare wood or foam).	Air trapped in the material escapes through coating (out-gassing) as the material's temperature is rising.	<ol style="list-style-type: none"> 1. Coat the wood as its temperature is dropping—after warming the wood with heaters or during the later part of the day. 2. Apply a thinner coat, allowing air to escape easier. 3. Tip off the coating with a roller cover brush to break bubbles. See Caution! note, Section 16.4.6.
Pinholes appear in epoxy coating over abraded fiberglass or epoxy.	Surface tension causes epoxy film to pull away from pinhole before it gels.	After applying epoxy with an 800 Roller Cover, force epoxy into pinholes with a stiff plastic or metal spreader held at a low or nearly flat angle. Re-coat and tip off coating after all pinholes are filled.
Fish-eyeing in coating.	Contamination of the coating or surface or improper abrasion for the coating.	<ol style="list-style-type: none"> 1. Be sure mixing equipment is clean. Avoid waxed mixing containers. 2. Be sure surface is properly prepared. Use proper grit sandpaper for the type of coating you are applying. (See paint or varnish manufacturer's instructions for proper surface preparation.) After surface is prepared, avoid contamination—fingerprints, exhaust fumes, rags with fabric softener (silicone). Coat within hours of preparation. After wet sanding, rinse water should sheet without beading (beading indicates contamination). Wipe with appropriate solvent and re-rinse until rinse water no longer beads. <p>Contact the Gougeon technical staff if you have additional questions.</p>
Hardener has turned red after several years storage.	Moisture in contact with hardener and metal container.	Red color is a normal condition. It will not affect epoxy handling or cured strength. Avoid using hardener for clear coating or exposed areas where color is not desired.

Problem solving notes

Removing epoxy

Removing uncured or non-curing epoxy. Uncured epoxy is removed as you would spilled resin. Scrape as much material as you can from the surface using a stiff metal or plastic scraper—warm the epoxy to lower its viscosity. Clean the residue with lacquer thinner, acetone, or alcohol. Be sure the solvent you choose does not attack the substrate. Follow safety warnings on solvents, and provide adequate ventilation. After re-coating wood surfaces with epoxy, it's a good idea to brush the wet epoxy (in the direction of the grain) with a wire brush to improve adhesion. Allow solvents to dry before re-coating.

Removing fiberglass cloth applied with epoxy. Use a heat gun to heat and soften the epoxy. Start in a small area near a corner or edge. Apply heat until you can slip a putty knife or chisel under the cloth (about 200°F). Grab the edge with a pair of pliers and pull up on the cloth while heating just ahead of the separation. On large areas, use a utility knife to score the glass and remove in narrower strips. Resulting surface texture may be coated or remaining epoxy may be removed as follows.

Removing cured epoxy coating. Use a heat gun to soften the epoxy (200°F). Heat a small area and use a paint or cabinet scraper to remove the bulk of the coating. Sand the surface to remove the remaining material. Provide ventilation when heating epoxy. Be sure the temperature will not affect the substrate.

Clamping

Any method of clamping is suitable as long as the parts to be joined are held so that movement will not occur. Don't use so much pressure that you squeeze all of the epoxy out of the joint. Common methods include spring clamps, "C" clamps and adjustable bar clamps, heavy rubber bands cut from inner tubes, nylon-reinforced packaging tape, applying weights, and vacuum bagging. When placing clamps near epoxy-covered areas, cover clamp pads with duct tape, or use polyethylene sheeting or release fabric under the clamps so they don't inadvertently bond to the surface. Staples, nails or drywall screws are often used where conventional clamps will not work. Any fasteners left in should be of a non-corroding alloy such as bronze. In some cases the thickened epoxy or gravity will hold parts in position without clamps.

Thinning epoxy

There are epoxy-based products specifically designed to penetrate and reinforce rotted wood. These products, basically an epoxy thinned with solvents, do a good job of penetrating wood. But the solvents compromise the strength and moisture barrier properties of the epoxy. WEST SYSTEM Epoxy can be thinned with solvents for greater penetration, but not without the same compromise in strength and moisture resistance. Acetone and lacquer thinner have been used to thin WEST SYSTEM Epoxy and duplicate these penetrating epoxies with about the same effectiveness. If you chose to thin the epoxy, keep in mind that the strength and moisture protection of the epoxy are lost in proportion to the amount of solvent added.

There is a better solution to get good penetration without losing strength or moisture resistance. We recommend moderate heating of the repair area with a heat gun or heat lamp. The epoxy will have a lower viscosity and penetrate more deeply when it contacts the warmed wood cavities and pores. Slower hardeners (206, 207, 209) will have a longer working life and will penetrate more than 205 Hardener before they begin to gel. When the epoxy cures, it will retain all of its strength and effectiveness as a moisture barrier, which we feel more than offsets any advantages gained by adding solvents to the epoxy.

Index

A

Abrasion, 6
 Abrasives, 123
 Active core, 8, 10
 Active drying, 70
 Adhesion, paint, 98
 Adhesive fillers, 107
 Alkyd finishes, 99
 Aluminum oxide, 123
 Aluminum, bonding to, 113
 Amine blush, 96
 Application methods, finish coatings, 98
 Applying fiberglass overhead, 135
 Automotive finishes, 99

B

Backing support, 20, 38
 Barrier coating, 78, 94
 Batten guide method, 88
 Batten, 84, 126
 Batten, making, 126
 Blister fluid, 59
 Blister prevention, 81
 Bonding problems, 142
 Bonding, 113

- Fasteners, 45
- Hardware, 46
- to Metal, 47
- with Fillets, 115

 Bottom paint, 100
 Bottom paint, removing, 68

C

Cabin sole, 8
 Casting epoxy base, 50
 Chalk stick, 84
 Chopped-strand mat, 1
 Clamping, 115, 144
 Cleanup, 105
 Clear coatings, 97
 Closed coat sandpaper, 123
 Coating compatibility, 98

Coating coverage, 132
 Coating hardness, 98
 Coating types, 99
 Cockpit sole, 8
 Cold temperature bonding, 129
 Construction methods, 2
 Controlling cure time, 108
 Cored laminate, 2
 Cores

- in Construction, 2
- Materials, 2
- Panel damage, 26
- Replacement, 2
- Replacing stringer, 10
- Stringer damage, 9

 Coverage, coating, 132
 Cracking, 5
 Cross-grain scratches, 85
 Crosslinking, 1
 Crystallization, 134
 Cure stages, 108
 Curing problems, 142

D

Dark colors, 97
 Delamination

- Repair, 13
- Skin/core, 26
- Sole and deck, 40
- Transom, 31

 Dispensing epoxy, 109
 Disposal, epoxy, 105
 Drying, 69
 Dust warning, 85

E

End-grain balsa core, 2
 Epoxy

- Barrier coating, 94
- Clean up, 105
- Cure stages, 108
- Handling, 107

Paint, 100
 Removing, 111
 Safety, 104

Ester linkage, 60
 Estimating guides, 132

F

Fair level, 83
 Fair, definition, 83
 Fairing

- Batten, 85
- Board, 86
- Board, making, 124
- Compound, preparing, 86
- Filler description, 107
- Fillers, 127
- Technique, 116

 Fastener bonding, 45
 Fiberglass

- Applying over stringers, 13
- Boat construction, 2
- in Construction, 1
- Reinforcing with, 14
- Skin repair, 19

 Fillers, description, 106
 Fillets, 115
 Final Fairing, 83
 Final surface preparation, 96
 Finish coatings, 96
 Finishing, 94
 Fish-eyeing, 142
 Flexible sanding board, making, 125
 Floors, 8
 Foam cores, 17
 Formulation variables, 60

G

Gelcoat blister formation, 58
 Gelcoat blister, problem, 58
 Gelcoat blisters, 3
 Gelcoat finish, 101
 Gelcoats, 2, 101

- Glossy finishes, 97
 Glycols, 2
 Graphite bearing, 56
 Grinding, 65
 Grits, sanding, 121
 Group sizes, 130
 Guide fairing methods, 88
- H**
 Half-round cores, 18
 Handling, 107
 Hardeners, 105
 Hazards, 104
 Heaters, 71
 High areas, removing, 84
 Holed panels, 37
 Hydraulic pressure, 60
 Hydrolysis damage, repair, 76
 Hydrolysis, 58
 Hydrolysis, description, 60
 Hydrolysis, repair, 67
- I**
 Inactive core, 9
 Inspecting blister damage, 64
 Interfacial adhesion, 61
 Interlaminar damage, 67
 Interlaminar damage, repair, 74
 Isolated blisters, repair, 72
- K**
 Keels
 External balast, 54
 Fairing, 90
 Internal balast, 53
 Lofting, 126
 Templating, 90
- L**
 Laminated stringers, 16
 Large voids, repair, 75
 Lead keel, 53
 Light colors, 97
 Local fairing, 92
 Lofting foil shapes, 128
- Lofting, 83
 Low areas, filling, 85
 Low temperature considerations, 129, 134
- M**
 Machined holes, repairing, 137
 Maintaining barrier coat, 82
 Mat, chopped strand, 1
 Matte finishes, 97
 MEE, 61
 MEKP, 1
 Micro-bubbles, 61
 Micro-cracking, 61
 Mini pumps, using, 109
 Minor blistering, 65
 Mixing epoxy, 109
 Mixing large quantities, 127
 Moisture barrier, 61
 Moisture content, 69
 Moisture meter, using, 69
 Moisture meters, sources, 126
- N**
 New boats, 68
 No-sand primers, 81
 Notched trowel method, 86
- O**
 Open coat sandpaper, 123
 Open time, 108
 Osmosis, 58
 Osmotic pressure, 60
- P**
 Paint finish, 102
 Panel core, 26
 Passive drying, 70
 Peeling gelcoat, 66
 Permeability, 59
 Peroxide catalyst, 1
 Pigmented coatings, 97
 Planks, teak, 44
 Plastic, bonding to, 113
- Plywood
 Sole/deck repair, 40
 Transom core, 31
 Polyester resin, 1
 Polyester, 1
 Polyurethane paint, 100
 Polyurethanes, 100
 Preparation
 for Barrier coating, 78
 for Bonding, 112
 for Finish coating, 96
 Primary bond, 62
 Primers, 101
 Problem solving, 142
- R**
 Re-coating, 120
 Recommendations, 62
 Reinforcing flexible panels, 14
 Reinforcing, 14
 Removable fasteners, 51
 Removing bonded fasteners, 51
 Removing epoxy, 111
 Removing fiberglass cloth, 144
 Repair patch, 20
 Resin, 105
 Roller cover brush, 123
 Rot
 Panel core, 26
 Stringer core, 9
 Roving, woven, 1
 Rudder bearings, 56
 Rudders, fairing, 90
 Rudders, lofting, 128
- S**
 Safety, 104
 Sandblasting, 66
 Screw fasteners, 48
 Secondary bond, 62
 Shelf life, 134
 Silicon carbide, 123
 Single-step bonding, 115
 Skin delamination, 26
 Skin, fiberglass, 19

Small voids, repair, 74
Sole, cockpit/cabin, 40
Solid laminate, 2
Solutes, 60
Sounding the hull, 66
Standard fairing method, 85
Standard method of filling, 85
Standard techniques, 104-120
Stringer
 Adding, 16
 Repair, 10
Stringer core, 9
Styrene, 2
Surface oxidation, 64
Surface preparation, 96, 112

T

Tabbing, 8, 41

Teak deck, installing, 42
Technique, 116
Template guide method, 90
Template transfer, 91
Templating foils, 90
Tenting, 70
Terminology, 3
Thinning epoxy, 144
Through-bolted fasteners, 47
Tipping off, 95
Tools, 123
Two-step bonding, 113

U

Unidirectional fiber, using, 18
Unsaturated polyester resin, 60
User Manual & Product Guide, 104
UV protection, 94, 97

V

Vacuum bagging, 25
Veneers, teak, 42
Voids in the laminate, 59

W

Waterborne coating, 99
Woven roving, 2

Z

Zirconia alumina, 123

Building and repair information available from WEST SYSTEM®

Publications

002-950 WEST SYSTEM User Manual & Product Guide

The primary guide to safety, handling and the basic techniques of epoxy use. It includes a complete description of WEST SYSTEM Epoxy resin, hardeners, fillers, additives, reinforcing materials, tools, supplies and publications.

002 The Gougeon Brothers on Boat Construction

This book is a must for anyone building a boat or working with wood and WEST SYSTEM Epoxy. Includes extensive chapters on composite construction techniques, materials, lofting, safety and tools, with many illustrations, diagrams and photographs.

002-970 Wooden Boat Restoration & Repair

An illustrated guide to restore the structure, improve the appearance, reduce the maintenance and prolong the life of wooden boats with WEST SYSTEM Epoxy. Includes information on dry rot repair, structural framework repair, hull and deck planking repair, hardware installation with epoxy and protective coating.

DVD

002-898 WEST SYSTEM Epoxy How-to DVD

An interactive compilation of three instructional videos. **Basic Application Techniques**, a video primer on WEST SYSTEM Epoxy Products and their use, includes safety procedures and application tips for coating, bonding and fairing. **Fiberglass Repair with WEST SYSTEM Epoxy** is a guide to structural repair on fiberglass boats. It covers repairs to cored and non-cored panels and how to apply gelcoat over epoxy repairs. **Gelcoat Blister Repair with WEST SYSTEM Epoxy** is a guide for repairing and preventing gelcoat blisters on fiberglass boats. It includes an analysis of the factors contributing to blister formation and steps for preparation, drying, repairing and coating for moisture protection.

Additional Reading

Composite Basis

by Andrew C. Marshall, published by Marshall Consulting, Walnut Creek, CA.
Technically oriented background on composite materials and design, mold making and fabrication techniques.

Fiberglass & Other Composite Materials

by Forbes Aird, published by The Berkley Publishing Group, NY, NY.
Automotive and marine oriented topics about fiber reinforced plastics (FRP), techniques, molds, materials and structures.

Handbook on Vacuum and Pressure Systems

Gast Mfg. Inc., A Unit of IDEX Corp., gastmfg.com

002-550 Fiberglass Boat Repair & Maintenance



Published by
Gougeon Brothers, Inc.
P.O. Box 908
Bay City, MI 48707
866-937-8797
westsystem.com

